

1W isolated DC-DC converter
Wide input voltage and regulated dual/single output



FEATURES

- Ultra compact SIP package
- Wide 2:1 input voltage range
- Operating ambient temperature range: -40°C to +85°C
- I/O isolation test voltage 3.0K VDC
- High power density
- Short circuit protection (self-recovery)
- Remote On/Off
- EN60950 approved

WRE_S-1WR2 & WRF_S-1WR2 series are isolated 1W DC-DC converter with 2:1 input voltage and conventional voltage output. The product has a relatively compact SIP plastic package, and features high efficiency, operating temperature of -40°C to +85°C. The smaller size and fine cost design make the converter an ideal solution in communication, instruments, and industrial electronics applications.

Selection Guide

Certification	Part No.	Input Voltage (VDC)		Output		Full Load Efficiency (%) Min./Typ.	Max. Capacitive Load ^② (μF)
		Nominal (Range)	Max. ^①	Voltage (VDC)	Current (mA) Max./Min.		
CE	WRE0505S-1WR2	5 (4.5-9)	11	±5	±100/±5	71/73	1000
	WRE0512S-1WR2			±12	±42/±2	74/76	470
	WRE0515S-1WR2			±15	±33/±2	73/75	330
	WRF0503S-1WR2			3.3	303/15	69/71	1800
	WRF0505S-1WR2			5	200/10	70/72	2200
	WRF0512S-1WR2			12	83/4	74/76	1000
	WRF0515S-1WR2			15	67/3	73/75	680
	WRE1205S-1WR2			12 (9-18)	20	±5	±100/±5
	WRE1212S-1WR2	±12	±42/±2			79/81	470
	WRE1215S-1WR2	±15	±33/±2			76/78	330
	WRF1203S-1WR2	3.3	303/15			73/75	2700
	WRF1205S-1WR2	5	200/10			75/77	2200
	WRF1209S-1WR2	9	111/6			77/79	1800
	WRF1212S-1WR2	12	83/4			77/79	1000
	WRF1215S-1WR2	15	67/3			78/80	680
	WRE2405S-1WR2	24 (18-36)	40	±5	±100/±5	77/79	1000
	WRE2412S-1WR2			±12	±42/±2	77/79	470
	WRE2415S-1WR2			±15	±33/±2	77/79	330
	WRF2403S-1WR2			3.3	303/15	73/75	2700
	WRF2405S-1WR2			5	200/10	75/77	2200
	WRF2412S-1WR2			12	83/4	76/78	1000
	WRF2415S-1WR2			15	67/3	76/78	680
	WRF2424S-1WR2			24	42/2	75/77	470
	WRE4805S-1WR2	48 (36-75)	80	±5	±100/±5	74/76	1000
	WRE4812S-1WR2			±12	±42/±2	76/78	470
	WRE4815S-1WR2			±15	±33/±2	78/80	330
	WRF4803S-1WR2			3.3	303/15	73/75	2700
	WRF4805S-1WR2			5	200/10	74/76	2200
WRF4812S-1WR2	12			83/4	78/80	1000	
WRF4815S-1WR2	15			67/3	77/79	680	

Notes: ① Exceeding the maximum input voltage may cause permanent damage;

② The specified maximum capacitive load for positive and negative output is identical.

Input Specifications

Item	Operating Conditions		Min.	Typ.	Max.	Unit
Input Current (full load/no-load)	5VDC Input	others	--	278/40	286/60	mA
		WRF0503S-1WR2	--	281/25	289/30	
	12VDC Input		--	107/15	110/30	
	24VDC Input		--	54/6	55/10	
	48VDC Input		--	27/4	28/6	
Reflected Ripple Current	5VDC Input		--	30	--	
	12VDC Input		--	40	--	
	24VDC Input		--	55	--	
	48VDC Input		--	45	--	
Surge Voltage (1sec. max.)	5VDC Input		-0.7	--	12	VDC
	12VDC Input		-0.7	--	25	
	24VDC Input		-0.7	--	50	
	48VDC Input		-0.7	--	100	
Start-up Voltage	5VDC Input		3.5	4	4.5	
	12VDC Input		4.5	8	9	
	24VDC Input		11	16	18	
	48VDC Input		24	33	36	
Input Filter	Capacitance filter					
Hot Plug	Unavailable					
Ctrl*	Module on		Ctrl pin open (high resistance)			
	Module off		Ctrl pin pulled high (current 5-10mA typ. into Ctrl.)			

Note: * For use of Ctrl, please refer to the "design reference" in this manual.

Output Specifications

Item	Operating Conditions		Min.	Typ.	Max.	Unit
Voltage Accuracy	5%-100% load	3.3V/5V output	--	±3	±5	
		WRF0503S-1WR2, others	--	±1	±3	
No-load Output Voltage Accuracy	Input voltage range		--	±1.5	±5	%
Linear Regulation	Input voltage variation from low to high at full load		--	±0.2	±0.5	
Load Regulation	5%-100% load		--	±0.4	±0.75	
Transient Recovery Time	25% load step change		--	0.5	2	ms
Transient Response Deviation			--	±2.5	±5	%
Temperature Coefficient	Full load		--	±0.02	±0.03	%/°C
Ripple & Noise *	20MHz bandw idth	WRF0503S-1WR2	--	75	100	mVp-p
		WRE/F05_S-1WR2, WRE/F24_S-1WR2	--	70	100	
		WRE/F12_S-1WR2, WRE/F48_S-1WR2	--	100	150	
Short-circuit Protection	Continuous, self-recovery					

Note: *The "parallel cable" method is used for ripple and noise test, please refer to DC-DC Converter Application Notes for specific information.

General Specifications

Item	Operating Conditions	Min.	Typ.	Max.	Unit
Isolation	Input-output Electric Strength Test for 1 minute with a leakage current of 1mA max.	3000	--	--	VDC
Insulation Resistance	Input-output resistance at 500VDC	1000	--	--	MΩ
Isolation Capacitance	Input-output capacitance at 100KHz/0.1V	--	30	50	pF
Operating Temperature	see Fig. 1	-40	--	+85	°C
Storage Temperature		-55	--	+125	
Case Temperature Rise	Ta=25°C, nominal input, full load	--	+25	--	

Pin Soldering Resistance Temperature	Soldering spot is 1.5mm away from case for 10 seconds	--	--	+300	°C
Storage Humidity	Non-condensing	--	--	95	%RH
Switching Frequency (PFM Mode)	Full load, nominal input voltage	--	200	--	KHz
MTBF	MIL-HDBK-217F@25°C	1000	--	--	K hours

Mechanical Specifications

Case Material	Black plastic; flame-retardant and heat-resistant (UL94-V0)
Dimensions	22.00 x 9.50 x 12.00 mm
Weight	4.9g(Typ.)
Cooling Method	Free air convection

Electromagnetic Compatibility (EMC)

Emissions	CE	CISPR32/EN55032	CLASS B (see Fig. 3-② for recommended circuit)
	RE	CISPR32/EN55032	CLASS B (see Fig. 3-② for recommended circuit)
Immunity	ESD	IEC/EN61000-4-2	Contact ±4KV perf. Criteria B
	RS	IEC/EN61000-4-3	10V/m perf. Criteria A
	EFT	IEC/EN61000-4-4	±2KV (see Fig. 3-① for recommended circuit) perf. Criteria B
	Surge	IEC/EN61000-4-5	line to line ±2KV (see Fig. 3-① for recommended circuit) perf. Criteria B
	CS	IEC/EN61000-4-6	3 Vr.m.s perf. Criteria A
	Voltage dips, short interruptions and voltage variations immunity	IEC/EN61000-4-29	0%, 70% perf. Criteria B

Typical Characteristic Curves

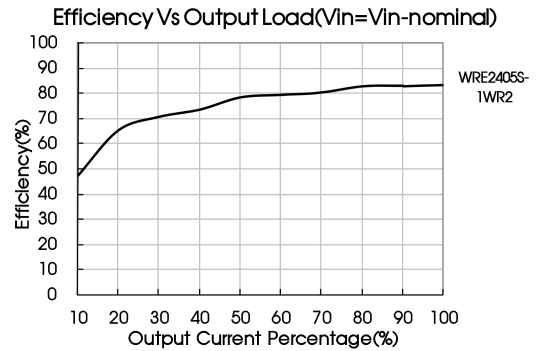
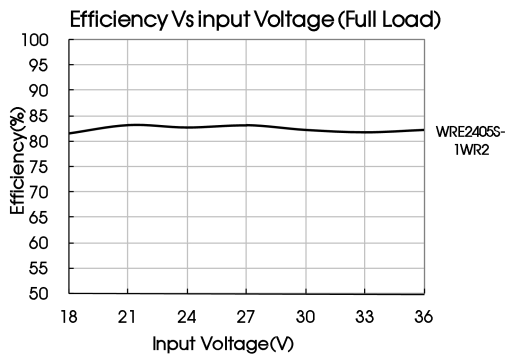
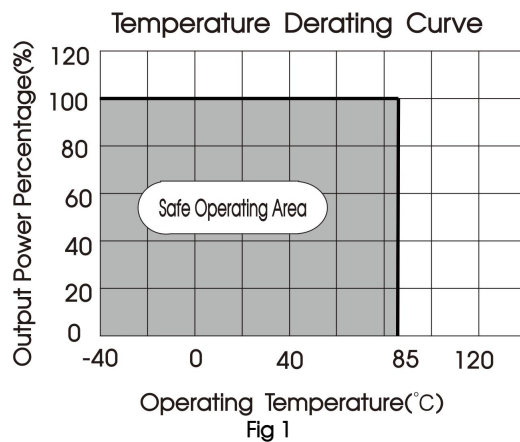

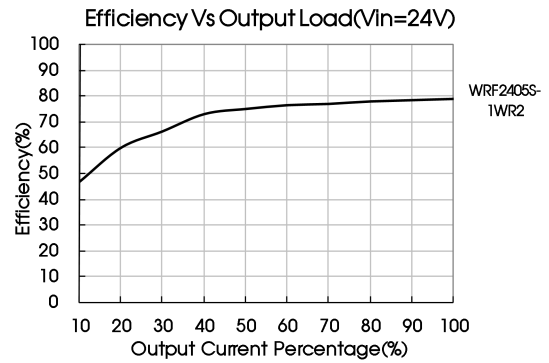
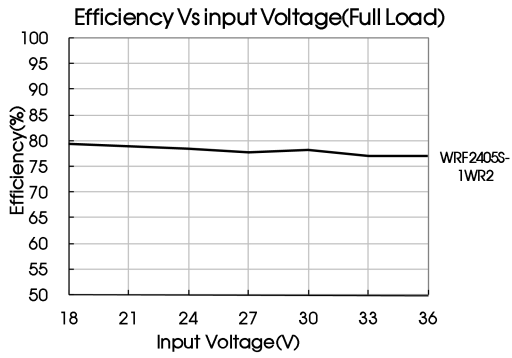

Design Reference

1. Typical application

All the DC/DC converters of this series are tested before delivery using the recommended circuit shown in Fig. 2.

Input and/or output ripple can be further reduced by appropriately increasing the input & output capacitor values C_{in1} , C_{in2} , C_s and C_{out} and/or by selecting capacitors with a low ESR (equivalent series resistance). C_s is used to reduce ripple. No need to add C_s , if ripple meets the demand. Appropriate filter capacitance shall be chosen, start-up problems may be caused if the capacitance is too large. For each output circuit, under the condition of safe and reliable operation, the max. capacity of its filter capacitor should be lower than the max. capacitive load.

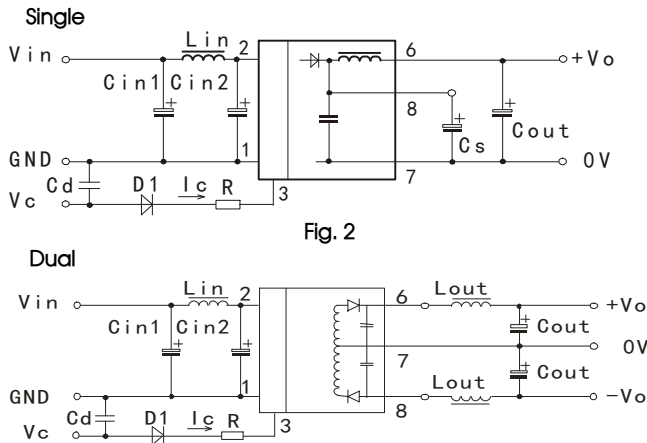

Fig. 2

Pin	5VDC&12VDC	24VDC&48VDC
Cin1	100 μ F	10 μ F
Cin2	47 μ F	1 μ F
Lin	4.7 μ H-12 μ H	
Cs	10 μ F-22 μ F	
Cout	100 μ F(Typ.)	
Cd	47nF/100V	

2. EMC compliance circuit

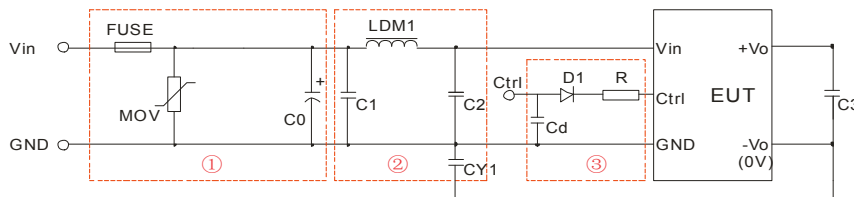

Fig. 3

Parameter description:

Model	Vin:5VDC	Vin:12VDC	Vin:24VDC	Vin:48VDC
FUSE	Slow-blow, selecting based on needs			
MOV	--	--	S14K35	S14K60
LDM1	--	--	56 μ H	56 μ H
C0	680 μ F/16V	680 μ F/25V	330 μ F/50V	330 μ F/100V
C1	4.7 μ F/50V			4.7 μ F/100V
C2	4.7 μ F/50V			4.7 μ F/100V
C3	Refer to the Cout in Fig.2			
CY1	1nF/3KV			
D1	RB160M-60V/1A			

R	In accordance with the formula: $R = \frac{V_C - V_D - 1.0}{I_C} - 300$
Cd	47nF/100V

- Notes:
- ① For EMC tests we use Part ① in Fig. 3 for immunity and part ② for emissions test. Selecting based on needs.
 - ② V_C is the voltage of the Ctrl end relative to the GND of the input grounding; V_D is the positive-going conduction pressure drop of D1; I_C is the current flows into the Ctrl end and its value is generally 5-10mA, see Fig. 3-③ for the peripheral circuit of Ctrl end;
 - ③ If there is no recommended parameters, no external component is required.

3. Ctrl end

The modules are of normal output when the Ctrl end is suspended or of high resistance; the modules turn off when connecting with high level (relative to the input grounding); notice that the current flows into the pin shall be 5 - 10mA, the modules will be permanently damaged if the current exceeds its max. value (20mA in general).

The value of R can be derived as follows:

$$R = \frac{V_C - V_D - 1.0}{I_C} - 300$$

For Detailed parameter, please refer to EMC compliance circuit in this manual.

4. Input current

When the electricity is provided by the unstable power supply, please make sure that the range of the output voltage fluctuation and the ripple voltage of the power supply do not exceed the indicators of the modules. Input current of power supply should afford the flash startup current of this kind of DC/DC module(see Fig. 5).

- Generally: $V_{in} = 5V$ series $I_{ave} = 445mA$ (WRF0503S-1WR2 $I_{ave} = 450mA$)
 $V_{in} = 12V$ series $I_{ave} = 205mA$
 $V_{in} = 24V$ series $I_{ave} = 104mA$
 $V_{in} = 48V$ series $I_{ave} = 53mA$

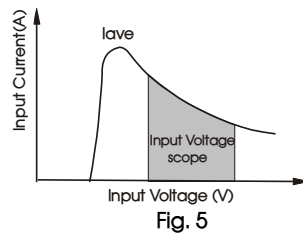

5. Output load requirements

When using, the minimum load of the module output should not be less than 5% of the nominal load. In order to meet the performance parameters of this datasheet, please connect a 5% dummy load in parallel at the output end, the dummy load is generally a resistor, please note that the resistor needs to be used in derating.

6. For additional information please refer to DC-DC converter application notes on

www.mornsun-power.com

Dimensions and Recommended Layout

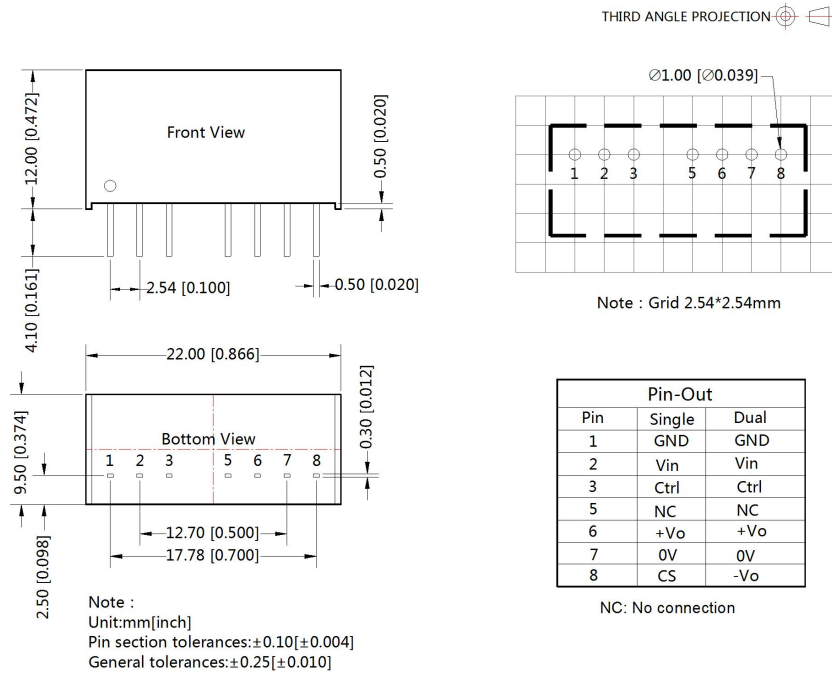

Notes:

1. For additional information on Product Packaging please refer to www.mornsun-power.com. Packing bag number: 58210004;
2. Recommend to use module with more than 5% load, if not, the ripple of the product may exceeds the specification, but does not affect the reliability of the product;
3. The recommended unbalance degree of the dual output module load is $\leq \pm 5\%$; if the degree exceeds $\pm 5\%$, than the product performance cannot be guaranteed to comply with all parameters in the datasheet. Please contact our technicians directly for specific information;
4. The maximum capacitive load offered were tested at input voltage range and full load;
5. Unless otherwise specified, parameters in this datasheet were measured under the conditions of $T_a=25^\circ\text{C}$, humidity<75%RH with nominal input voltage and rated output load;
6. All index testing methods in this datasheet are based on company corporate standards;
7. We can provide product customization service, please contact our technicians directly for specific information;
8. Products are related to laws and regulations: see "Features" and "EMC";
9. Our products shall be classified according to ISO14001 and related environmental laws and regulations, and shall be handled by qualified units.

Mornsun Guangzhou Science & Technology Co., Ltd.

Address: No. 5, Kehui St. 1, Kehui Development Center, Science Ave., Guangzhou Science City, Huangpu District, Guangzhou, P. R. China
Tel: 86-20-38601850 Fax: 86-20-38601272 E-mail: info@mornsun.cn www.mornsun-power.com