

15W, Ultra wide input isolated & regulated dual output ,
DIP packaging, DC-DC converter

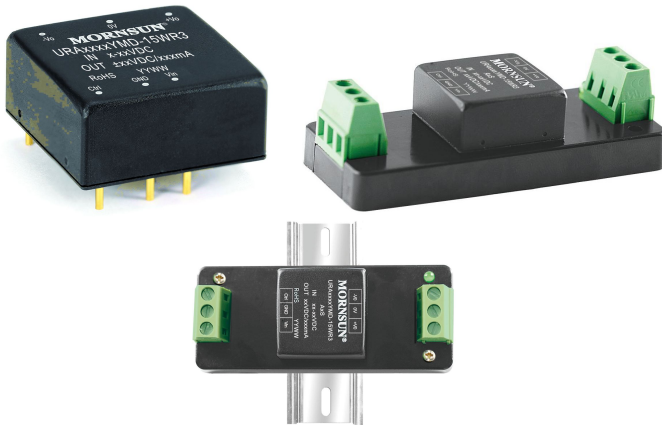

Patent Protection RoHS



URA_YMD-15WR3 series are isolated 15W DC-DC products with 4:1 input voltage. They feature efficiency up to 90%, 1500VDC isolation, operating temperature of -40°C to +105°C, input under-voltage protection, output over-voltage, over-current, short circuit protection and EMI meets CISPR32/EN55032 CLASS A, which make them widely applied in industrial control, electric power, instruments and communication fields. And extension package A2S and A4S also enable them with reverse voltage protection.

FEATURES

- Ultra wide input voltage range (4:1)
- High efficiency up to 90%
- No-load power consumption as low as 0.24W
- Isolation voltage :1.5K VDC
- Input under-voltage protection, output short circuit, over-current, over-voltage protection
- Operating temperature range: -40°C to +105°C
- Meet CISPR32/EN55032 CLASS A, without external components
- A2S (wiring mounting) and A4S (TS35 rail mounting) products featuring anti-reverse connection for input
- International standard pin-out
- Meets EN62368 standards (Pending)

Selection Guide

Certification	Part No. ①	Input Voltage (VDC)		Output		Efficiency ④ (% Min./Typ.) @ Full Load	Max. Capacitive Load ⑤ (μF)
		Nominal ② (Range)	Max. ③	Output Voltage (VDC)	Output Current (mA) (Max./Min.)		
CE Pending	URA2405YMD-15WR3	24 (9-36)	40	±5	±1500/0	85/87	1500
	URA2412YMD-15WR3			±12	±625/0	88/90	470
	URA2415YMD-15WR3			±15	±500/0	88/90	330
	URA2424YMD-15WR3			±24	±312/0	87/89	200
	URA4805YMD-15WR3	48 (18-75)	80	±5	±1500/0	84/86	1500
	URA4812YMD-15WR3			±12	±625/0	88/90	470
	URA4815YMD-15WR3			±15	±500/0	88/90	330
	URA4824YMD-15WR3			±24	±312/0	88/90	200

Notes:

- ① Part No. with suffix of "A2S" means chassis mounting and suffix of "A4S" means DIN-Rail mounting(e.g. URA2405YMD-15WR3A2S means chassis mounting; URA2405YMD-15WR3A4S means DIN-Rail mounting);
- ② The minimum input voltage and starting voltage of A2S (wiring) and A4S (rail) Model are 1VDC higher than those of DIP package due to input reverse polarity protection function;
- ③ Absolute maximum rating without damage on the converter, but it isn't recommended;
- ④ Efficiency is measured in nominal input voltage and rated output load; A2S (wiring) and A4S (rail) Model due to input reverse polarity protection, minimum efficiency greater than Min.-2 is qualified;
- ⑤ The capacitive loads of positive and negative outputs are identical.

Input Specifications

Item	Operating Conditions	Min.	Typ.	Max.	Unit
Input Current (full load / no-load)	24VDC nominal input series, nominal input voltage	--	958/10	--/20	mA
	48VDC nominal input series, nominal input voltage	--	969/5	--/11	
Reflected Ripple Current		--	30	--	
Surge Voltage (1sec. max.)	24VDC nominal input series	-0.7	--	50	VDC
	48VDC nominal input series	-0.7	--	100	
Starting Voltage	24VDC nominal input series	--	--	9	
	48VDC nominal input series	--	--	18	
Input Under-voltage Protection	24VDC nominal input series	5.5	6.5	--	VDC
	48VDC nominal input series	12	15.5	--	

Starting Time	Nominal input voltage & constant resistance load	--	10	--	ms
Input Filter		PI filter			
Hot Plug		Unavailable			
Ctrl*	Module switch on	Ctrl suspended or connected to TTL high level (3.5-12VDC)			
	Module switch off	Ctrl pin connected to GND or low level (0-1.2VDC)			
	Input current when switched off	--	2	7	mA

Note: *The voltage of Ctrl pin is relative to input pin GND.

Output Specifications

Item	Operating Conditions	Min.	Typ.	Max.	Unit	
Output Voltage Accuracy ^①	5%-100% load	--	±1	±3	%	
Line Regulation	Full load, the input voltage is from low voltage to high voltage	Positive output	--	±0.2		±0.5
		Negative output	--	±0.4		±1
Load Regulation ^②	5%-100% load	--	±0.5	±1		
Cross Regulation	Dual output, main circuit with 50% load, auxiliary circuit with 10%-100% load	--	--	±5		
Transient Recovery Time	25% load step change, nominal input voltage	All products	--	300	500	μs
Transient Response Deviation		5V output	--	±3	±8	%
		Others	--	±3	±5	
Temperature Coefficient	Full load	--	--	±0.03	%/°C	
Ripple & Noise ^③	20MHz bandwidth, 5%-100% load	--	100	200	mV p-p	
Output Over-voltage Protection	Input voltage range	110	--	160	%Vo	
Output Over-current Protection		110	200	270	%Io	
Short circuit Protection		Continuous, self-recovery				

Note: ①At 0%-5% load, the Max. output voltage accuracy converter is ±5%.
 ②When testing from 0% to 100% load working conditions, load regulation index of ±5%;
 ③0%-5% load ripple & Noise is no more than 5%Vo. Ripple and noise are measured by "parallel cable" method, please see DC-DC Converter Application Notes for specific operation.

General Specifications

Item	Operating Conditions	Min.	Typ.	Max.	Unit
Insulation Voltage	Input-output, with the test time of 1 minute and the leak current lower than 1mA	1500	--	--	VDC
	Input and output respectively on the shell, with the test time of 1 minute and the leak current lower than 1mA.	1000	--	--	
Insulation Resistance	Input-output, insulation voltage 500VDC	1000	--	--	MΩ
Isolation Capacitance	Input-output, 100KHz/0.1V	--	2000	--	pF
Operating Temperature	see Fig. 1	-40	--	+105	°C
Storage Temperature		-55	--	+125	
Storage Humidity	Non-condensing	5	--	95	%RH
Lead Temperature	Welding spot is 1.5mm away from the casing, 10 seconds	--	--	+300	°C
Vibration		10-150Hz, 5G, 0.75mm. along X, Y and Z			
Switching Frequency	PWM mode	--	270	--	KHz
MTBF	MIL-HDBK-217F@25°C	1000	--	--	K hours

Note: *This series of products with reduced frequency technology. The switching frequency of the full test, when the load is light, the switching frequency decline.

Physical Specifications

Casing Material	Aluminum alloy				
Dimension	Horizontal package	25.40*25.40*11.70 mm			
	A2S chassis mounting	76.00*31.50*21.20 mm			
	A4S DIN-rail mounting	76.00*31.50*25.80 mm			

Weight	Horizontal package/A2S wiring package/A4S rail package	15g/35g/55g (Typ.)
Cooling method	Free air convection	

EMC Specifications

EMI	CE	CISPR32/EN55032	CLASS A (Without external components)/ CLASS B (see Fig.3-② for recommended circuit)
	RE	CISPR32/EN55032	CLASS A (Without external components)/ CLASS B (see Fig.3-② for recommended circuit)
EMS	ESD	IEC/EN61000-4-2	Contact $\pm 4\text{KV}$ perf. Criteria B
	RS	IEC/EN61000-4-3	10V/m perf. Criteria A
	EFT	IEC/EN61000-4-4	$\pm 2\text{KV}$ (see Fig.3-① for recommended circuit) perf. Criteria B
	Surge	IEC/EN61000-4-5	line to line $\pm 2\text{KV}$ (see Fig.3-① for recommended circuit) perf. Criteria B
	CS	IEC/EN61000-4-6	3 Vr.m.s perf. Criteria A

Product Characteristic Curve

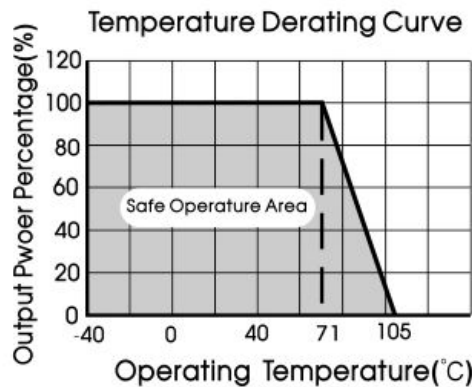
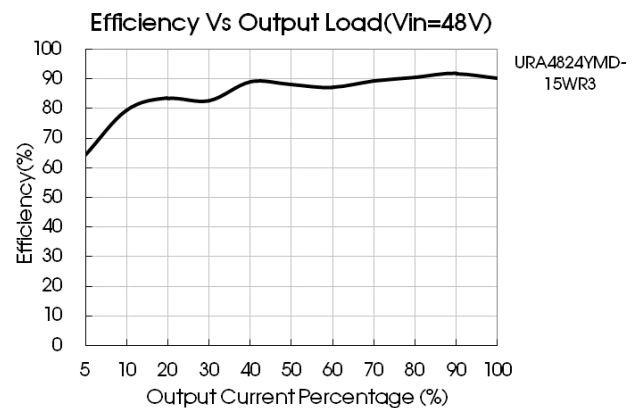
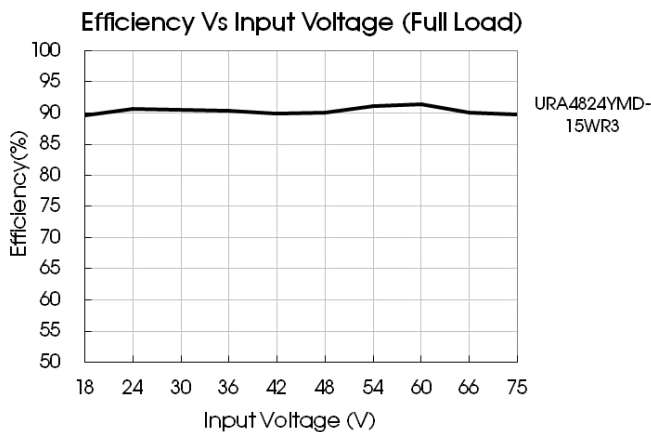
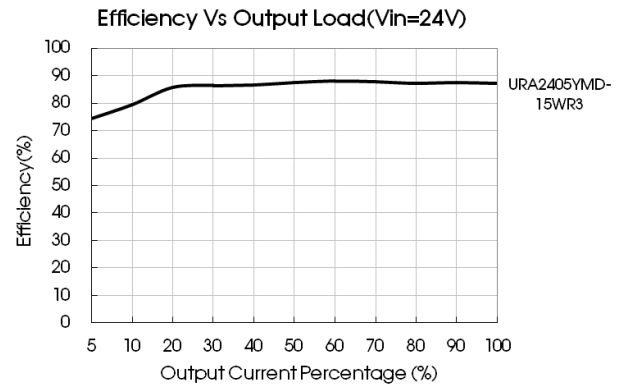
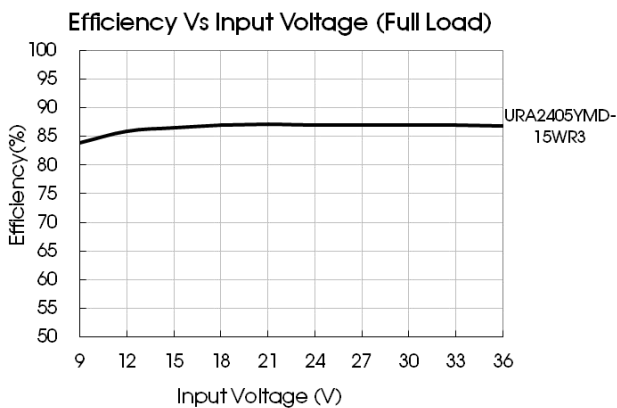

Fig. 1



Design Reference

1. Typical application

All the DC/DC converters of this series are tested according to the recommended circuit (see Fig. 2) before delivery. If it is required to further reduce input and output ripple, properly increase the input & output of additional capacitors Cin and Cout or select capacitors of low equivalent impedance provided that the capacitance is no larger than the max. capacitive load of the product.

Dual Output

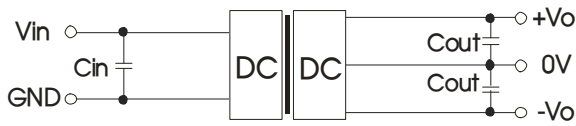

Fig. 2

Vin	24V	48V
Cin1	100μF	10μF -47μF
Cout	10μF	

2. EMC solution-recommended circuit

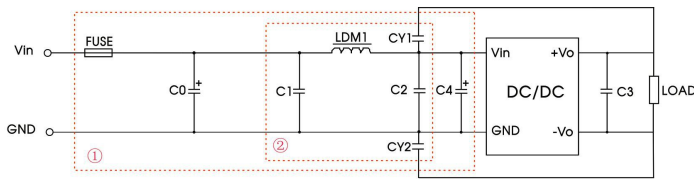

Fig. 3

Notes: Part ① in the Fig. 3 is used for EMC test and part ② for EMI filtering; selected based on needs.

Parameter description:

Model	Vin:24V	Vin:48V
FUSE	Choose according to actual input current	
C0, C4	330μF/50V	330μF/100V
C1, C2	4.7μF/50V	4.7μF/100V
C3	Refer to the Cout in Fig.2	
LDM1	4.7μH	
CY1, CY2	1nF/2KV	

3. It is not allowed to connect modules output in parallel to enlarge the power

4. For more information please find DC-DC converter application notes on www.mornsun-power.com

Dimensions and Recommended Layout

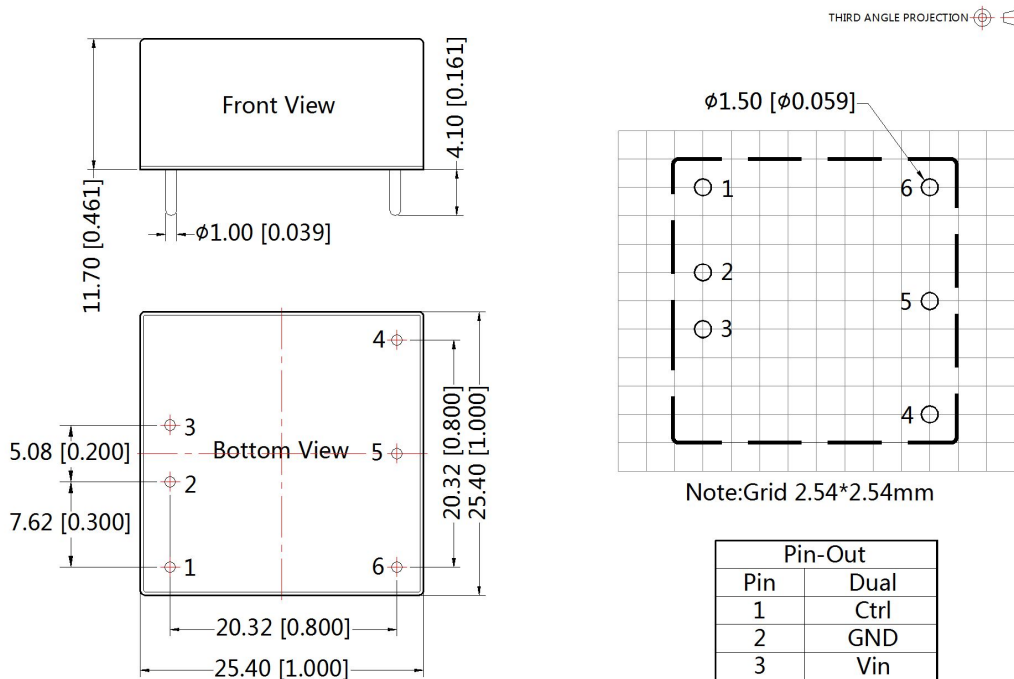

Note:
Unit: mm[inch]
Pin diameter tolerances: ±0.10[±0.004]
General tolerances: ±0.50[±0.020]

URB_YMD-20WR3A2S Dimensions

THIRD ANGLE PROJECTION

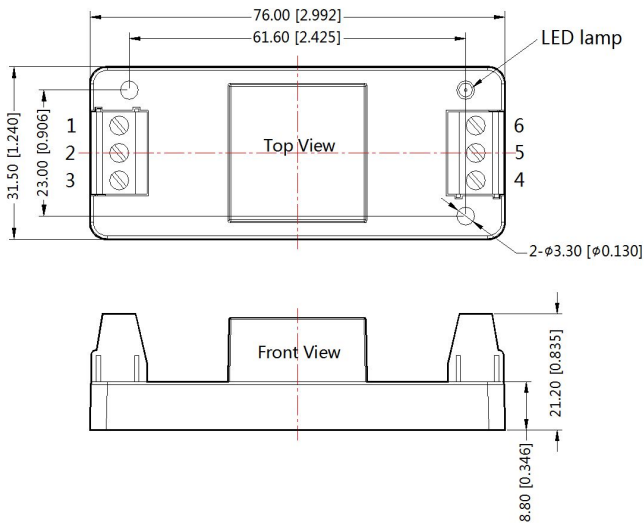

Pin-Out						
Pin	1	2	3	4	5	6
Function	Ctrl	GND	Vin	+Vo	0V	-Vo

Note:
Unit: mm[inch]
Wire range: 24-12 AWG
Tightening torque: Max 0.4 N·m
General tolerances: ±1.00[±0.039]

URB_YMD-20WR3A4S Dimensions

THIRD ANGLE PROJECTION

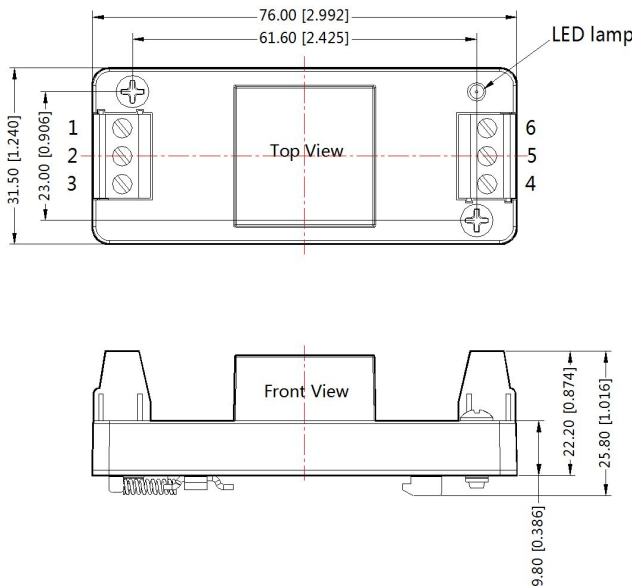

Pin-Out						
Pin	1	2	3	4	5	6
Function	Ctrl	GND	Vin	+Vo	0V	-Vo

Note:
Unit: mm[inch]
Mounting rail: TS35
Wire range: 24-12 AWG
Tightening torque: Max 0.4 N·m
General tolerances: ±1.00[±0.039]

- Note:
1. Packing information please refer to Product Packing Information which can be downloaded from www.mornsun-power.com. Packing bag number : 58210003 (DIP), 58220022(A2S/A4S package);
 2. The maximum capacitive load offered were tested at input voltage range and full load;
 3. Unless otherwise specified, parameters in this datasheet were measured under the conditions of Ta=25°C, humidity<75%RH with nominal input voltage and rated output load;
 4. All index testing methods in this datasheet are based on Company's corporate standards;
 5. We can provide product customization service, please contact our technicians directly for specific information;
 6. Products are related to laws and regulations: see "Features" and "EMC";
 7. Our products shall be classified according to ISO14001 and related environmental laws and regulations, and shall be handled by qualified units.

Mornsun Guangzhou Science & Technology Co., Ltd.

Address: No. 5, Kehui St. 1, Kehui Development Center, Science Ave., Guangzhou Science City, Luogang District, Guangzhou, P. R. China
Tel: 86-20-38601850-8801 Fax: 86-20-38601272 E-mail: info@mornsun.cn