

## Wire Wound Chip Inductors

### SWI1008CT/FT-KI Series



## INTRODUCTION

The SWI series are wire wound chip inductors widely used in the communication applications such as cellular phones, cable modem, ADSL, repeaters, Bluetooth, and other electronic devices. The wire wound inductors advance in higher self resonate frequency, better Q factor, and much more stable performance.

## FEATURES

- Operating temperature -40 to +125°C for ceramic series and -40 to +85°C for ferrite series.
- Excellent solderability and resistance to soldering heat.
- Suitable for reflow soldering.
- High reliability and easy surface mount assembly.
- Wide range of inductance values are available for flexible needs.

## PART NUMBER

SWI 1008 C T 1R0 J - □□

1 2 3 taping 4 5 6

1 Product Type

2 Chip Dimension

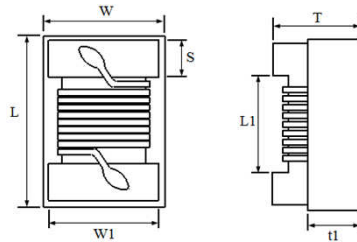

Size (inch) mm	Length (L) (inch) mm	Width (W) (inch) mm	Thickness (T) (inch) mm	Terminal (S) (inch) mm	(t <sub>1</sub> ) (Ref.) mm
SWI 1008 2520	(0.102 ± 0.008) 2.60 ± 0.20	(0.083 ± 0.008) 2.10 ± 0.20	(0.067 ± 0.008) 1.70 ± 0.20	(0.020 ± 0.004) 0.50 ± 0.10	0.70

3 Material Type C : Ceramic F : Ferrite

4 Inductance Value 1R0 = 1.0uH 100 = 10uH

5 Tolerance G = ±2% J = ±5% K = ±10%

6 Internal Code

**1** Scope

This specification applies to fixed inductors of the following types used in electronic equipment :

- \*Ceramic Type : For lower inductance with high Q factor at high frequency and stable circuit requirement.
- \*Ferrite Type : For higher inductance at lower frequency circuit requirement.

**2** Construction

- \*Configuration & Dimension : Please refer to the attached figures and tables.
- \*Terminals : Consist of Ag alloy followed by Nickel, then Au or Sn plating for easier soldering.

**3** Operating Temperature Range

Operating Temperature Range is the scope of ambient temperature at which the inductor can be operated continuously at rated current.

- \*Temp. Range : Ceramic material : -40°C ~ +125°C
- : Ferrite material : -40°C ~ +85°C

**4** Ingredient of terminals electrode

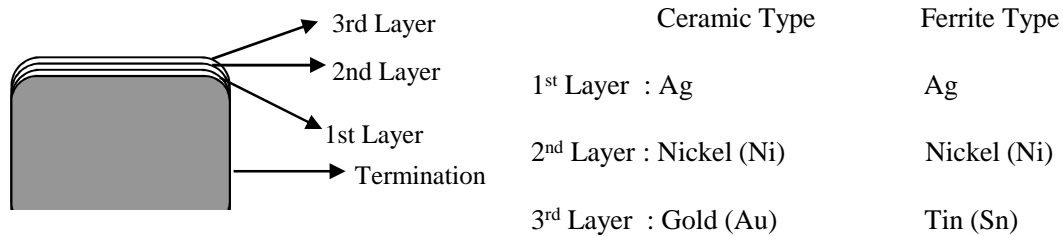

**5** Characteristics

Standard Atmospheric Conditions

Unless otherwise specified, the standard range of atmospheric conditions for making measurements and tests are as follows:

- Ambient Temperature : 25°C ± 2°C
- Relative Humidity : 60% to 70%
- Air Pressure : 86Kpa to 106Kpa

Temperature Profile

**1** Reflow Temperature Profile

(Temperature of the mounted parts surface on the printed circuit board)

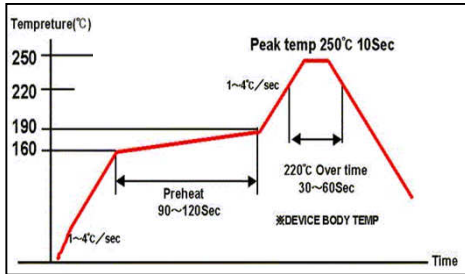

Recommended Peak Temperature : 250°C Max  
250°C up /within 10secs  
Max. Reflow temperature : 260°C  
Gradient of temperature rise : av 1-4°C/sec  
Preheat : 160-190°C/within 90-120secs  
220°C up /within 30-60secs  
Composition of solder Sn-3Ag-0.5Cu

**2** Dip Temperature

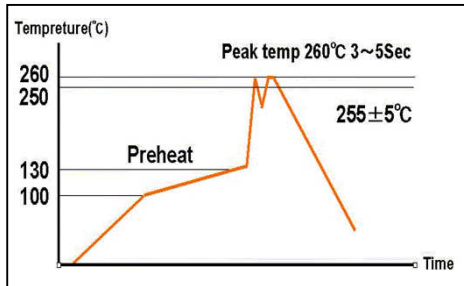

Solder bathtub temperature : 260°C max  
within 5secs.  
Preheating temperature : 100~130°C  
deposit solder temperature.  
Composition of solder Sn-3Ag-0.5Cu

**3** Soldering iron tip temperature : 350°C max / within 3 seconds.

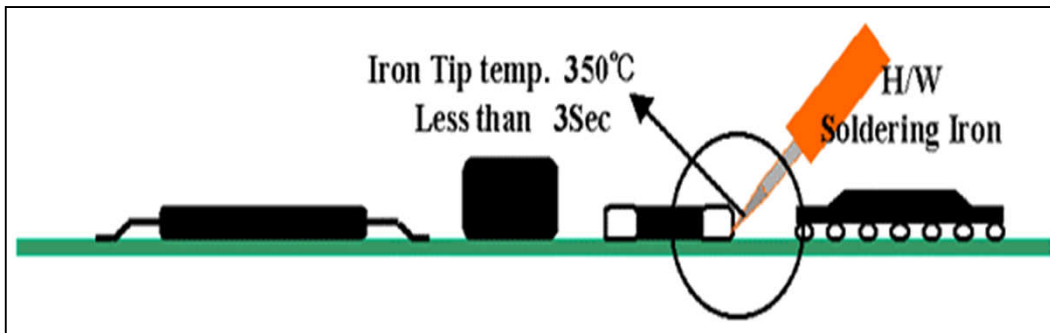

## SWI1008CT/FT-KI Series

Part No.	Inductance <sup>1</sup> (uH)	Tolerance	Q <sup>2</sup> Min	S.R.F. <sup>3</sup> Min (MHz)	RDC <sup>4</sup> Max (Ω)	IDC <sup>5</sup> Max (mA)	Marking
SWI1008CT R47 □-KI	0.47 @ 25MHz	K, J	45 @ 100MHz	450	1.18	470	R47
SWI1008CT R56 □-KI	0.56 @ 25MHz	K, J	45 @ 100MHz	415	1.33	450	R56
SWI1008CT R68 □-KI	0.68 @ 25MHz	K, J	40 @ 100MHz	375	1.20	480	R68
SWI1008CT R75 □-KI	0.75 @ 25MHz	K, J	40 @ 100MHz	360	1.50	420	R75
SWI1008CT R82 □-KI	0.82 @ 25MHz	K, J	40 @ 100MHz	350	1.60	400	R82
SWI1008CT 1R0 □-KI	1.0 @ 25MHz	K, J	30 @ 50MHz	180	1.70	370	1R0
SWI1008FT 1R2 □-KI	1.2 @ 7.96MHz	K, J	20 @ 7.96MHz	280	0.50	760	1R2
SWI1008FT 1R5 □-KI	1.5 @ 7.96MHz	K, J	20 @ 7.96MHz	250	0.75	630	1R5
SWI1008FT 1R8 □-KI	1.8 @ 7.96MHz	K, J	20 @ 7.96MHz	200	0.75	630	1R8
SWI1008FT 2R2 □-KI	2.2 @ 7.96MHz	K, J	20 @ 7.96MHz	160	1.10	520	2R2
SWI1008FT 2R7 □-KI	2.7 @ 7.96MHz	K, J	20 @ 7.96MHz	135	1.10	520	2R7
SWI1008FT 3R3 □-KI	3.3 @ 7.96MHz	K, J	20 @ 7.96MHz	120	1.35	460	3R3
SWI1008FT 3R9 □-KI	3.9 @ 7.96MHz	K, J	20 @ 7.96MHz	105	1.50	420	3R9
SWI1008FT 4R7 □-KI	4.7 @ 7.96MHz	K, J	20 @ 7.96MHz	60	1.65	400	4R7
SWI1008FT 5R6 □-KI	5.6 @ 7.96MHz	K, J	20 @ 7.96MHz	80	1.80	370	5R6
SWI1008FT 6R8 □-KI	6.8 @ 7.96MHz	K, J	20 @ 7.96MHz	70	2.00	360	6R8
SWI1008FT 8R2 □-KI	8.2 @ 7.96MHz	K, J	20 @ 7.96MHz	50	2.60	320	8R2
SWI1008FT 100 □-KI	10 @ 2.52MHz	K, J	15 @ 2.52MHz	40	2.80	300	100

1. Inductance is measured in HP-4287A RF LCR meter with HP-16193 fixture.
2. Q is measured in HP-4287A RF LCR meter with HP-16193 fixture.
3. SRF is measured in ENA E5071B network analyzer or equivalent.

4. RDC is measured in HP-4338B milliohmeter or equivalent.

5. For 15 °C Rise.

Remarks :

Unit weight = 0.025g (for ref.)

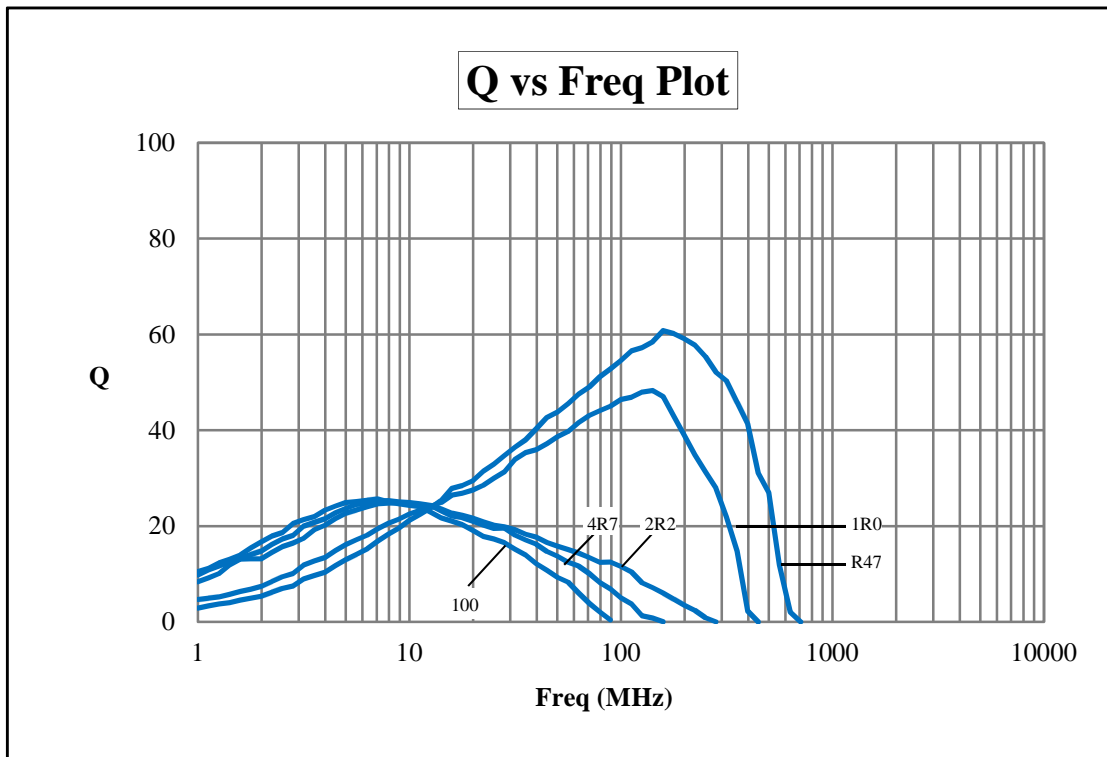
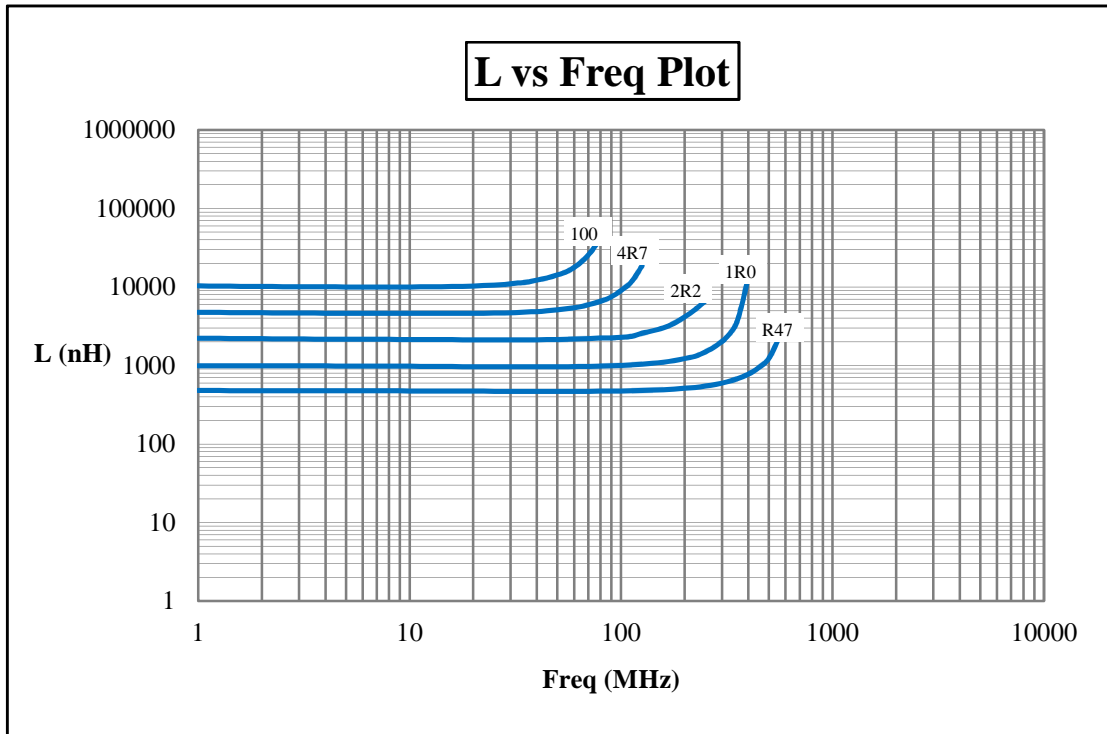

ITEM		CONDITION	SPECIFICATION
<b>Electrical Characteristics</b>	Inductance and Tolerance	Measuring Frequency : As shown in Product Table	Within Specified Tolerance
	Quality Factor	Measuring Temperature : +25°C	
	Insulation Resistance	Measured at 100V DC between inductor terminals and center of case.	1000 mega ohms minimum
	Dielectric Withstanding Voltage	Measured at 500V AC between inductor terminals and center of case for a maximum of 1 minute.	No damage occurs when the test voltage is applied.
	Temperature Coefficient of Inductance (TCL)	Over -40°C to +85°C at frequency specified in Product Table.	+25 to 500 ppm/°C $TCL = \frac{L1 - L2}{L1(T1 - T2)} \times 10^6$ (ppm /°C)
<b>Mechanical Characteristics</b>	Component Adhesion (Push Test)	The component shall be reflow soldered onto a P.C. Board ( 240°C ± 5°C for 20 seconds ). Then a dynamometer force gauge shall be applied to any side of the component.	Minimum 1Kg
	Drop Test	The inductor shall be dropped two times on the concrete floor or the vinyl tile from 1M naturally.	Change In Inductance: No more than 5%
	Thermal Shock Test	Each cycle shall consist of 30 minutes at -40°C followed by 30 minutes at +85°C with a 5 minutes transition time between temperature extremes. Test duration is 10 cycles.	Change In Q: No more than 10% Change In Appearance: Without distinct damage
<b>Endurance Characteristics</b>	Solderability	Dip pads in flux and dip in solder pot containing lead free solder at 240°C ± 5°C for 5 seconds.	A minimum of 80% of the metalized area must be covered with solder.
	Resistance to Soldering Heat	Dip the components into flux and dip into solder pot containing lead free solder at 260°C ± 5°C for 5 ± 2 seconds.	Change In Inductance: No more than 5% Change In Q: No more than 10% Change In Appearance: Without distinct damage
	Vibration (Random)	Inductors shall be randomly vibrated at amplitude of 1.5mm and frequency of 10-55Hz : 0.04G/Hz for a minimum of 15 minutes per axis for each of the three axes.	
	Cold Temperature Storage	Inductors shall be stored at temperature of -40°C ± 2°C for 1000hrs (+48 -0 hrs.) Then inductors shall be subjected to standard atmospheric conditions for 1 hour. After that, measurement shall be made.	
	High Temperature Storage	Inductors shall be stored at temperature of 85°C ± 2°C for 1000hrs (+48 -0 hrs.) Then inductors shall be subjected to standard atmospheric conditions for 1 hour. After that, measurement shall be made.	
	Moisture Resistance	Inductors shall be stored in the chamber at 45°C at 90-95 R.H. for 1000 hours. Then inductors are to be tested after 2 hours at room temperature.	Inductors shall not have a shorted or open winding.
	High Temperature with Loaded	Inductors shall be stored in the chamber at +85°C for 1000 hours with rated current applied. Inductors shall be tested at the beginning of test at 500 hours and 1000 hours. Then inductors are to be tested after 1 hour at room temperature.	

Type	Pcs/Reel
SWI1008	2,000

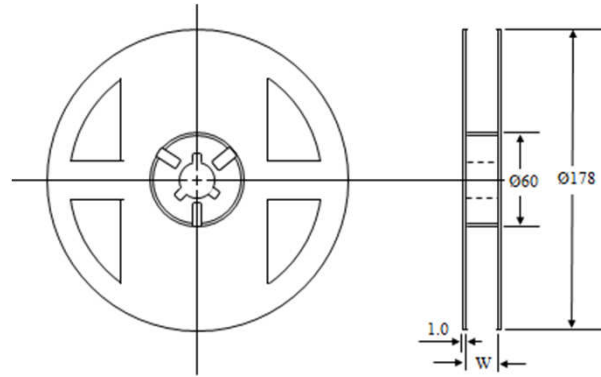

Type	Chip Cavity		Insert Pitch	Tape Thickness		
	A	B	F	K	T	W
SWI1008	2.20	2.83	4.00	1.75	0.22	8.00

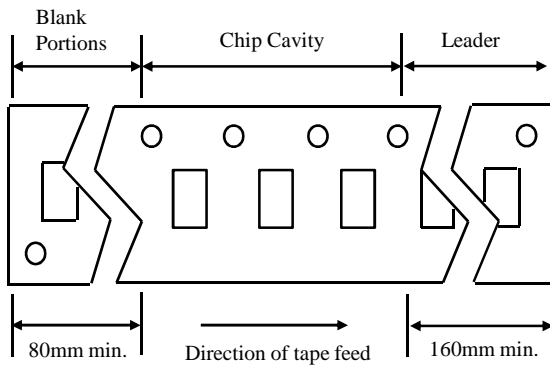
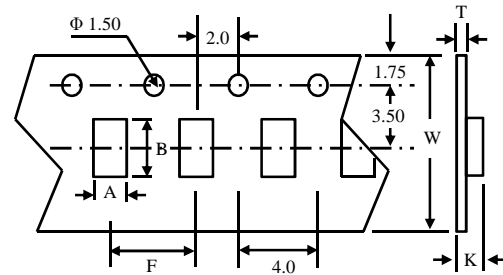

**Top Tape Strength**

The top tape requires a peel-off force of 0.2 to 0.7N in the direction of the arrow as illustrated below.

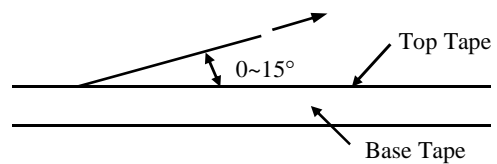

**Dimensions (unit : m/m)**

Type	A	B	C
SWI1008	3.00	1.20	2.20

**Recommended Pattern**

