

SPECIFICATION FOR APPROVAL

REF. :

PROD. NAME	Shielded SMD Power Inductor	ABC'S DWG NO.	SS1205□□□□T□-□□□		
		REV.	20160901-D	PAGE	1

I . Configuration and dimensions :

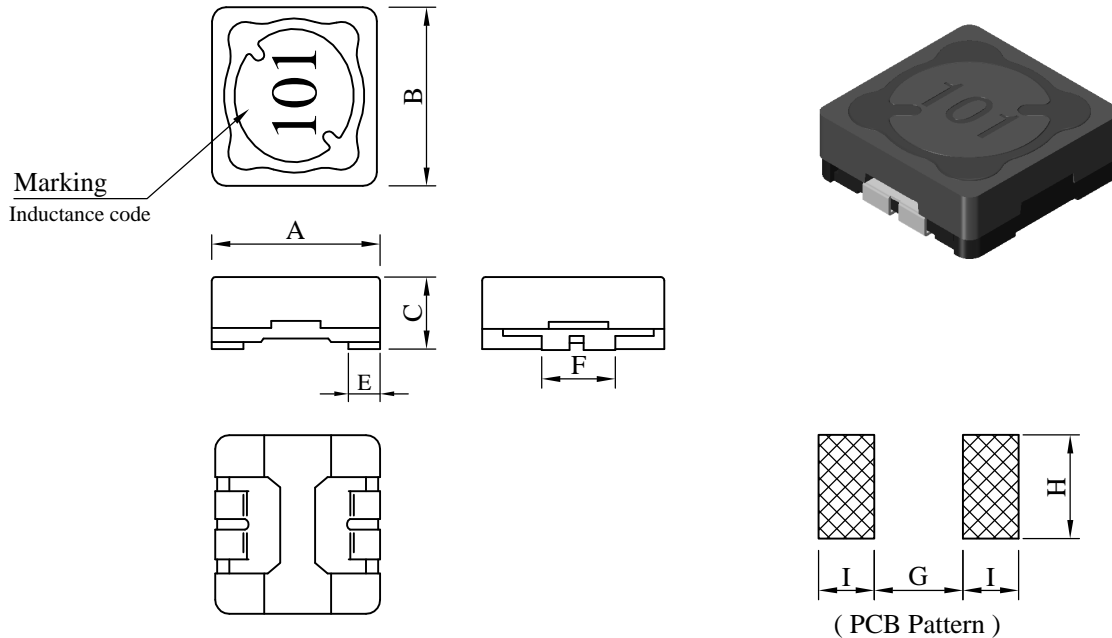

Unit : m/m

A	B	C	E	F	G	H	I
12.70 ±0.3	12.70 ±0.3	5.00 ±0.5	2.30 ±0.2	5.00 ±0.2	6.00 ref.	7.00 ref.	4.00 ref.

II . Description :

- a . Ferrite drum core construction.
- b . Magnetically shielded.
- c . Enamelled copper wire : H class
- d . Product weight : 2.53 g (ref.)
- e . Moisture sensitivity Level 1
- f . Products comply with RoHS' requirements
- g . Halogen free available

III . General specification :

- a . Storage temp. : -40°C ----+125°C
- b . Operating temp. : -40°C ----+125°C
(Temp. rise included)
- c . Resistance to solder heat : 245°C .10 secs.

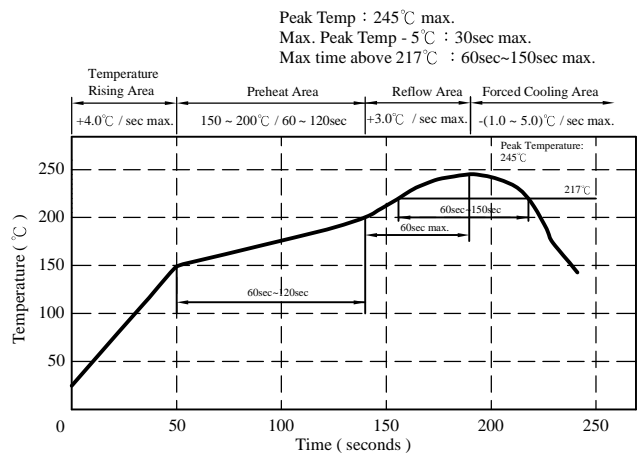

AR-001C

SPECIFICATION FOR APPROVAL

REF. :

PROD. NAME	Shielded SMD Power Inductor	ABC'S DWG NO.	SS1205□□□□T□-□□□		
		REV.	20160901-D	PAGE	2

IV . Electrical characteristics :

DWG No.	Inductance (μ H)	Test Freq. (Hz)	RDC ($m\Omega$) max.	IDC (A) max.
SS12052R5MT□-□□□	2.50±20%	1k	24.0	5.00
SS12055R0MT□-□□□	5.00±20%	1k	35.0	4.00
SS12057R5MT□-□□□	7.50±20%	1k	40.0	3.50
SS1205100MT□-□□□	10.00±20%	1k	54.0	3.00
SS1205120MT□-□□□	12.00±20%	1k	65.0	2.80
SS1205150MT□-□□□	15.00±20%	1k	70.0	2.70
SS1205180MT□-□□□	18.00±20%	1k	82.0	2.60
SS1205220MT□-□□□	22.00±20%	1k	95.0	2.40
SS1205250MT□-□□□	25.00±20%	1k	120.0	2.00
SS1205330MT□-□□□	33.00±20%	1k	145.0	1.80
SS1205390MT□-□□□	39.00±20%	1k	160.0	1.65
SS1205500YT□-□□□	50.00±15%	1k	200.0	1.50
SS1205560YT□-□□□	56.00±15%	1k	240.0	1.40
SS1205680YT□-□□□	68.00±15%	1k	280.0	1.30
SS1205750YT□-□□□	75.00±15%	1k	330.0	1.20
SS1205101KT□-□□□	100.00±10%	1k	400.0	1.00
SS1205121KT□-□□□	120.00±10%	1k	500.0	0.90
SS1205151KT□-□□□	150.00±10%	1k	580.0	0.80
SS1205181KT□-□□□	180.00±10%	1k	750.0	0.70
SS1205221KT□-□□□	220.00±10%	1k	840.0	0.65
SS1205271KT□-□□□	270.00±10%	1k	1000.0	0.60
SS1205331KT□-□□□	330.00±10%	1k	1340.0	0.54
SS1205391KT□-□□□	390.00±10%	1k	1500.0	0.50
SS1205471KT□-□□□	470.00±10%	1k	1980.0	0.45
SS1205561KT□-□□□	560.00±10%	1k	2200.0	0.40
SS1205681KT□-□□□	680.00±10%	1k	2400.0	0.35
SS1205821KT□-□□□	820.00±10%	1k	3000.0	0.30

- 1). □ : Packaging information : □ Code
- 2). "- □□□ " : Reference code
- 3). Electrical specifications at 25°C
- 4). IDC base on Temp. rise 40°C max.
& $\Delta L/L0A=10\%$ max.

AR-001C

SPECIFICATION FOR APPROVAL

REF. :

PROD. NAME	Shielded SMD Power Inductor	ABC'S DWG NO.	SS1205□□□□T□-□□□		
		REV.	20160901-D	PAGE	3

V . Curve :

SS12052R5MT□

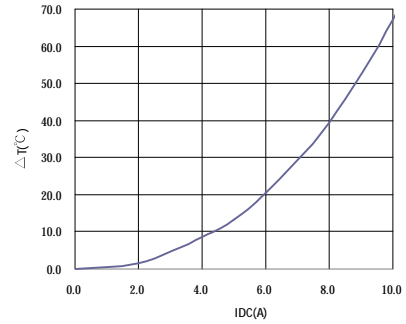
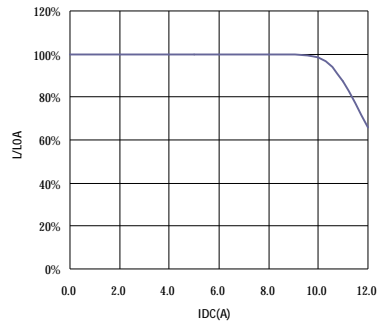

SS1205330MT□

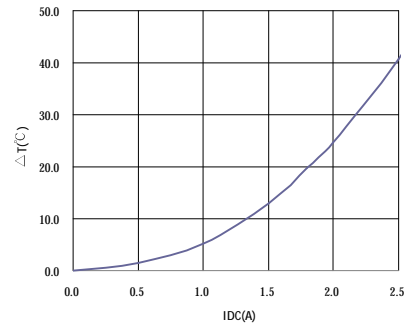
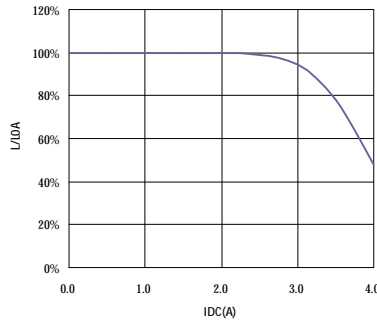

SS1205101KT□

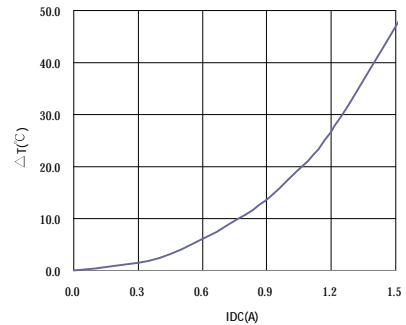
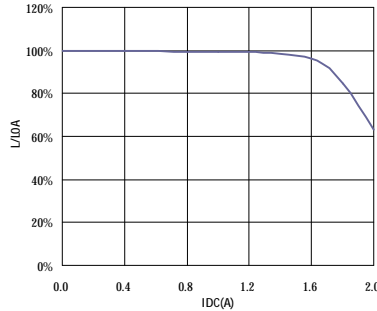

SS1205271KT□

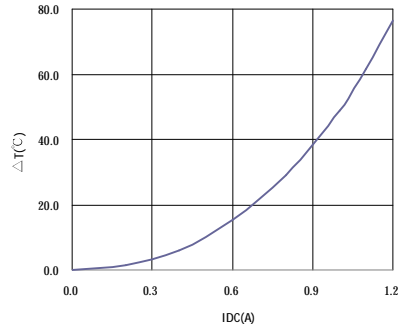
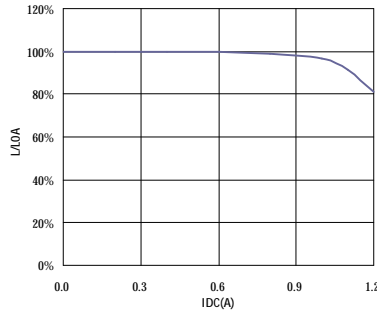

AR-001C

SPECIFICATION FOR APPROVAL

REF. :

PROD. NAME	Shielded SMD Power Inductor	ABC'S DWG NO.	SS1205□□□□T□-□□□		
		REV.	20160901-D	PAGE	4

VI . Packaging information :

(1) Configuration

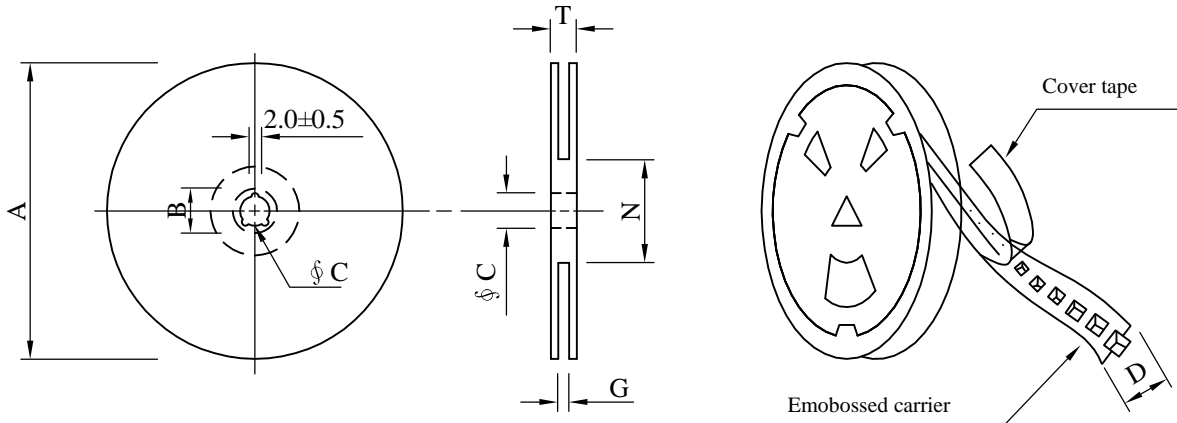

※Carrier tape width : D

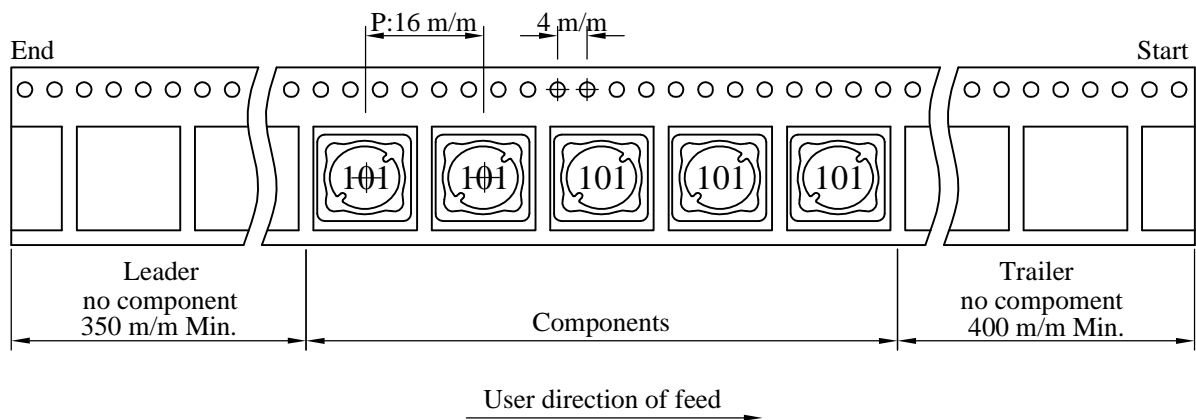

(2) Dimensions

Unit:m/m

Style	A	B	C	D	G	N	T
13 - 24	330	21±0.8	13±0.5	24	26 ⁺⁰	60 ⁻⁰	30.4

(3) Q'TY & G.W. Per package

Code	Inner : Reel			Outer : Carton		
	Q'TY (pcs)	G.W. (gw)	Style	Q'TY (pcs)	G.W. (Kg)	Size (cm)
B	600	1900	13 - 24	2,400	9.8	38 x 37 x 22

AR-001C

SPECIFICATION FOR APPROVAL

REF. :

PROD. NAME	Shielded SMD Power Inductor	ABC'S DWG NO.	SS1205□□□□T□-□□□		
		REV.	20160901-D	PAGE	5

VII . Drawing number expression :

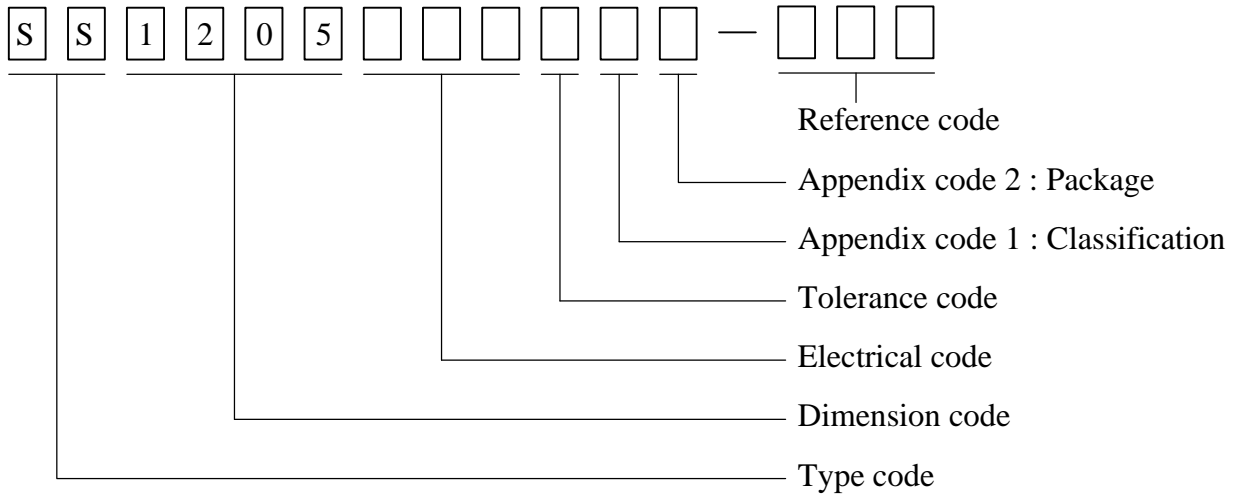

Appendix code 1 : Product Classification

Appendix code 2 : Package Information

Code	Inner package	Cover tape	Carrier tape	Bag	Package Q'TY	Remark
B	T/R (Reel package)	UCT	Antistatic	Antistatic	600 pcs	

AR-001C

SPECIFICATION FOR APPROVAL

REF. :

PROD. NAME	Shielded SMD Power Inductor	ABC'S DWG NO.	SS1205□□□□T□-□□□		
		REV.	20160901-D	PAGE	6

VIII . Reliability test :

Item	Reference documents	Test Condition	Test Specification
1.High Temperature Exposure	MIL-STD-202 Method 108	1.Temperature: 125±2℃ 2.Time:96±2 hours.	1.No mechanical or electrical damage. 2.Inductance shall not change more than ±20%.
2.Temperature Cycling	JESD22-A 104	1.Temperature: -40℃ ~ +125℃ 2.Number of cycle:100 cycles 3.Dwell time:30 minutes	1.No mechanical or electrical damage. 2.Inductance shall not change more than ±20%.
3.Biased Humidity Test	MIL-STD-202 Method 103	1.Temperature : 85±2℃ 2.Humidity: 85% RH. 3.Time:96±2 Hours	1.No mechanical or electrical damage. 2.Inductance shall not change more than ±20%.
4.Operational Life	JESD22-A 108	1.Temperature: 125℃ (Temp. rise included) 2.Time:96±2 hours. 3.Rated current	1.No mechanical or electrical damage. 2.Inductance shall not change more than ±20%.
5.External Visual	JESD22-B 101 & MIL-STD-883 Method 2009	Inspect product constructions, marking and workmanship.	1.No pollution on the surface of products. 2.Clear marking. 3.No crack.
6.Physical Dimensions	JESD22-B 100	Verify physical dimensions to the applicable product detail specification.	Per product specification standard
7.Resistance to solvents	MIL-STD-202 Method 215	Immerse into solvent for 3±0.5 minutes & brush 10 times for 3 cycles.	1.No body change in apperance. 2.No marking blurred. 3.Inductance shall not change more than ±20%.
8.Vibration Test	MIL-STD-202 Method 204	1.Frequency and Amplitud : 10-2000-10 Hz, 1.5 mm. 2.Direction:X, Y, Z 3.Test duration:2 hours for each direction, 6 hours in total.	1.No mechanical or electrical damage. 2.Inductance shall not change more than ±20%.
9.Resistance To Soldering Heat Test	MIL-STD-202 Method 210 & J-STD020D.1	1.Highest temperature : 245±5℃. 2.Time (temp. ≥ 217℃) : 60~150 Seconds. 3.IR reflow times : 3 times.	1.No mechanical or electrical damage. 2.Inductance shall not change more than ±20%.
10.Saturation Current	JIS C 6436 & User SPEC.	1.Applied rated current for 5 seconds. 2.Saturation current	Inductance shall not drop more than 10% max.
11.Over load	JIS C 6436 & User SPEC.	1.Applied one and half rated current for a period of 5 minutes. 2.Rated current	No electrical or mechanical damage
12.Temperature Rise Current	JIS C 6436 & User SPEC.	1.Applied rated current for 10 minutes. 2.Temperature measure by digital surface thermometer. 3.Irms current	Surface temperature rise is less than 40℃ max.
13.Solderability Test	J-STD-002 & JESD22-B 102	1.Baking in pre-testing : 150±5℃ / 16Hours±30 min. 2.Peak temperature : 240±5℃ 3.Time (temp. ≥ 217℃) : 60~150 seconds. 4.IR reflow times : 1 time.	More than 95% soldering coverage min on terminations.
14.Electrical Characteriazation	MIL-STD-202 Method 304 & User SPEC.	1.Operating temperature : -40℃~125℃ 2.Room temperature : 25℃.	1.No mechanical or electrical damage. 2.Inductance shall not change more than ±20%.
15.Drop	CNS-C6354 & GB/T 2423.8	1.Products shall be mounted on SPEC. PCB and dropped down from a height of 1m 2.Drop total time : 6 times (Every side of sample drop 2 times)	1. Adhesion on PCB shall be enough. 2. Product appearance shall not break. 3. No electrical damage.
16.Terminal Strength Test	IEC 60068-2-21	1.Apply push force to samples mounted on PCB. 2.Force of 1.8 kg for 60±1 seconds.	After test, inductors shall be no mechanical damage.

AR-001C