

SPECIFICATION FOR APPROVAL

REF. :

PROD. NAME	Shielded SMD Power Inductor	ABC'S DWG NO.	SH3009□□□□L□-□□□		
		REV.	20151102-D	PAGE	1

I . Configuration and dimensions :

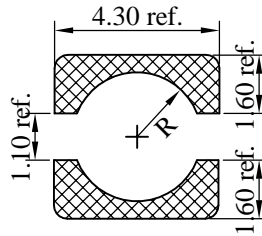
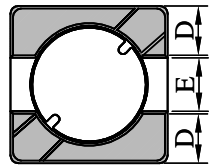
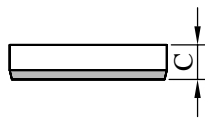
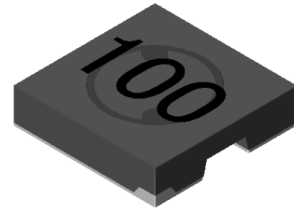
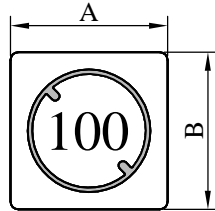

or

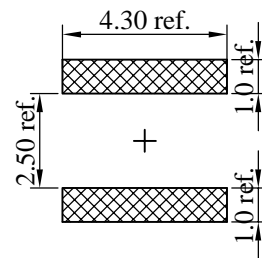

(PCB Pattern)

Unit : m/m

A	B	C	D	E	R
3.80 ±0.3	3.80 ±0.3	0.90 ±0.1	1.30 typ.	1.20 typ.	1.30 ref.

II . Description :

- a . Ferrite drum core construction.
- b . Magnetically shielded.
- c . Enamelled copper wire : H class
- d . Product weight : 0.05 g (ref.)
- e . Moisture sensitivity Level 1
- f . Products comply with RoHS' requirements
- g . Halogen free available

Peak Temp : 260°C max.
Max. Peak Temp - 5°C : 30sec max.
Max time above 217°C : 60sec~150sec max.

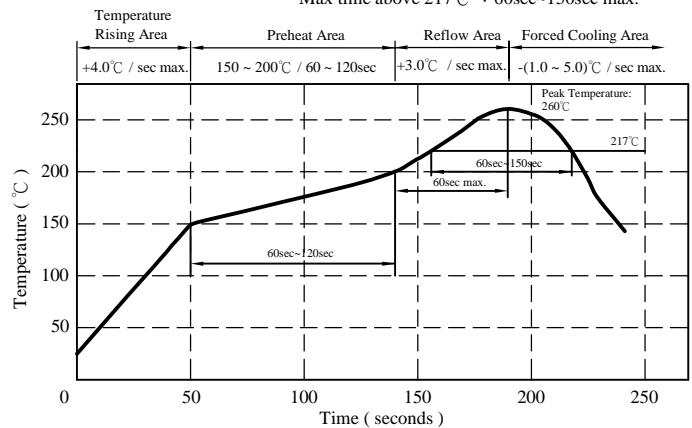

III . General specification :

- a . Storage temp. : -40°C ----+125°C
- b . Operating temp. : -40°C----+125°C
(Temp. rise included)
- c . Resistance to solder heat : 260°C.10 secs.

AR-001C

SPECIFICATION FOR APPROVAL

REF. :

PROD. NAME	Shielded SMD Power Inductor	ABC'S DWG NO.	SH3009□□□□L□-□□□		
		REV.	20151102-D	PAGE	2

IV . Electrical characteristics :

DWG No.	Inductance (μ H)	Q ref.	Test Freq. (MHz)	SRF (MHz) typ.	RDC (m Ω)		Irms (mA) typ.	Isat (mA) typ.
					typ.	max.		
SH30091R3YL□-□□□	1.3 \pm 30 %	8	7.96	145	82	110	1800	1600
SH30092R2YL□-□□□	2.2 \pm 30 %	10	7.96	90	121	160	1300	1200
SH30093R3YL□-□□□	3.3 \pm 30 %	8	7.96	80	175	230	1000	900
SH30094R7YL□-□□□	4.7 \pm 30 %	8	7.96	68	257	340	760	700
SH30096R8YL□-□□□	6.8 \pm 30 %	10	7.96	48	410	550	640	600
SH3009100YL□-□□□	10.0 \pm 30 %	12	2.52	44	666	900	600	550
SH3009150YL□-□□□	15.0 \pm 30 %	16	2.52	34	877	1180	420	400
SH3009220YL□-□□□	22.0 \pm 30 %	14	2.52	26	1230	1660	380	350

- 1). □: Packaging information : □ Code
- 2). "-□□□" : Reference code
- 3). Electrical specifications at 25°C
- 4). Inductance test freq. : 100kHz / 1V
- 5). Irms Base on temp rise 40°C typ.
- 6). Isat Base on Δ L/L0A=35% typ.

@ Inductance VS. DC Current Curve

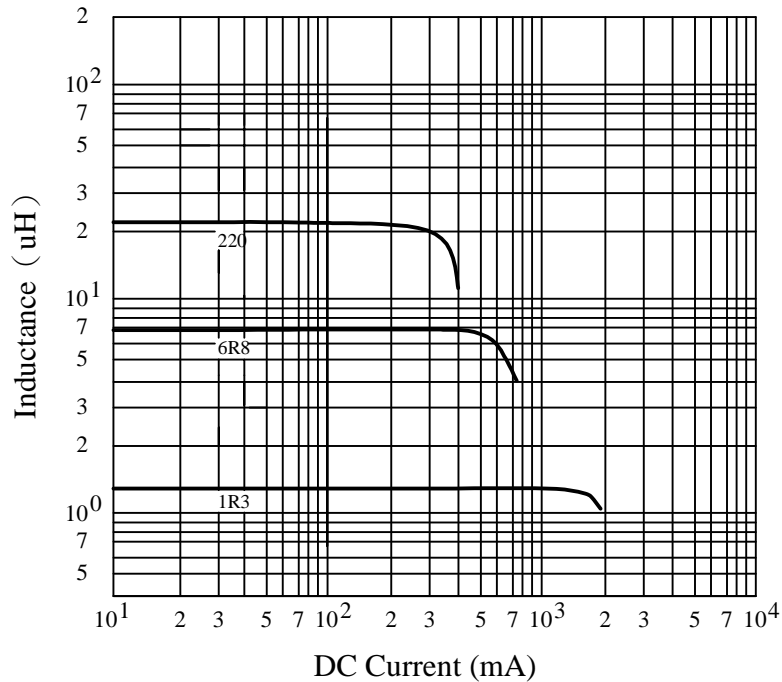

AR-001C

SPECIFICATION FOR APPROVAL

REF. :

PROD. NAME	Shielded SMD Power Inductor	ABC'S DWG NO.	SH3009□□□□L□-□□□		
		REV.	20151102-D	PAGE	3

V . Packaging information :

(1) Configuration

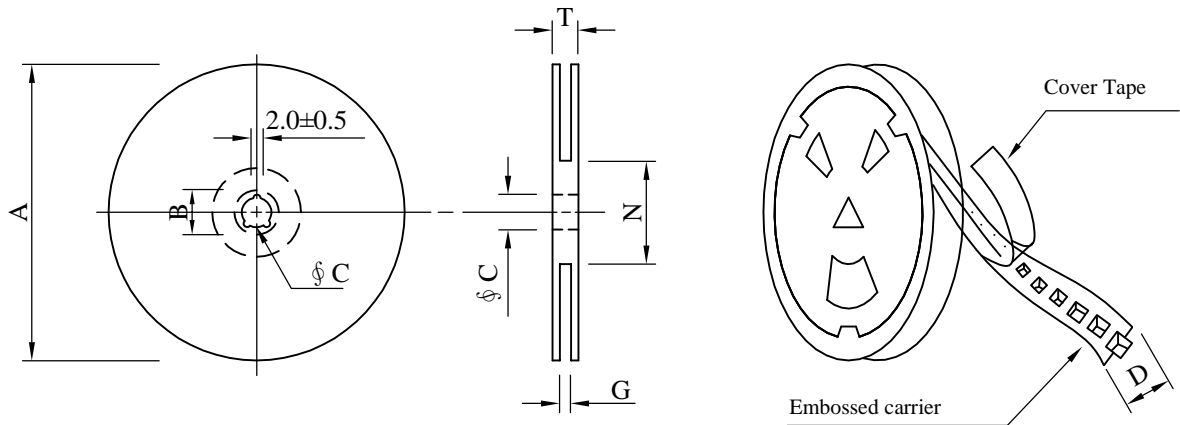

※Carrier tape width : D

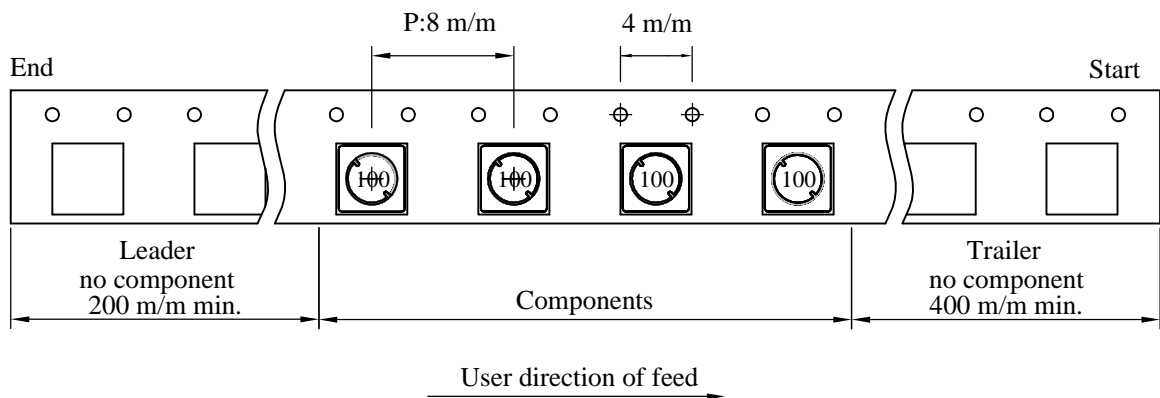

(2) Dimensions

Unit:m/m

Style	A	B	C	D	G	N	T
07 - 12	178	21±0.8	13	12	14 ⁺⁰	50 ⁻⁰	16.5

(3) Q'TY & G.W. Per package

Code	Inner : Reel			Outer : Carton		
	Q'TY (pcs)	G.W. (gw)	Style	Q'TY (pcs)	G.W. (Kg)	Size (cm)
B	1,500	200	07 - 12	60,000	9.5	42 x 41 x 24

AR-001C

SPECIFICATION FOR APPROVAL

REF. :

PROD. NAME	Shielded SMD Power Inductor	ABC'S DWG NO.	SH3009□□□□L□-□□□		
		REV.	20151102-D	PAGE	4

VI . Reliability test :

Item	Reference documents	Test Condition	Test Specification
1.High Temperature Exposure	MIL-STD-202 Method 108	1.Temperature: 125±2℃ 2.Time:96±2 hours.	1.No mechanical or electrical damage. 2.Inductance shall not change more than ±20%.
2.Temperature Cycling	JESD22-A 104	1.Temperature: -40℃ ~ +125℃ 2.Number of cycle:100 cycle 3.Dwell time:30 minutes	1.No mechanical or electrical damage. 2.Inductance shall not change more than ±20%.
3.Biased Humidity Test	MIL-STD-202 Method 103	1.Temperature : 85±2 ℃ 2.Humidity: 85% RH. 3.Time:96±2 Hours	1.No mechanical or electrical damage. 2.Inductance shall not change more than ±20%.
4.Operational Life	JESD22-A 108	1.Temperature: 125℃ (Temp. rise included) 2.Time:96±2 hours. 3.Rated current	1.No mechanical or electrical damage. 2.Inductance shall not change more than ±20%.
5.External Visual	JESD22-B 101 & MIL-STD-883 Method 2009	Inspect product constructions, marking and workmanship.	1.No pollution on the surface of products. 2.Clear marking. 3.No crack.
6.Physical Dimensions	JESD22-B 100	Verify physical dimensions to the applicable product detail specification.	Per product specification standard
7.Resistance to solvents	MIL-STD-202 Method 215	Immerse into solvent for 3±0.5 minutes & brush 10 times for 3 cycles.	1.No body change in apperaranec. 2.No marking blurred. 3.Inductance shall not change more than ±20%.
8.Vibration Test	MIL-STD-202 Method 204	1.Frequency and Amplitued : 10-2000-10 Hz, 1.5 mm. 2.Direction:X, Y, Z 3.Test duration:2 hours for each direction, 6 hours in total.	1.No mechanical or electrical damage. 2.Inductance shall not change more than ±20%.
9.Resistance To Soldering Heat Test	MIL-STD-202 Method 210 & J-STD020D.1	1.Highest temperature : 260±5℃. 2.Time (temp. ≥ 217℃) : 60~150 Second. 3.IR reflow times : 3 times.	1.No mechanical or electrical damage. 2.Inductance shall not change more than ±20%.
10.Saturation Current	JIS C 6436 & User SPEC.	1.Applied rated current for 5 second. 2.Saturation current	Inductance shall not drop more than 35% typ.
11.Over load	JIS C 6436 & User SPEC.	1.Applied one and half rated current for a period of 5 minutes. 2.Rated current	No electrical or mechanical damage
12.Temperature Rise Current	JIS C 6436 & User SPEC.	1.Applied rated current for 10 minutes. 2.Temperature measure by digital surface thermometer. 3.Irms current	Surface temperature rise is less than 40 ℃ typ.
13.Solderability Test	J-STD-002 & JESD22-B 102	1.Baking in pre-testing : 150±5℃ / 16Hours±30 min. 2.Peak temperature : 240±5℃ 3.Time (temp. ≥ 217℃) : 60~150 second. 4.IR reflow times : 1 times.	More than 95% soldering coverage min on terminations.
14.Electrical Characteriazation	MIL-STD-202 Method 304 & User SPEC.	1.Operating temperature : -40℃~125℃ 2.Room temperature : 25℃.	1.No mechanical or electrical damage. 2.Inductance shall not change more than ±20%.
15.Drop	CNS-C6354 & GB/T 2423.8	1.Products shall be mounted on SPEC. pcb and dropped down from a heigh of 1m 2.Drop total time : 6 time (Every side ofsample drop 2 time)	1. Adhesion on PCB shall be enough. 2. Product appearance shall not break. 3. No electrical damage.
16.Terminal Strength Test	IEC 60068-2-21	1.Apply push force to samples mounted on PCB. 2.Force of 1.8 kg for 60±1 seconds.	After test, inductors shall be no mechanical damage.

AR-001C