

# SPECIFICATION FOR APPROVAL

REF. :

PROD. NAME	Shielded SMD Power Inductor	ABC'S DWG NO.	SD1205□□□□1□-□□□		
		REV.	20130321-A	PAGE	1

## I . Configuration and dimensions :

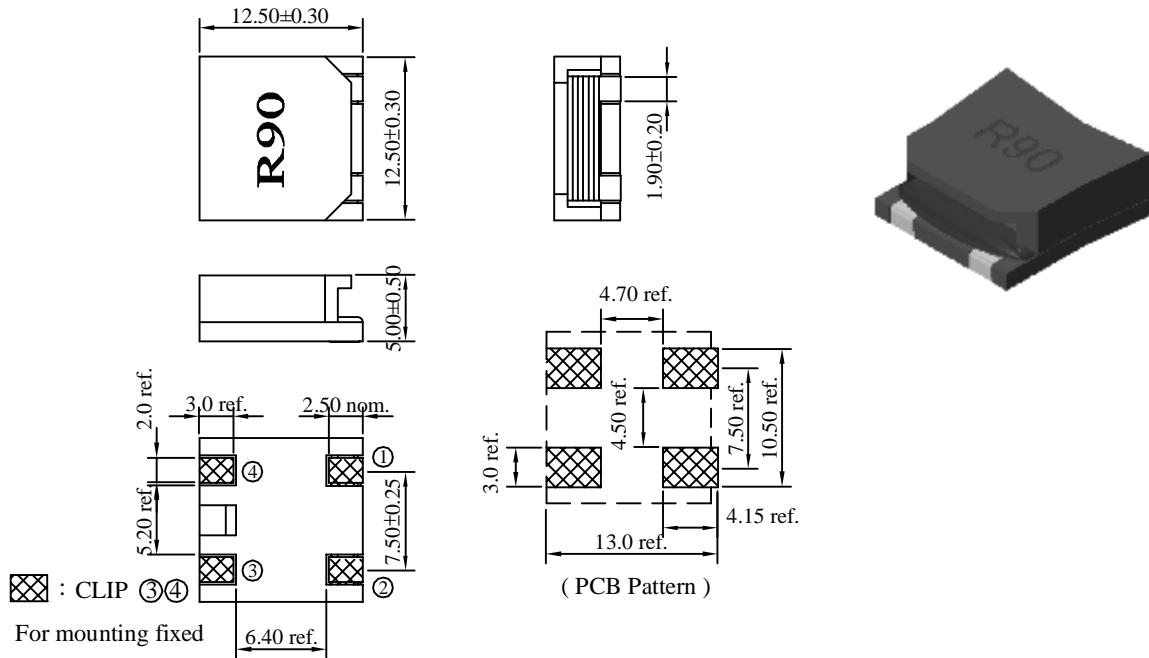

## II . Schematic diagram :

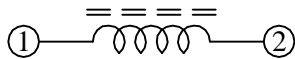

## III . Description :

- a . Ferrite drum core construction.
- b . Magnetically shielded.
- c . Enamelled copper wire : F class
- d . Product weight : 2.75 g ( ref. )
- e . Moisture sensitivity Level 1
- f . Products comply with RoHS' requirements
- g . Halogen free available

## IV . General specification :

- a . Storage temp. : -40°C ----+125°C
- b . Operating temp. : -40°C ----+125°C  
(Temp. rise included)
- c . Resistance to solder heat : 245°C .10 secs.

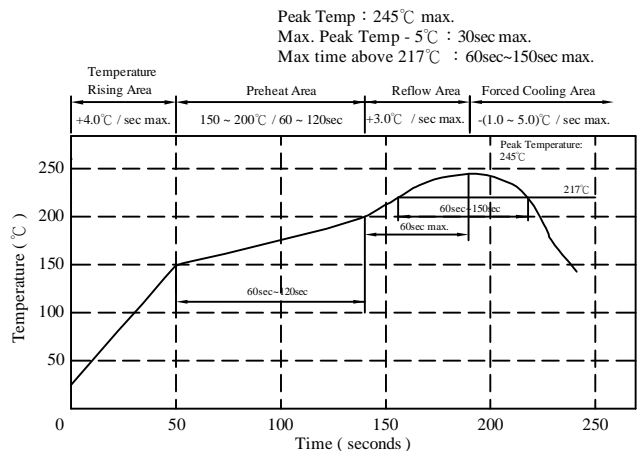

AR-001C

# SPECIFICATION FOR APPROVAL

REF. :

PROD. NAME	Shielded SMD Power Inductor	ABC'S DWG NO.	SD1205□□□□1□-□□□		
		REV.	20130321-A	PAGE	2

V . Electrical characteristics :

DWG No.	Initial inductance L0 ( uH )	Inductance at flat point L1 ( uH )	Flat point ref. ( A )	Irms ( A )	Isat ( A )	DC Resistance max. ( mΩ )
SD1205R90Y1□-□□□	0.90±25%	0.75±25%	5.0	18.0	20.0	2.5
SD12051R4Y1□-□□□	1.40±25%	1.25±25%	5.0	15.0	16.0	3.4
SD12052R0Y1□-□□□	2.00±25%	1.80±25%	4.0	12.0	13.0	4.6
SD12053R2Y1□-□□□	3.50±25%	3.20±25%	2.0	8.6	9.0	9.0
SD12054R6Y1□-□□□	4.80±25%	4.60±25%	2.0	8.2	7.2	10.5
SD12056R4Y1□-□□□	6.80±25%	6.40±25%	3.0	7.8	6.0	11.0
SD12058R2Y1□-□□□	8.60±25%	8.20±25%	3.0	7.2	5.4	12.0
SD1205100Y1□-□□□	10.50±25%	10.00±25%	2.0	6.5	4.7	13.5

- 1). □: Packaging information : □ Code
- 2). "- □□□" : Reference code
- 3). Electrical specifications at 25°C
- 4). Inductance Test Freq. : 100KHz / 1V
- 5). Irms base on Temp. rise 40°C max.
- 6). Isat base on inductance drop 20% max. of L1 value

AR-001C

# SPECIFICATION FOR APPROVAL

REF. :

PROD. NAME	Shielded SMD Power Inductor	ABC'S DWG NO.	SD1205□□□□1□-□□□		
		REV.	20130321-A	PAGE	3

@ Inductance VS. DC Superposition Characteristics

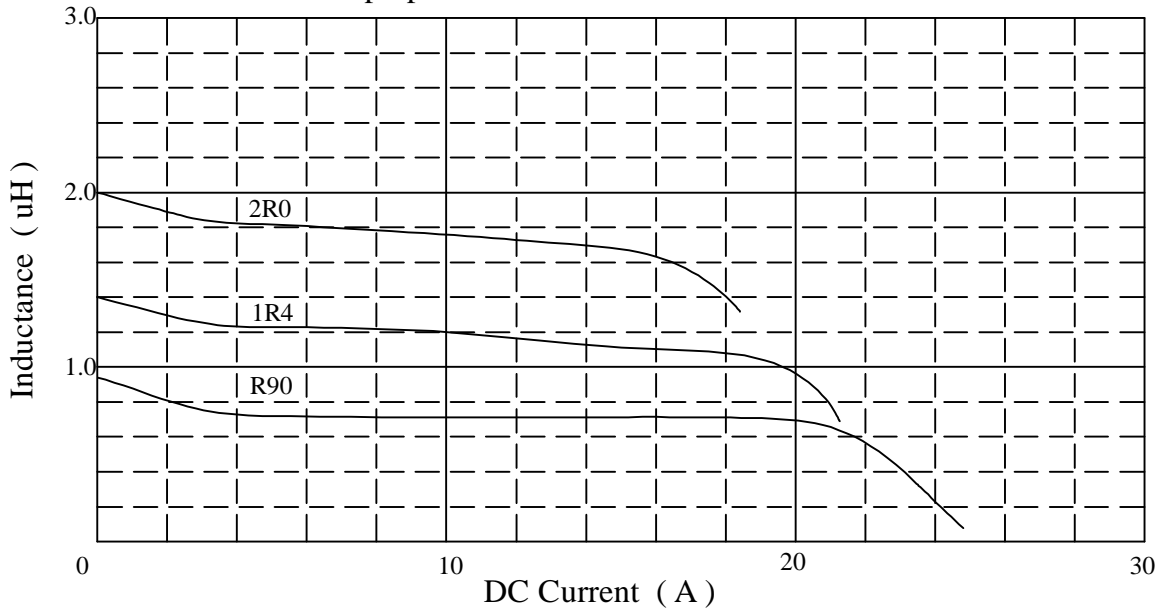

@ Inductance VS. DC Superposition Characteristics

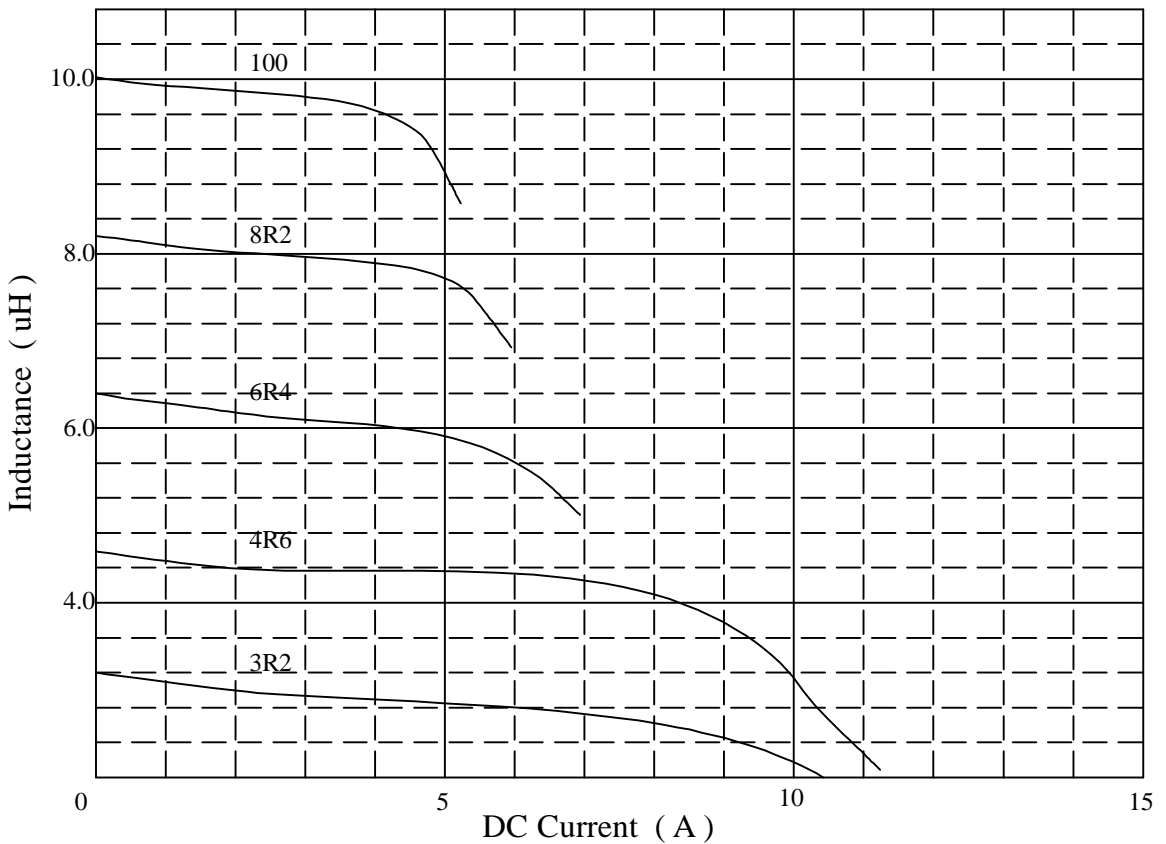

AR-001C

# SPECIFICATION FOR APPROVAL

REF. :

PROD. NAME	Shielded SMD Power Inductor	ABC'S DWG NO.	SD1205□□□□1□-□□□		
		REV.	20130321-A	PAGE	4

## VI . Packaging information :

### (1) Configuration

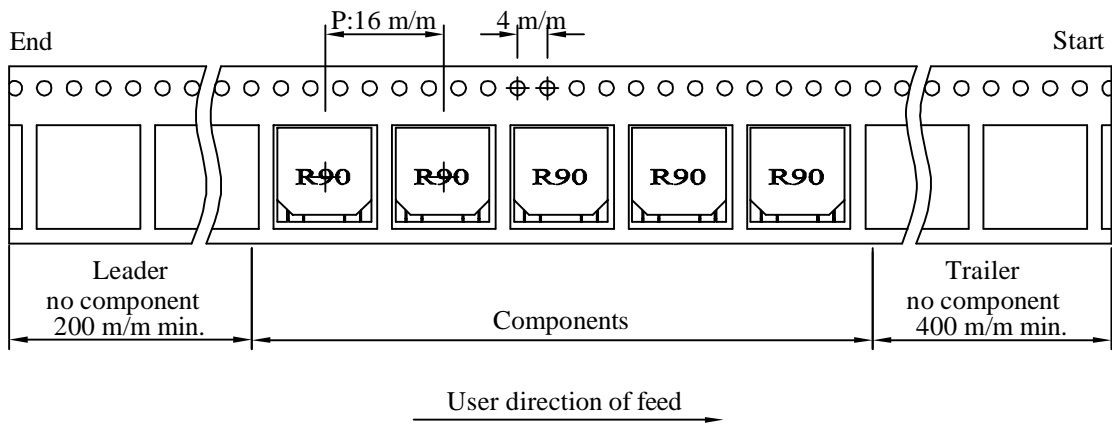
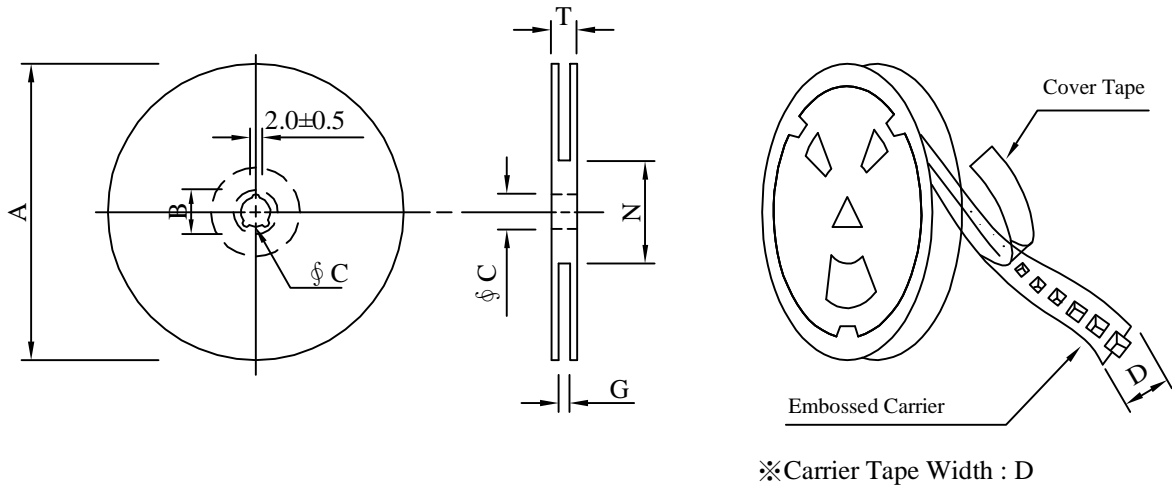

### (2) Dimensions

Unit:m/m

Style	A	B	C	D	G	N	T
13 - 24	330	21±0.8	13	24	26 <sup>+0</sup>	60 <sup>-0</sup>	30.4

### (3) Q'TY & G.W. Per package

Code	Inner : Reel			Outer : Carton		
	Q'TY (pcs)	G.W. (gw)	Style	Q'TY (pcs)	G.W. (Kg)	Size (cm)
B	600	2,150	13 - 24	2,400	11.30	38 x 37 x 22

AR-001C

# SPECIFICATION FOR APPROVAL

REF. :

PROD. NAME	Shielded SMD Power Inductor	ABC'S DWG NO.	SD1205□□□□1□-□□□		
		REV.	20130321-A	PAGE	5

## VII . Reliability test :

Item	Reference documents	Test Condition	Test Specification
1.High Temperature Exposure	MIL-STD-202 Method 108	1.Temperature: 125℃ 2.Time:96 hours.	1.No mechanical and electrical damage. 2.Inductance shall not change more than ±25%.
2.Temperature Cycling	JESD22 Method JA-104	1.Temperature: -40℃ ~ 125℃ 2.Number of cycle:96 cycle 3.Dwell time:30 minutes	1.No mechanical and electrical damage. 2.Inductance shall not change more than ±25%.
3.Biased Humidity Test	MIL-STD-202 Method 103	1.Temperature: 85±5℃ 2.Time:96 Hours 3.Humidity: 85±5% RH.	1.No mechanical and electrical damage. 2.Inductance shall not change more than ±25%.
4.Operational Life	MIL-PRF-27	1.Temperature: 125℃ 2.Time:96 hours. 3.Apply rated current.	1.No mechanical and electrical damage. 2.Inductance shall not change more than ±25%.
5.External Visual	MIL-STD-883 Method 2009	Inspect product constructions, marking and workmanship.	1.No pollution on the surface of products. 2.Clear marking. 3.No crack.
6.Physical Dimensions	JESD22 Method JB-100	Verify physical dimensions to the applicable product detail specification.	Per product specification standard
7.Resistance to solvents	MIL-STD-202 Method 215	Immerse into solvent for 3±0.5 minutes & brush 10 times for their cycles.	1.No body change in appearance. 2.No marking blurred. 3.Inductance shall not change more than ±25%.
8.Vibration Test	MIL-STD-202 Method 204	1.Frequency and Amplitued : 10-2000-10 Hz, 1.5 mm. 2.Direction:X, Y, Z 3.Test duration:2 hours for each direction, 6 hours in total.	1.No mechanical and electrical damage. 2.Inductance shall not change more than ±25%.
9.Resistance To Soldering Heat Test	MIL-STD-202 Method 210	1.Highest temperature : 245±5℃ 2.Time ( temp. ≥ 217℃ ) : 60~150 Second. 3.IR reflow times : 3 times.	1.No mechanical and electrical damage. 2.Inductance shall not change more than ±25%.
10.Rated current	MIL-STD-202 Method 330	Apply rated current for 5 second.	1.No mechanical and electrical damage. 2.Inductance shall not change more than ±25%.
11.Temperature rise	MIL-PRF-27	Apply rated current for 10 minutes.	1.No mechanical and electrical damage. 2.Inductance shall not change more than ±25%.
12.Over load	MIL-PRF-27	Apply twice as rated current for 5 minutes. (It's not application to some special design)	1.No mechanical and electrical damage. 2.Inductance shall not change more than ±25%.
13.Solderability Test	J-STD-002	1.Baking in pre-testing : 155±5℃ / 16Hours±30 min. 2.Peak temperature : 240±5℃ 3.Time ( temp. ≥ 217℃ ) : 60~150 second. 4.IR reflow times : 1 times.	The terminal shall be at least 95% covered with fresh solder.
14.Electrical Characteriazation	User Spec.	1.Operating temperature : -40℃~125℃ 2.Room temperature : 25℃.	1.No mechanical and electrical damage. 2.Inductance shall not change more than ±25%.
15.Withstanding Voltage Test	MIL-STD-202 Method 201	1.DV:500V 2.Time:1minutes	1.During the test no breakdown. 2.The characteristic is normal after test.
16.Drop	JESD22-B111	Packaged & Drop down from 1m.In 1 angle 1ridges & 2 surfaces orientation.	1.No case deformation or change in appearance. 2.Inductance shall not change more than ±25%.
17.Terminal Strength Test	JIS-C-6429	1.Apply push force to samples mounted on PCB. 2.Force of 1.8 kg for 60±1 seconds.	After test, inductors shall be no mechanical damage.

AR-001C