

LOW DROPOUT VOLTAGE REGULATOR

■ GENERAL DESCRIPTION

The NJM2885 is low dropout voltage regulator designed for portable application.

Advanced Bipolar technology achieves low noise, high ripple rejection and low quiescent current.

■ PACKAGE OUTLINE

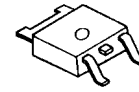

NJM2885DL1

■ FEATURES

- High Ripple Rejection 75dB typ. (f=1kHz,Vo=3V Version)
- Output Noise Voltage Vno=45μVrms typ.
- Output capacitor with 2.2μF ceramic capacitor (Vo≥2.7V)
- Output Current Io(max.)=500mA
- High Precision Output Vo±1.0%
- Low Dropout Voltage 0.18V typ. (Io=300mA)
- Internal Short Circuit Current Limit
- Internal Thermal Overload Protection
- Bipolar Technology
- Package Outline TO-252-3

■ PIN CONFIGURATION

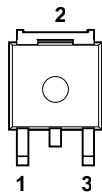

PIN FUNCTION

- 1. V_{IN}
- 2. GND
- 3. V_{OUT}

NJM2885DL1

■ BLOCK DIAGRAM

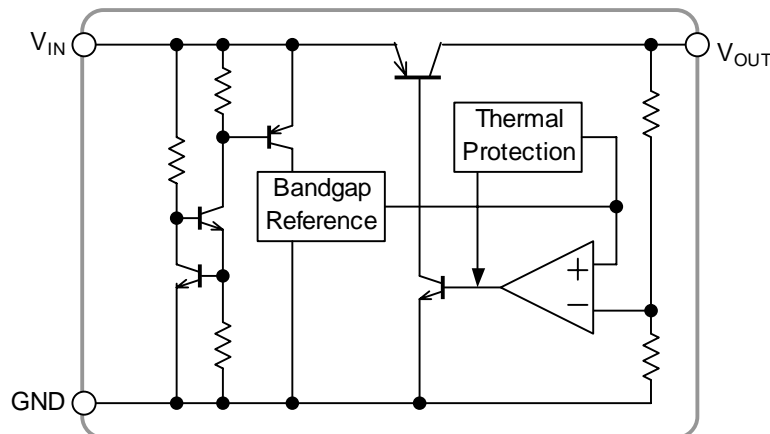

■ OUTPUT VOLTAGE RANK LIST

Device Name	V _{OUT}	Device Name	V _{OUT}
NJM2885DL1-15	1.5V	NJM2885DL1-28	2.8V
NJM2885DL1-18	1.8V	NJM2885DL1-03	3.0V
NJM2885DL1-19	1.9V	NJM2885DL1-33	3.3V
NJM2885DL1-21	2.1V	NJM2885DL1-35	3.5V
NJM2885DL1-25	2.5V	NJM2885DL1-38	3.8V
NJM2885DL1-26	2.6V	NJM2885DL1-05	5.0V

■ ABSOLUTE MAXIMUM RATINGS (Ta=25°C)

PARAMETER	SYMBOL	RATINGS	UNIT
Input Voltage	V _{IN}	+14	V
Power Dissipation	P _D	1190(*1) 3125(*2)	mW
Operating Temperature	T _{opr}	-40 ~ +85	°C
Storage Temperature	T _{stg}	-40 ~ +150	°C

(*1): Mounted on glass epoxy board. (76.2 × 114.3 × 1.6mm:based on EIA/JDEC standard size, 2Layers, Cu area 100mm²)

(*2): Mounted on glass epoxy board. (76.2 × 114.3 × 1.6mm:based on EIA/JDEC standard, 4Layers)

(For 4Layers: Applying 74.2 × 74.2mm inner Cu area and a thermal via hole to a board based on JEDEC standard JESD51-5)

■ Operating Voltage

V_{IN}=+2.3V ~ +14.0V (In case of V_o<2.1V)

■ ELECTRICAL CHARACTERISTICS

(V_{IN}=V_o+1V, C_{IN}=0.33μF, C_o=2.2μF, (1.7V<V_o≤2.6V: C_o=4.7μF, V_o≤1.7V:C_o=10μF), Ta=25°C)

PARAMETER	SYMBOL	TEST CONDITION	MIN.	TYP.	MAX.	UNIT
Output Voltage	V _o	I _o =30mA	-1.0%	-	+1.0%	V
Quiescent Current	I _Q	I _o =0mA	-	200	300	μA
Output Current	I _o	V _o -0.3V	500	650	-	mA
Line Regulation	ΔV _o /ΔV _{IN}	V _{IN} =V _o +1V ~ V _o +6.0V, I _o =30mA	-	-	0.10	%/V
Load Regulation	ΔV _o /ΔI _o	I _o =0 ~ 500mA	-	-	0.03	%/mA
Dropout Voltage(*3)	ΔV _{I-O}	I _o =300mA	-	0.18	0.28	V
Ripple Rejection	RR	e _{in} =200mVrms, f=1kHz, I _o =10mA V _o =3.0V Version	-	75	-	dB
Average Temperature Coefficient of Output Voltage	ΔV _o /ΔTa	Ta=0~85°C, I _o =10mA	-	±50	-	ppm/°C
Output Noise Voltage	V _{NO}	f=10Hz~80kHz, I _o =10mA, V _o =3.0V Version	-	45	-	μVrms

(*3): The output voltage excludes under 2.1V.

The above specification is a common specification for all output voltages.

Therefore, it may be different from the individual specification for a specific output voltage.

■ TEST CIRCUIT

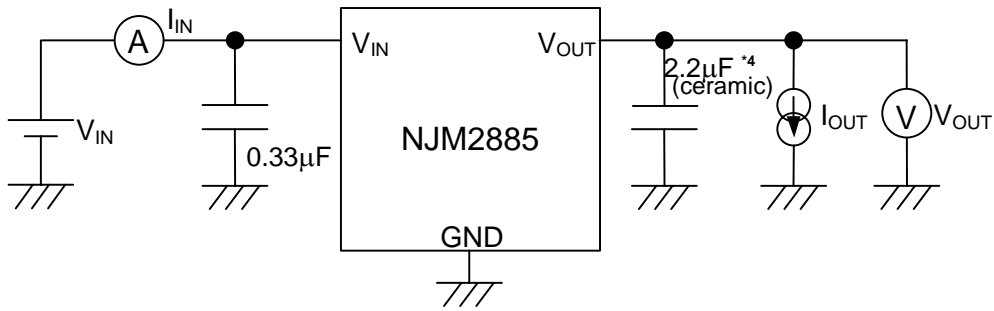

*4 1.7V < V_o ≤ 2.6V version: C_o = 4.7µF (ceramic)
 V_o ≤ 1.7V version: 10µF (ceramic)

■ POWER DISSIPATION VS. AMBIENT TEMPERATURE

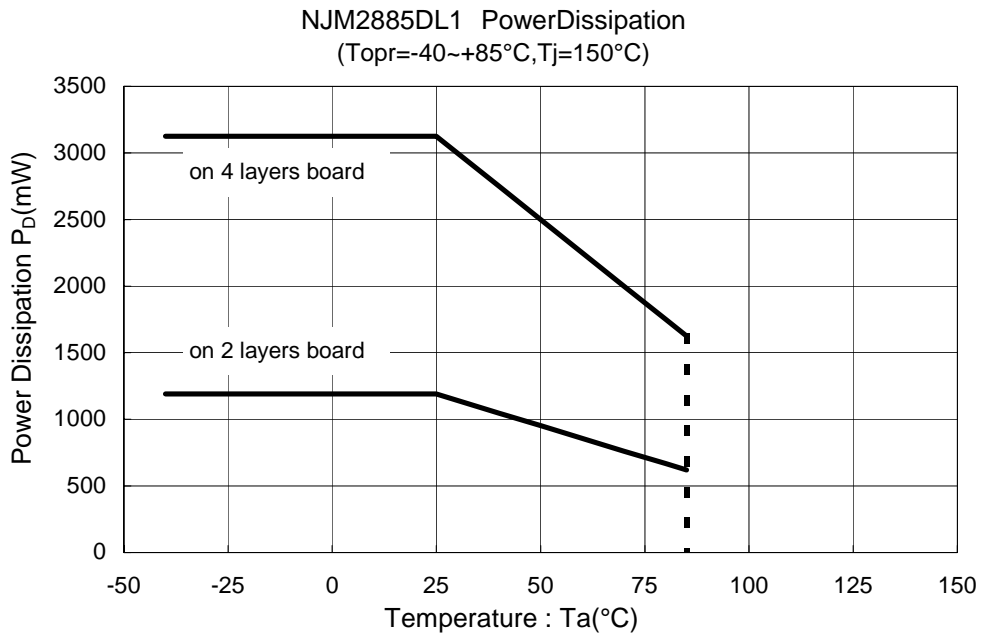

***Input Capacitor C_{IN}**

Input Capacitor C_{IN} is required to prevent oscillation and reduce power supply ripple for applications when high power supply impedance or a long power supply line.

Therefore, use the recommended C_{IN} value (refer to conditions of ELECTRIC CHARACTERISTIC) or larger and should connect between GND and V_{IN} as shortest path as possible to avoid the problem.

***Output Capacitor C_O**

Output capacitor (C_O) will be required for a phase compensation of the internal error amplifier.

The capacitance and the equivalent series resistance (ESR) influence to stable operation of the regulator.

Use of a smaller C_O may cause excess output noise or oscillation of the regulator due to lack of the phase compensation.

On the other hand, Use of a larger C_O reduces output noise and ripple output, and also improves output transient response when rapid load change.

Therefore, use the recommended C_O value (refer to conditions of ELECTRIC CHARACTERISTIC) or larger and should connect between GND and V_{OUT} as shortest path as possible for stable operation

The recommended capacitance depends on the output voltage rank. Especially, low voltage regulator requires larger C_O value.

In addition, you should consider varied characteristics of capacitor (a frequency characteristic, a temperature characteristic, a DC bias characteristic and so on) and unevenness peculiar to a capacitor supplier enough.

When selecting C_O , recommend that have withstand voltage margin against output voltage and superior temperature characteristic though this product is designed stability works with wide range ESR of capacitor including low ESR products.

ELECTRICAL CHARACTERISTICS

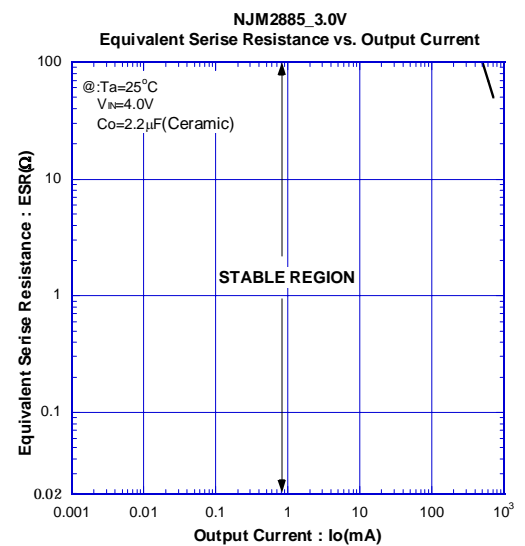
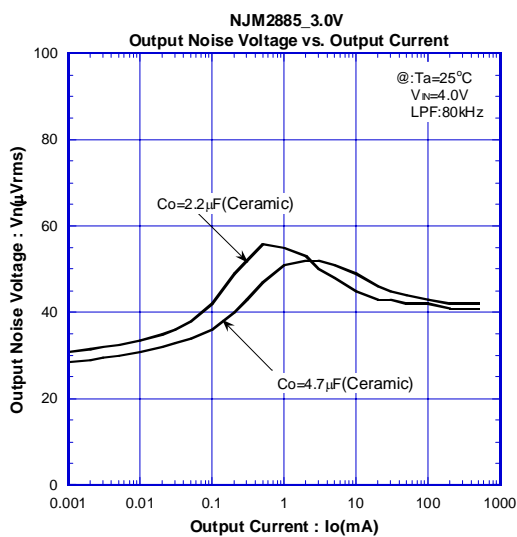
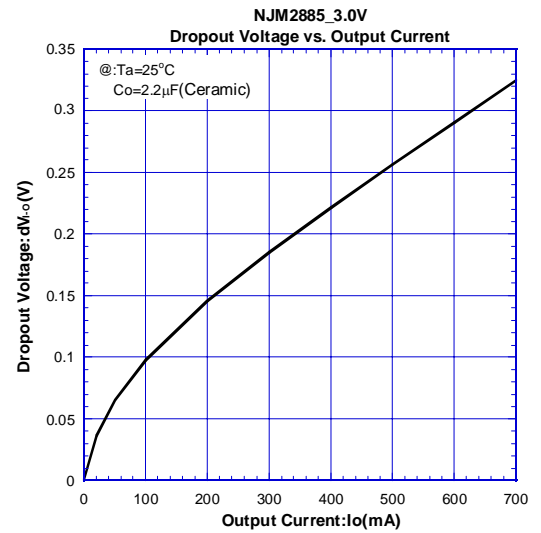
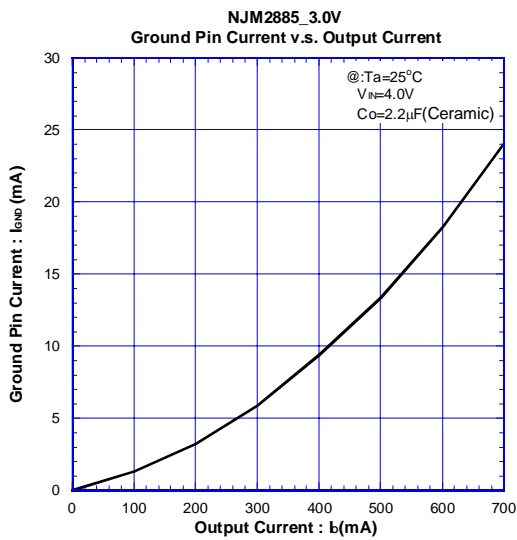
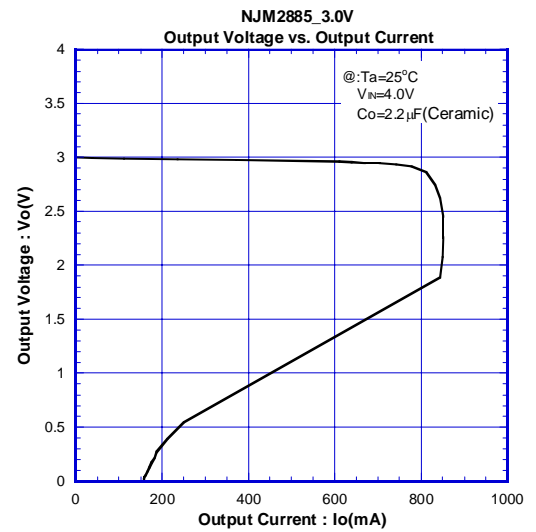
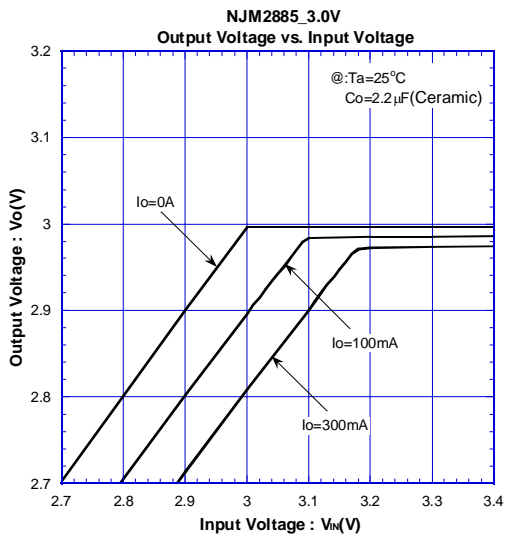

■ ELECTRICAL CHARACTERISTICS

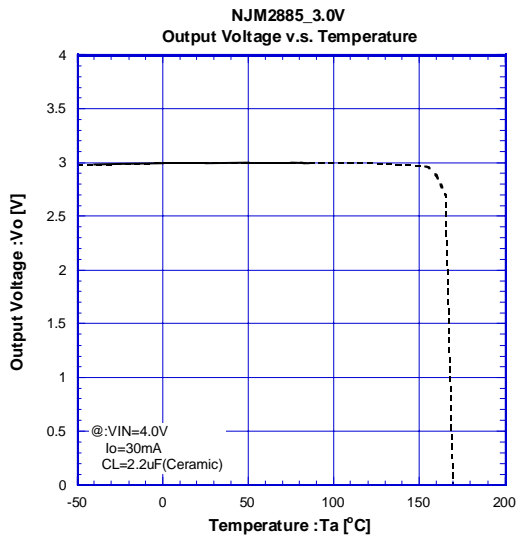
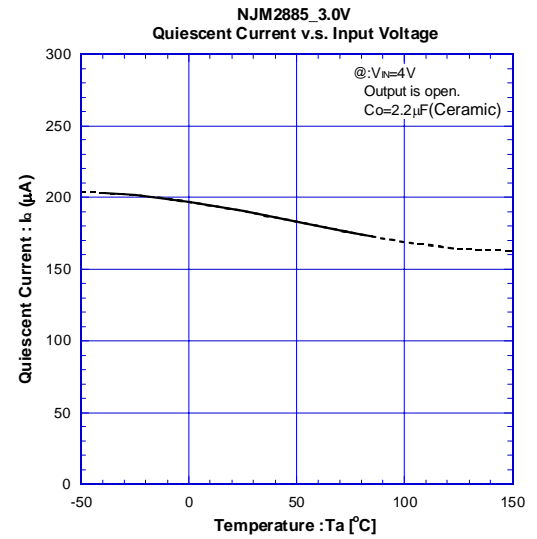
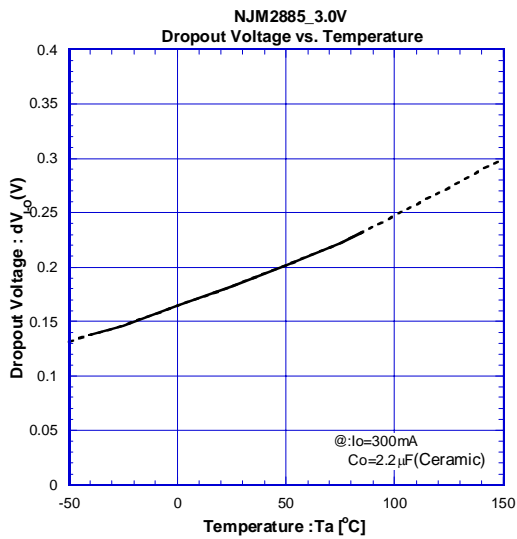
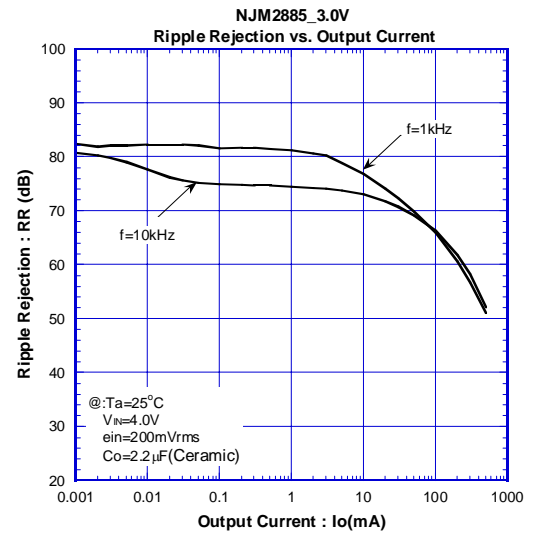
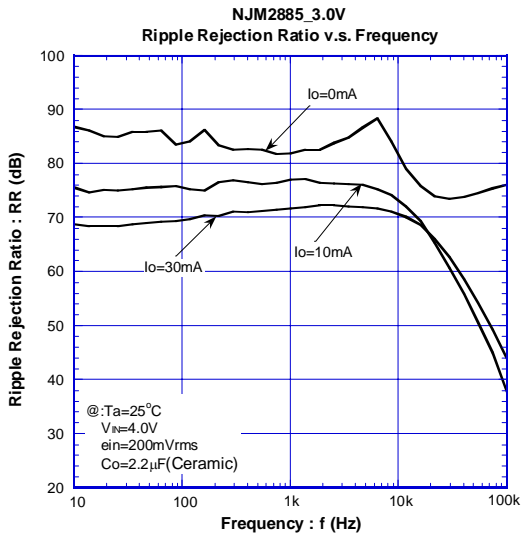

■ ELECTRICAL CHARACTERISTICS

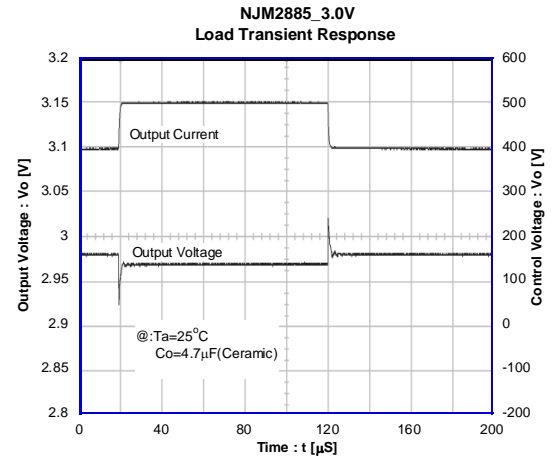
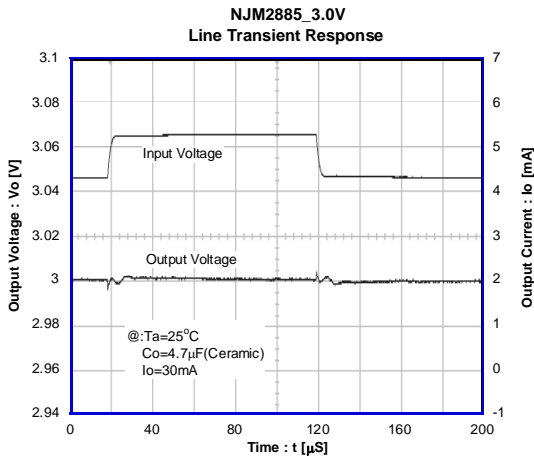

[CAUTION]
The specifications on this databook are only given for information, without any guarantee as regards either mistakes or omissions. The application circuits in this databook are described only to show representative usages of the product and not intended for the guarantee or permission of any right including the industrial rights.