

LDO with Reverse Current Protection / Discharge Function

FEATURES

- AEC-Q100 Grade 1 Qualified
- Operating Voltage Range 2.3V to 6.5V
- Output Voltage Accuracy $V_O \pm 2.0\%$
- Output Current $I_O(\text{min.})=200\text{mA}$
- Reverse Current Protection
- Discharge Function
- ON/OFF Control
- Correspond to Low ESR capacitor (MLCC)
- Thermal Shutdown Circuit
- Over Current Protection Circuit
- Package Outline SOT-23-5

APPLICATION

- Automotive infotainment
- Automotive ECU unit
- Industrial equipment

GENERAL DESCRIPTION

The NJM2879 is a low dropout regulator which achieves high ripple rejection, low noise and high speed response with the bipolar technology.

Small packaging and 0.47 μF decoupling capacitor make the NJM2879 suitable for space conscious applications. Moreover, the NJM2879 is not required noise reduction capacitor.

In addition, the reverse current protection makes external SBD unnecessary.

PIN CONFIGURATION

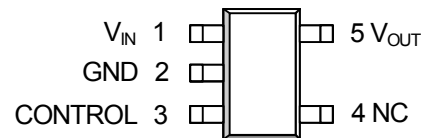

PIN NO.	SYMBOL	DESCRIPTION
1	V_{IN}	Input
2	GND	Ground
3	CONTROL	ON/OFF Control
4	NC	No Connection*
5	V_{OUT}	Output

Note) NC pin is not connect to internally circuit. This pin can be open or connected to ground. Connecting to ground is recommended to improve thermal dissipation.

TYPICAL APPLICATION

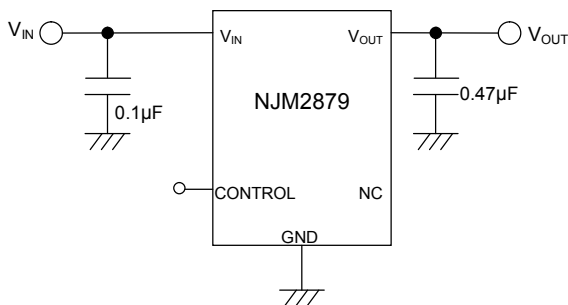

BLOCK DIAGRAM

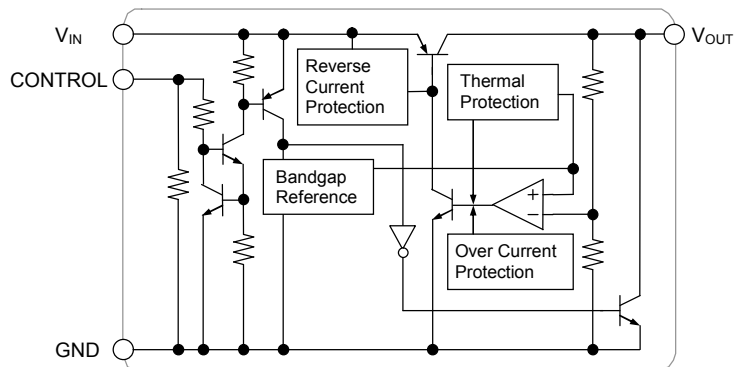

■OUTPUT VOLTAGE RANK

SOT-23-5

PART NUMBER	OUTPUT VOLTAGE	PART NUMBER	OUTPUT VOLTAGE
NJM2879F15-H	1.5V	NJM2879F33-H	3.3V
NJM2879F18-H	1.8V	NJM2879F05-H	5.0V
NJM2879F25-H	2.5V		

■PIN CONFIGURATION

SOT-23-5

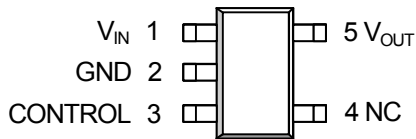

PIN NO.	SYMBOL	DESCRIPTION
1	V_{IN}	Input
2	GND	Ground
3	CONTROL	ON/OFF Control
4	NC	No Connection*
5	V_{OUT}	Output

Note) NC pin is not connect to internally circuit. This pin can be open or connected to ground. Connecting to ground is recommended to improve thermal dissipation.

■PRODUCT NAME INFORMATION

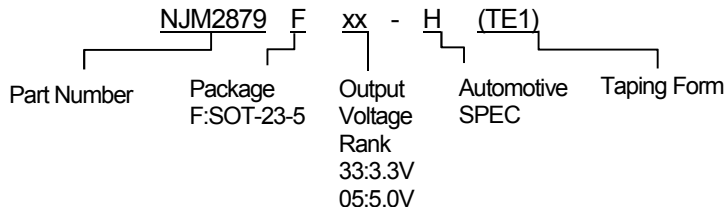

■ORDERING INFORMATION

PART NUMBER	OUTPUT VOLTAGE	PACKAGE OUTLINE	RoHS	HALOGEN-FREE	TERMINAL FINISH	MARKING	WEIGHT (mg)	MOQ(pcs)
NJM2879F33-H(TE1)	3.3V	SOT-23-5	yes	yes	Sn2Bi	AU1	15	3000

Note) "-" is non-evaluation. Please contact your sales representative for more information.

■ABSOLUTE MAXIMUM RATINGS

PARAMETER	SYMBOL	RATINGS		UNIT
Input Voltage	V_{IN}	-0.3 to +7		V
Control Pin Voltage	V_{CONT}	-0.3 to +7		V
Output Voltage	V_{OUT}	$V_o \leq 1.8V$	-0.3 to +5.5	V
		$V_o > 1.8V$	-0.3 to +7	V
Power Dissipation($T_a=25^\circ C$) SOT-23-5	P_D	(2-layer / 4-layer) 480 ⁽¹⁾ / 650 ⁽²⁾		mW
Junction Temperature Range	T_j	-40 to +150		$^\circ C$
Operating Temperature Range	T_{opr}	-40 to +125		$^\circ C$
Storage Temperature Range	T_{stg}	-50 to +150		$^\circ C$

(1): Mounted on glass epoxy board. (76.2×114.3×1.6mm: based on EIA/JEDEC standard, 2Layers)

(2): Mounted on glass epoxy board. (76.2×114.3×1.6mm: based on EIA/JEDEC standard, 4Layers), internal Cu area: 74.2×74.2mm

■RECOMMENDED OPERATING CONDITIONS

PARAMETER	SYMBOL	RATINGS	UNIT
Operating Voltage Range	V_{IN}	2.3 to 6.5	V
Control Voltage	V_{CONT}	0 to 6.5	V

■ ELECTRICAL CHARACTERISTICS

(Unless other noted, $V_{IN} = V_O + 1V$, $C_{IN} = 0.1\mu F$, $C_O = 0.47\mu F$ ($C_O = 1.0\mu F : 1.8V < V_O \leq 2.6V$, $C_O = 2.2\mu F : V_O \leq 1.8V$), $T_a = 25^\circ C$)

PARAMETER	SYMBOL	TEST CONDITION		MIN.	TYP.	MAX.	UNIT
Output Voltage	V_O	$I_O = 30mA$		-1.0%	-	+1.0%	V
		$I_O = 30mA$, $T_a = -40$ to $+125^\circ C$		-2.0%	-	+2.0%	
Quiescent Current	I_Q	$I_O = 0mA$, except I_{CONT}		-	150	200	μA
		$I_O = 0mA$, except I_{CONT} , $T_a = -40$ to $+125^\circ C$		-	-	250	
Quiescent Current at OFF-state	$I_{Q(OFF)}$	$V_{CONT} = 0V$		-	-	10	μA
		$V_{CONT} = 0V$, $T_a = -40$ to $+125^\circ C$		-	-	20	
Output Current	I_O	$V_O \times 0.9$		200	-	-	mA
		$V_O \times 0.9$, $T_a = -40$ to $+125^\circ C$		200	-	-	
Line Regulation	$\Delta V_O / \Delta V_{IN}$	$V_{IN} = V_O + 1V$ to $6.5V$, $I_O = 30mA$	$V_O = 3.3V$	-	-	7.3	mV
		$V_{IN} = V_O + 1V$ to $6.5V$, $I_O = 30mA$, $T_a = -40$ to $+125^\circ C$	$V_O = 3.3V$	-	-	15	
Load Regulation	$\Delta V_O / \Delta I_O$	$I_O = 0mA$ to $200mA$	$V_O = 3.3V$	-	-	50	mV
		$I_O = 0mA$ to $200mA$, $T_a = -40$ to $+125^\circ C$	$V_O = 3.3V$	-	-	119	
Dropout Voltage ⁽³⁾	ΔV_{IO}	$I_O = 100mA$		-	0.12	0.20	V
		$I_O = 100mA$, $T_a = -40$ to $+125^\circ C$		-	-	0.37	
Average Temperature Coefficient of Output Voltage	$\Delta V_O / \Delta T_a$	$T_a = -40$ to $+125^\circ C$, $I_O = 30mA$		-	± 50	-	ppm/ $^\circ C$
Ripple Rejection	RR	$e_{in} = 200mV_{rms}$, $f = 1kHz$, $I_O = 10mA$	$V_O = 3.3V$	-	66	-	dB
Output Noise Voltage	V_{NO}	$f = 10Hz$ to $80kHz$, $I_O = 10mA$	$V_O = 3.3V$	-	48	-	μV_{rms}
Control Current	I_{CONT}	$V_{CONT} = 1.6V$		-	3	12	μA
		$V_{CONT} = 1.8V$, $T_a = -40$ to $+125^\circ C$		-	-	20	
Control Voltage at ON-state	$V_{CONT(ON)}$			1.6	-	-	V
		$T_a = -40$ to $+125^\circ C$		1.8	-	-	
Control Voltage at OFF-state	$V_{CONT(OFF)}$			-	-	0.6	V
		$T_a = -40$ to $+125^\circ C$		-	-	0.5	
Discharge Current at OFF-state	I_{DIS}	$V_{IN} = 2.3V$, $V_{CONT} = 0V$, $V_O = 0.5V$		2	9	-	mA
		$V_{IN} = 6.5V$, $V_{CONT} = 0V$, $V_O = 0.5V$		15	25	-	

(3): Except Output Voltage Rank less than 2.1V

The above specifications are common specifications for all output voltages. Therefore, it may be different from the individual specification for a specific output voltage.

■ THERMAL CHARACTERISTICS

PARAMETER	SYMBOL	VALUE	UNIT
Junction-to-ambient thermal resistance	θ_{ja}	SOT-23-5 260 ⁽⁴⁾ 192 ⁽⁵⁾	$^{\circ}\text{C}/\text{W}$
Junction-to-Top of package characterization parameter	ψ_{jt}	SOT-23-5 70 ⁽⁴⁾ 60 ⁽⁵⁾	$^{\circ}\text{C}/\text{W}$

(4): Mounted on glass epoxy board. (76.2×114.3×1.6mm: based on EIA/JEDEC standard, 2Layers)

(5): Mounted on glass epoxy board. (76.2×114.3×1.6mm: based on EIA/JEDEC standard, 4Layers), internal Cu area: 74.2x74.2mm

■ POWER DISSIPATION vs. AMBIENT TEMPERATURE

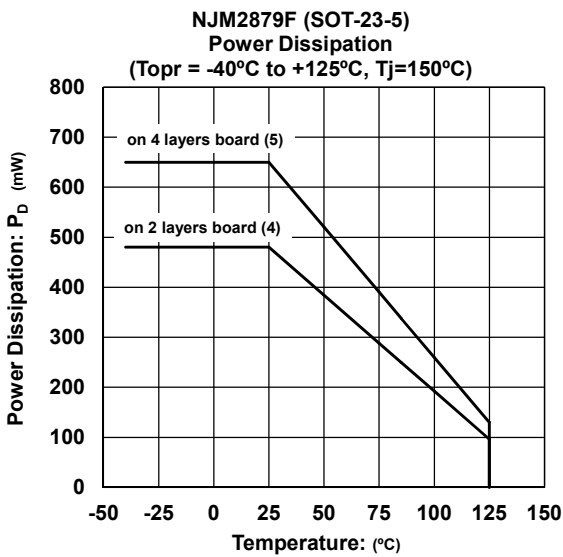

*Input Capacitor C_{IN}

The input capacitor C_{IN} is required in order to prevent oscillation and reduce power supply ripple of applications when high power supply impedance or a long power supply line.

Therefore, the recommended capacitance (refer to conditions of ELECTRIC CHARACTERISTIC) or larger input capacitor, connected between V_{IN} and GND as short path as possible, is recommended in order to avoid the problem.

*Output Capacitor C_O

The output capacitor C_O is required for a phase compensation of the internal error amplifier, and the capacitance and the equivalent series resistance (ESR) influence stable operation of the regulator.

If use a smaller output capacitor than the recommended capacitance (refer to conditions of ELECTRIC CHARACTERISTIC), it may cause excess output noise or oscillation of the regulator due to lack of the phase compensation. Therefore, the recommended capacitance or larger output capacitor, connected between V_{OUT} and GND as short path as possible, is recommended for stable operation. The recommended capacitance may be different by output voltage, therefore confirm the recommended capacitance of the required output voltage.

Furthermore, a larger output capacitor reduces output noise and ripple output, and also improves Output Transient Response when a load changes rapidly.

Selecting the output capacitor, should consider varied characteristics of a capacitor: frequency characteristics, temperature characteristics, DC bias characteristics and so on. Therefore, the capacitor that has a sufficient margin of the rated voltage against the output voltage and superior temperature characteristics, is recommended for C_O .

■ TYPICAL CHARACTERISTICS

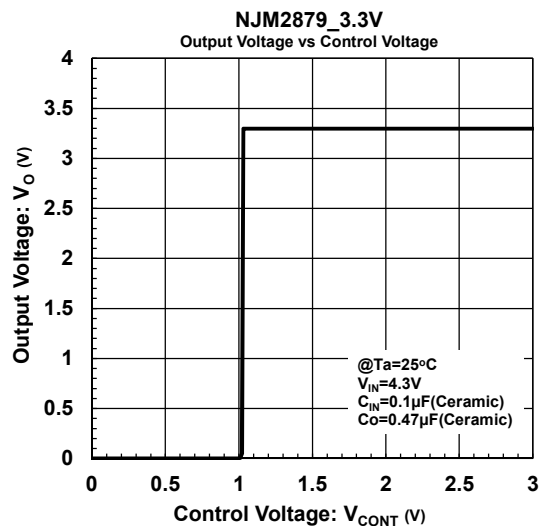
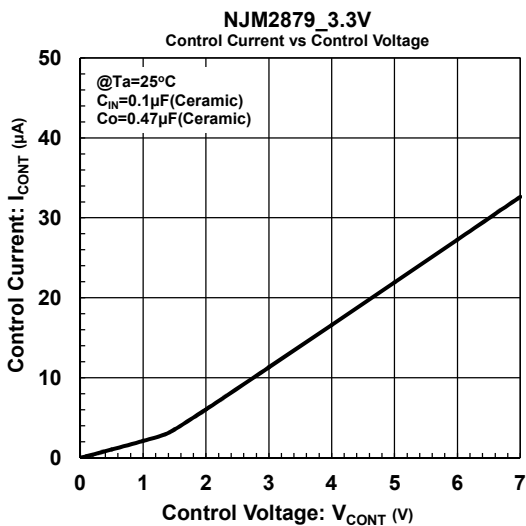
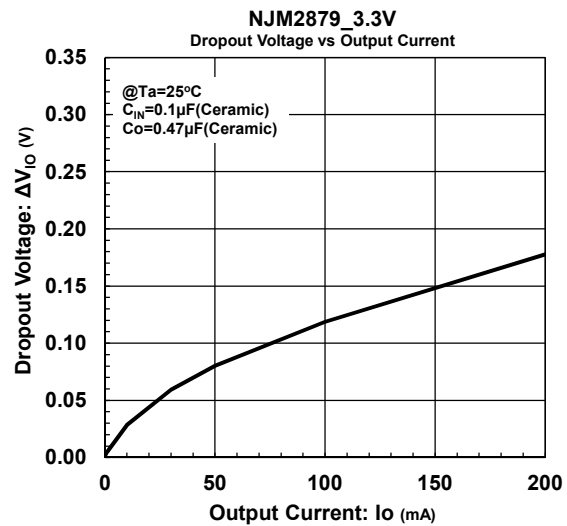
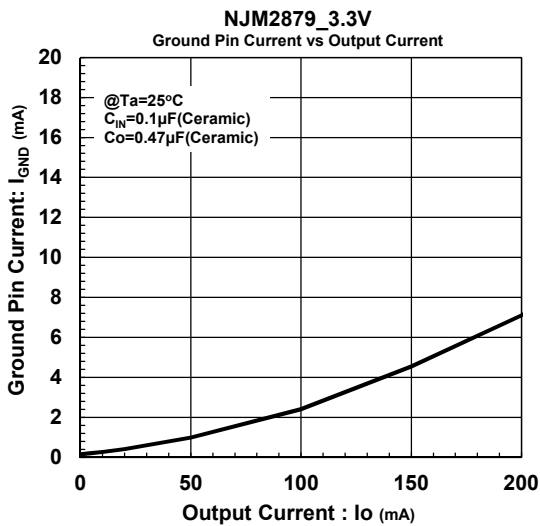
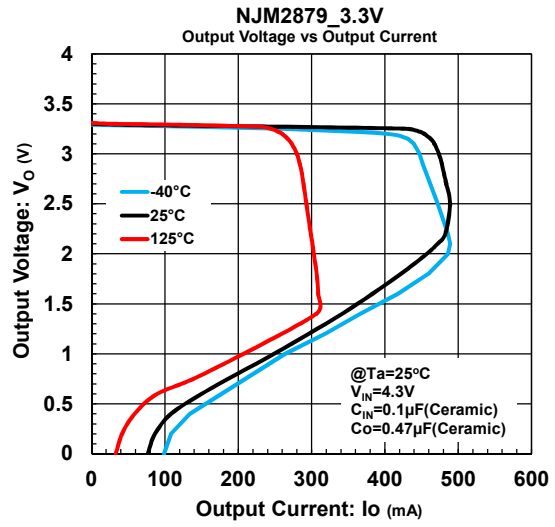
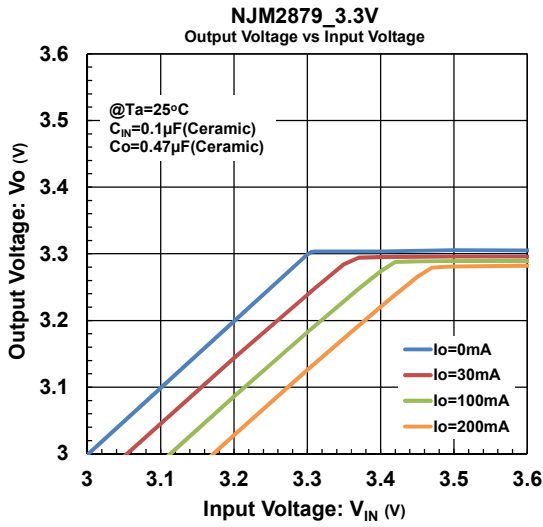

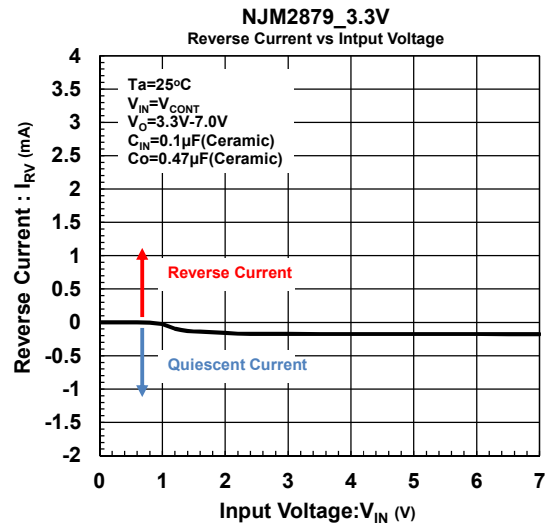
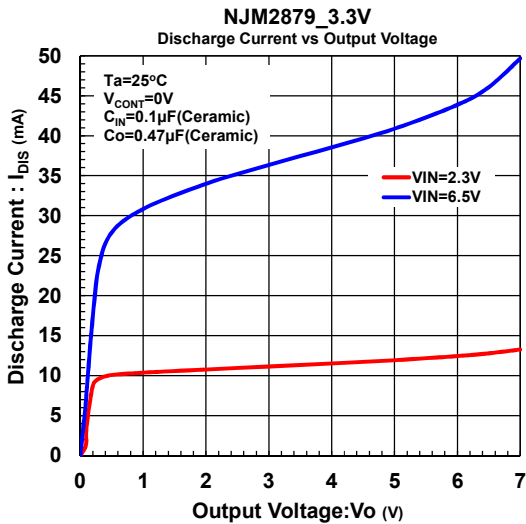
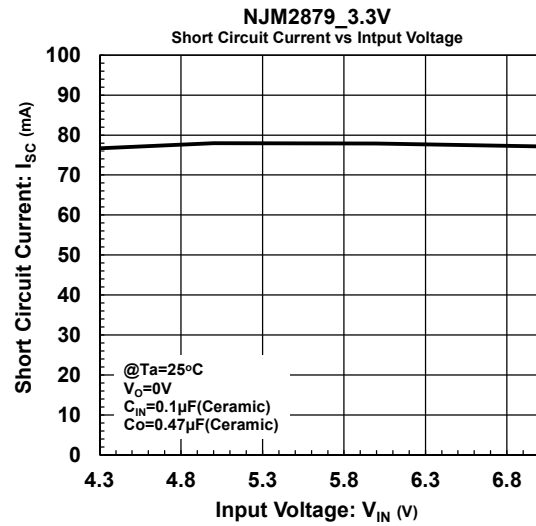
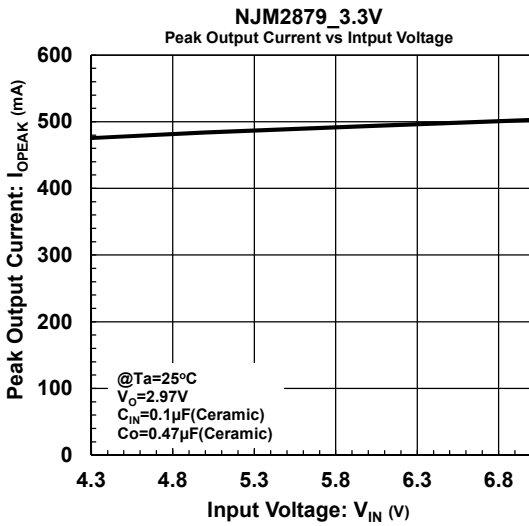
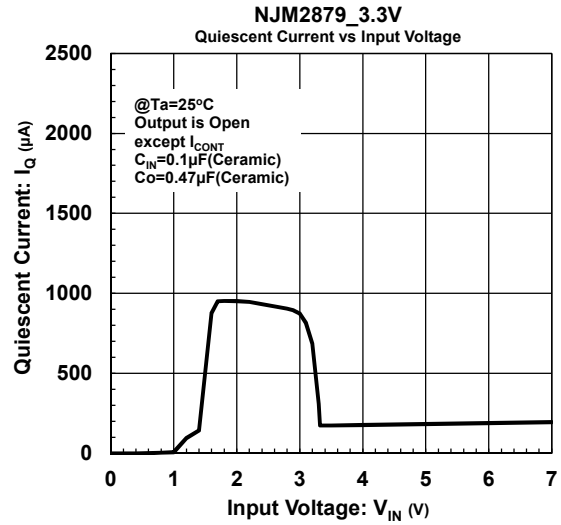
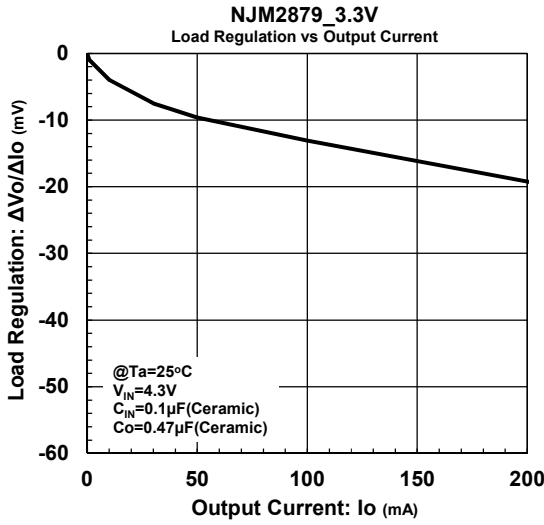

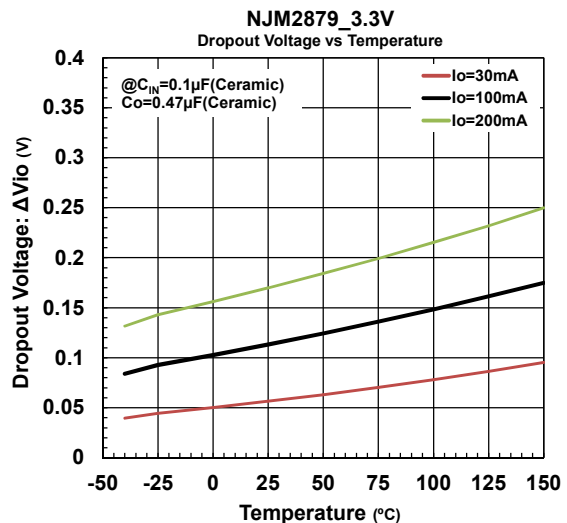
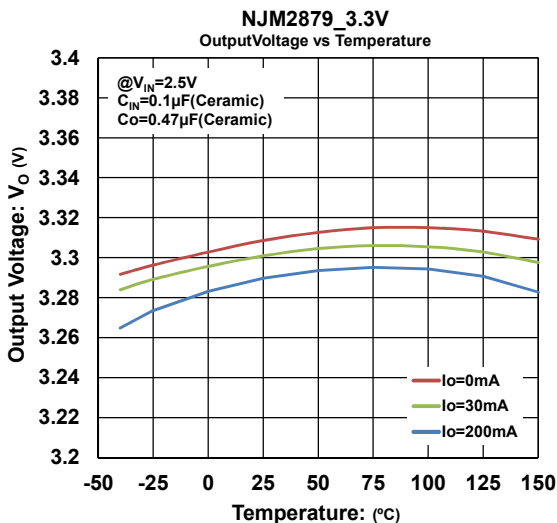
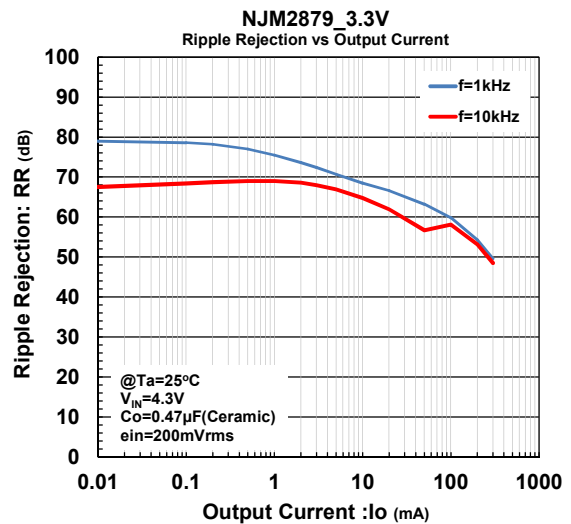
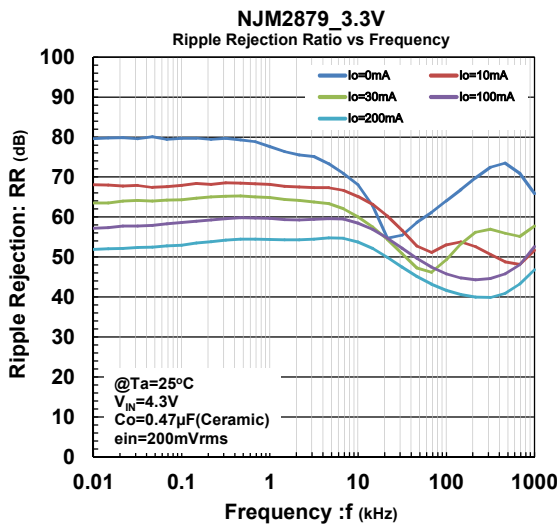
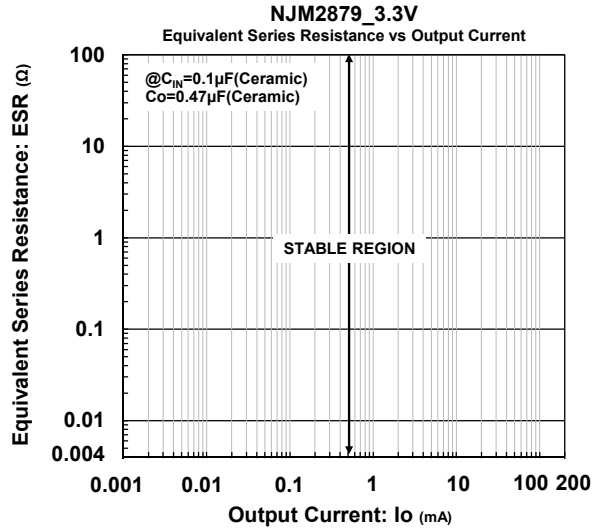
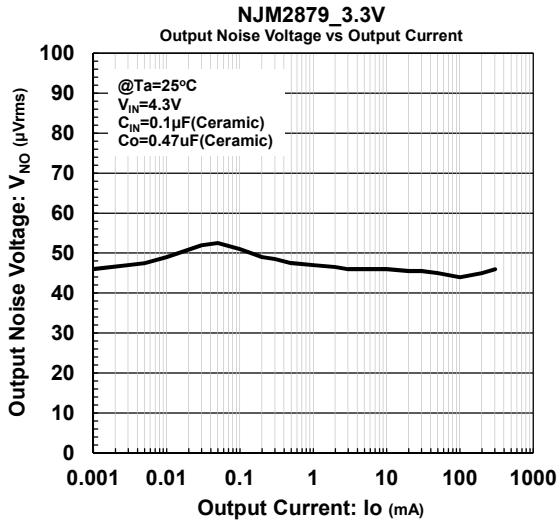

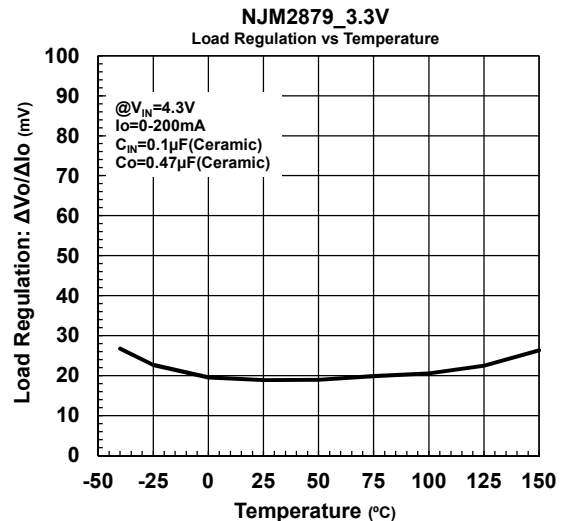
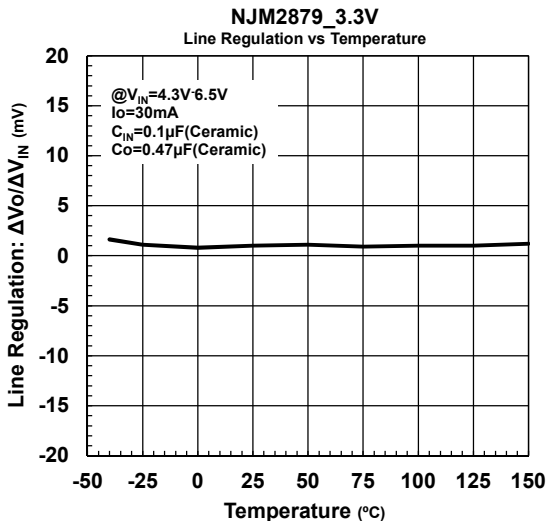
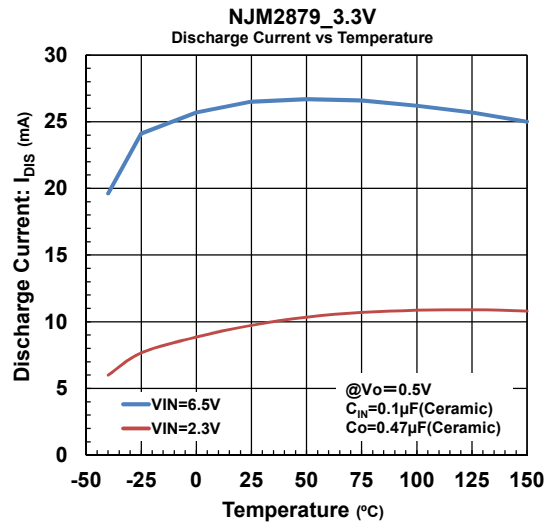
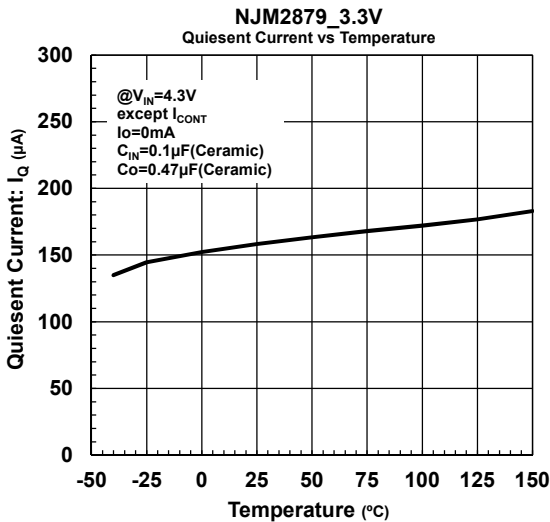
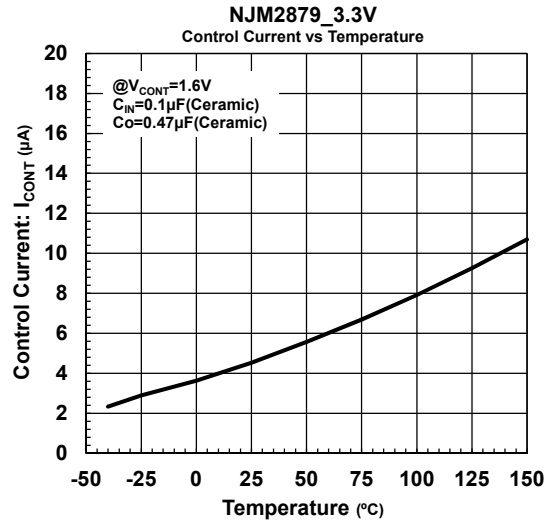
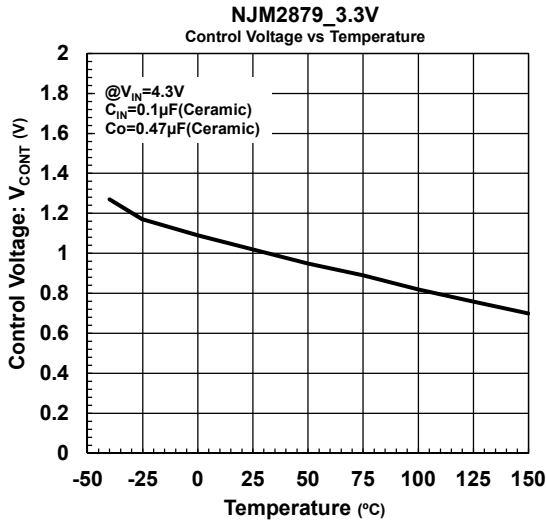

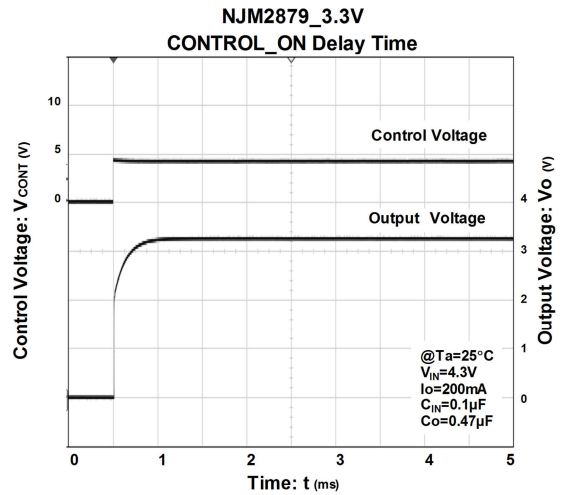
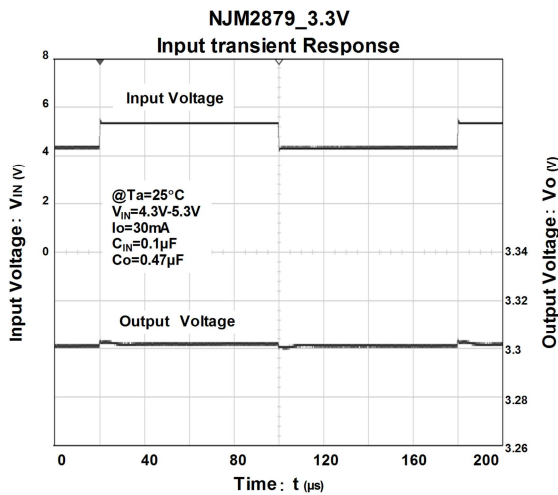
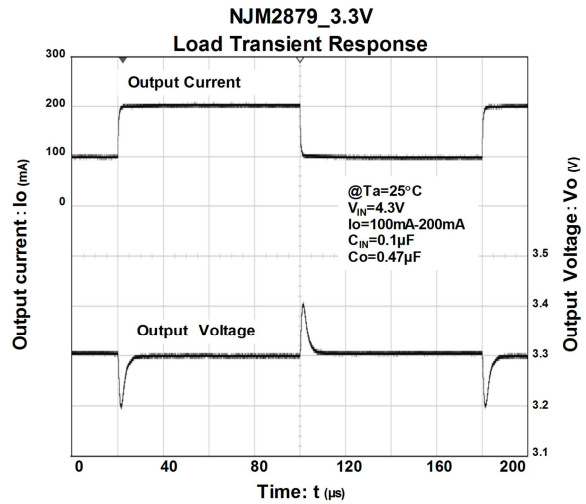
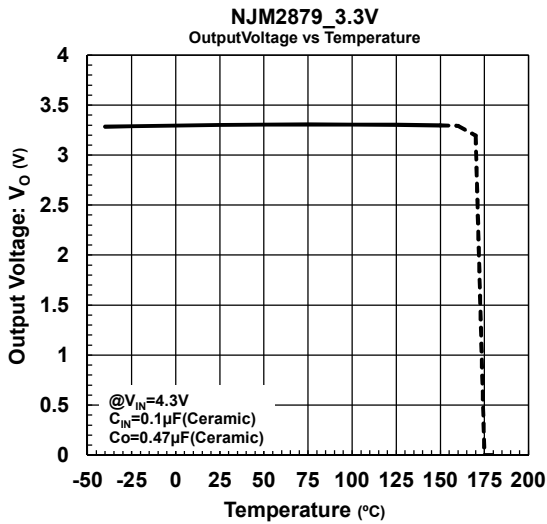
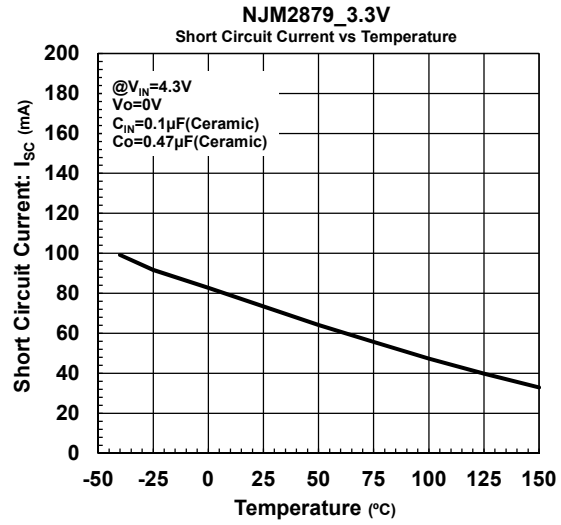
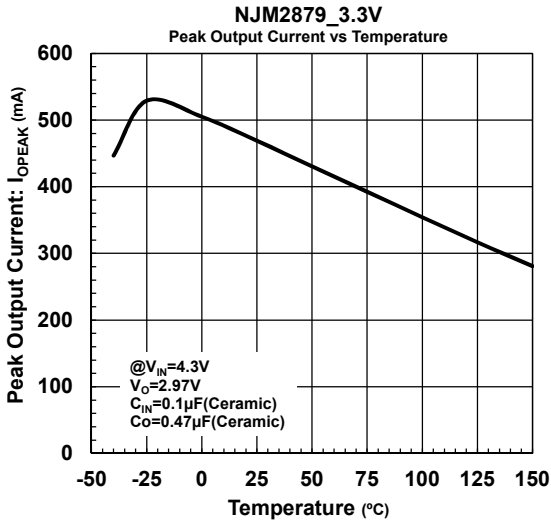

■ TYPICAL APPLICATION

1. In the case where ON/OFF Control is not required

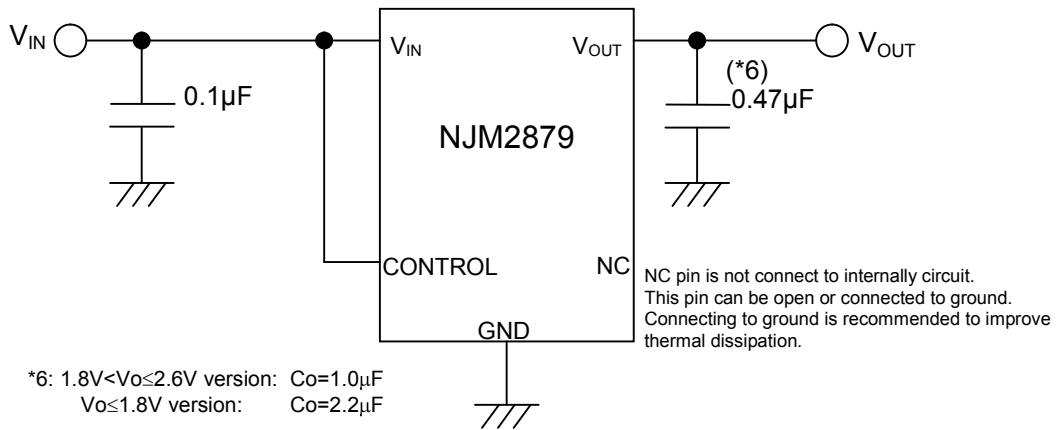

Connect CONTROL Pin to V_{IN} Pin

2. In use of ON/OFF CONTROL

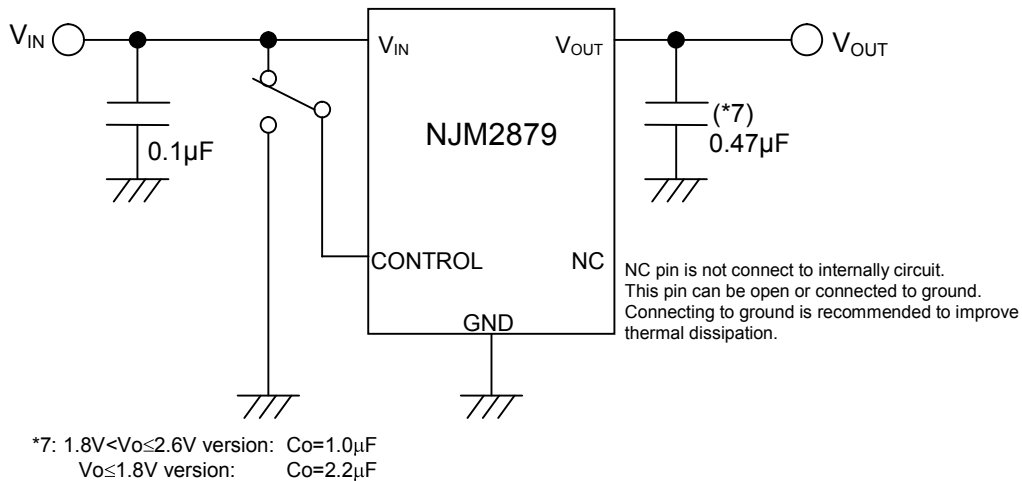

State of CONTROL Pin:

“H” → output is enabled.

“L” or “open” → output is disabled

■APPLICATION NOTE / GLOSSARY

*Reverse Current Protection

The NJM2879 has built-in Reverse Current Protection circuit.

This circuit prevents the large reverse current when output voltage is higher than input voltage.

Therefore external schottky-barrier diode(SBD) is not required

*Discharge Function

The NJM2879 has a built-in discharge circuit to discharge the charged output capacitors.

Discharge circuit operates when the CONTROL Pin is set in LOW level. The circuit discharges the charged output capacitors rapidly.

PACKAGE DIMENSIONS

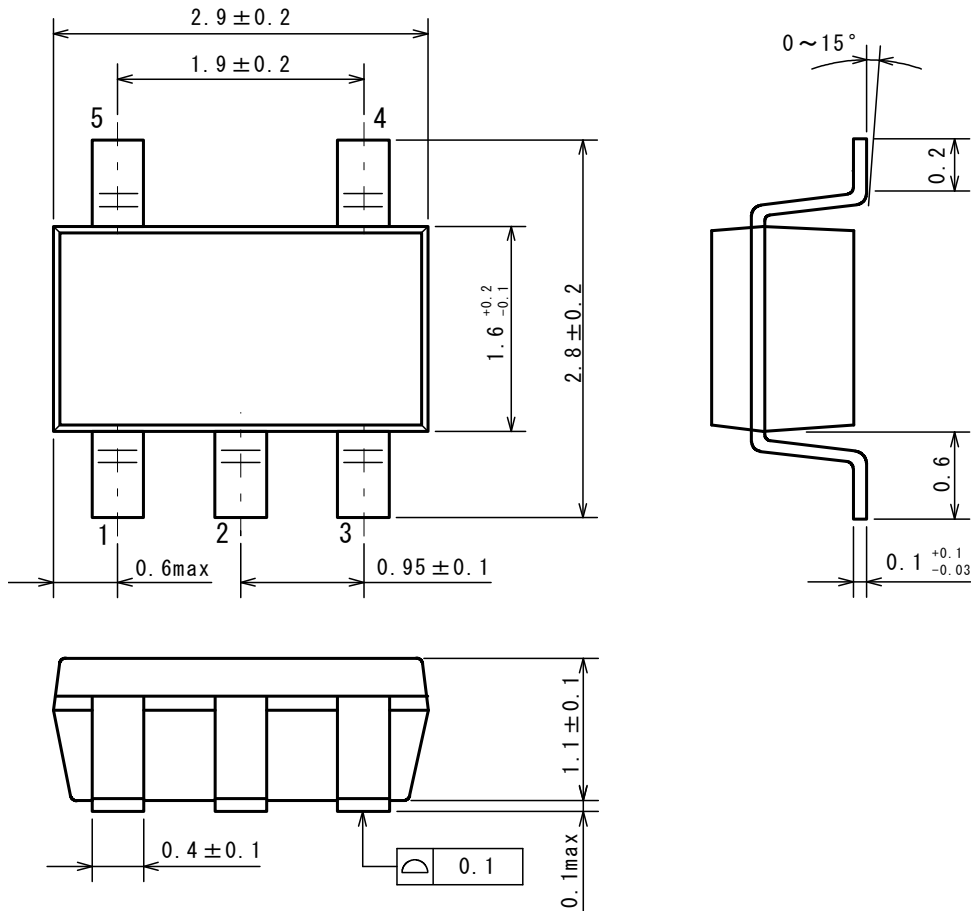

EXAMPLE OF SOLDER PADS DIMENSIONS

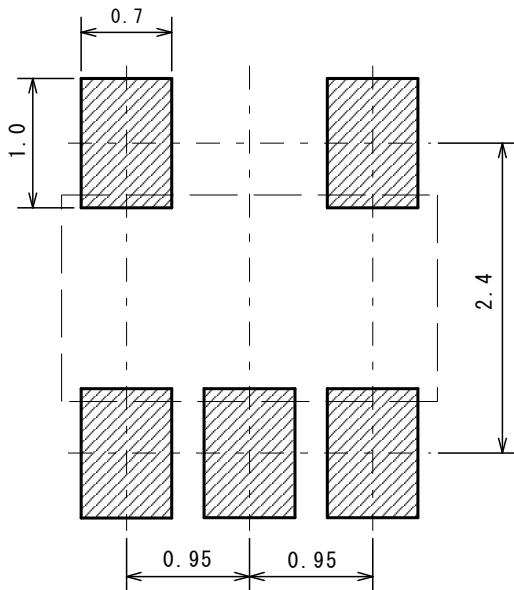

PACKING SPEC

TAPING DIMENSIONS

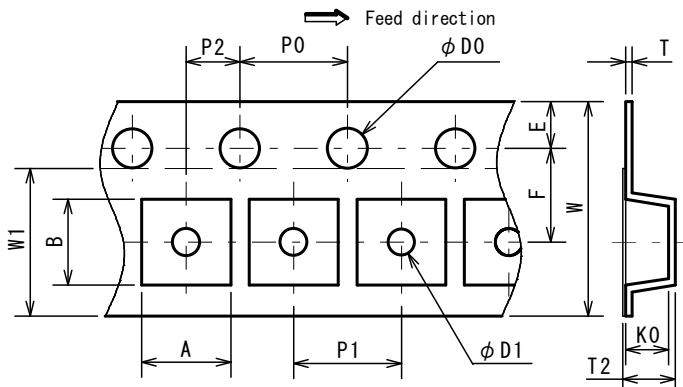

SYMBOL	DIMENSION	REMARKS
A	3.3±0.1	BOTTOM DIMENSION
B	3.2±0.1	BOTTOM DIMENSION
D0	1.55	
D1	1.05	
E	1.75±0.1	
F	3.5±0.05	
P0	4.0±0.1	
P1	4.0±0.1	
P2	2.0±0.05	
T	0.25±0.05	
T2	1.82	
K0	1.5±0.1	
W	8.0±0.3	
W1	5.5	THICKNESS 0.1MAX

REEL DIMENSIONS

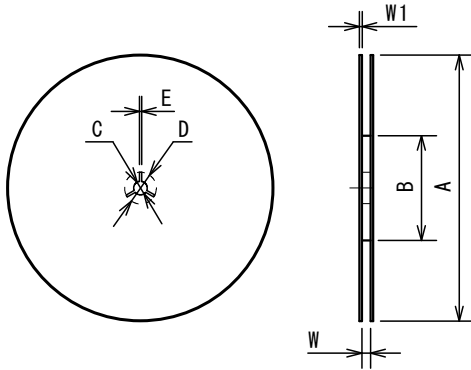

SYMBOL	DIMENSION
A	φ180±1
B	φ60±1
C	φ13±0.2
D	φ21±0.8
E	2±0.5
W	9±0.5
W1	1.2±0.2

TAPING STATE

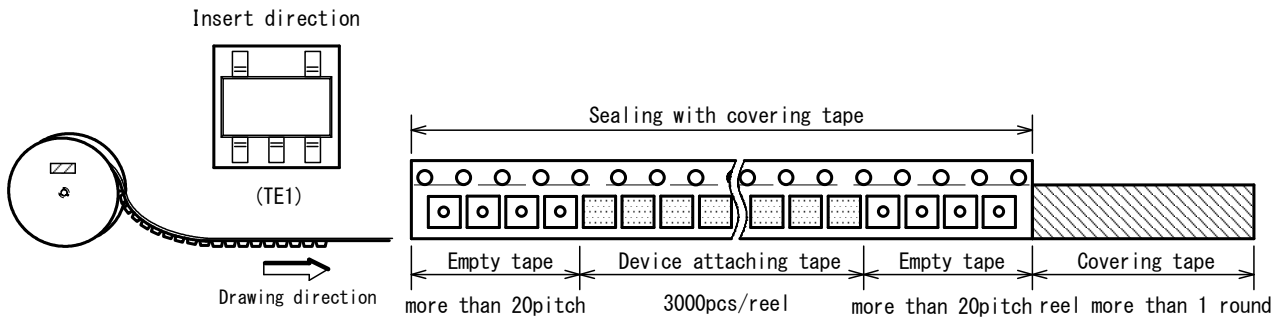

PACKING STATE

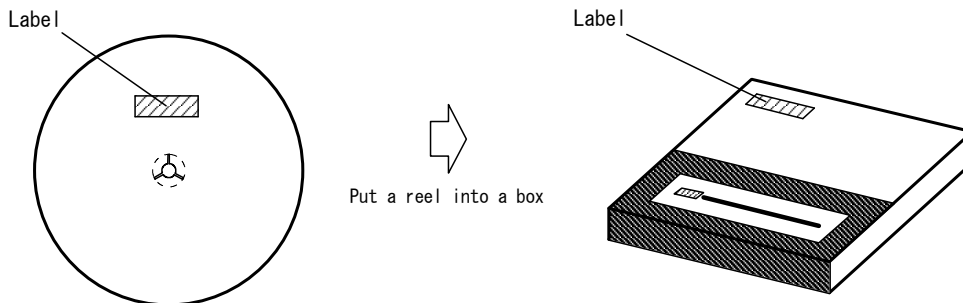

RECOMMENDED MOUNTING METHOD

INFRARED REFLOW SOLDERING METHOD

Recommended reflow soldering procedure

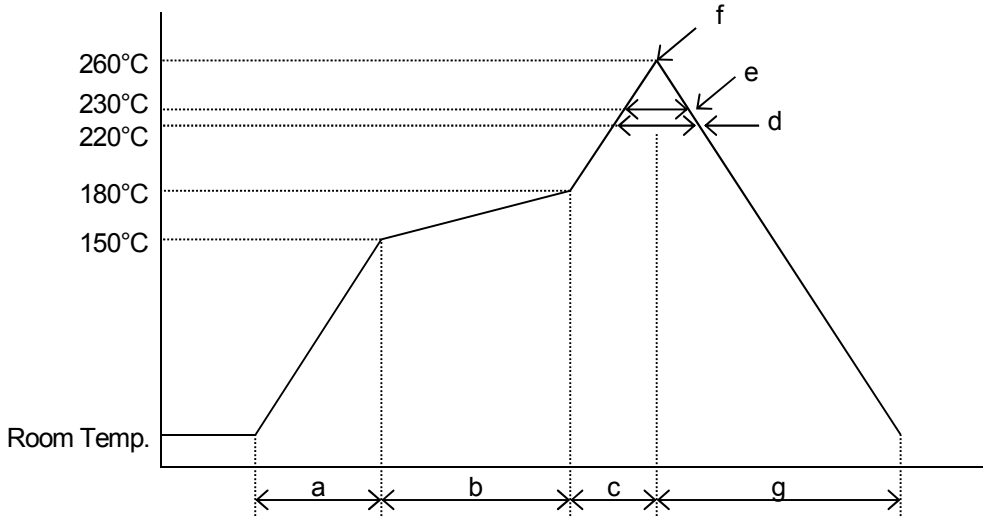

- | | |
|---------------------------------|--------------------------------|
| a: Temperature ramping rate | : 1 to 4°C/s |
| b: Pre-heating temperature time | : 150 to 180°C
: 60 to 120s |
| c: Temperature ramp rate | : 1 to 4°C/s |
| d: 220°C or higher time | : Shorter than 60s |
| e: 230°C or higher time | : Shorter than 40s |
| f: Peak temperature | : Lower than 260°C |
| g: Temperature ramping rate | : 1 to 6°C/s |

The temperature indicates at the surface of mold package.

■REVISION HYSTORY

DATE	REVISION	CHANGES
8.Aug.2017	Ver.1.0	New Release Automotive "H" spec.
19.Sep.2017	Ver.1.1	Add the Typical Characteristics graphs. Revise the "Load Regulation" spec.
20.Dec.2017	Ver.1.2	Added conformity with AEC-Q100 to FEATURES section

[CAUTION]

1. New JRC strives to produce reliable and high quality semiconductors. New JRC's semiconductors are intended for specific applications and require proper maintenance and handling. To enhance the performance and service of New JRC's semiconductors, the devices, machinery or equipment into which they are integrated should undergo preventative maintenance and inspection at regularly scheduled intervals. Failure to properly maintain equipment and machinery incorporating these products can result in catastrophic system failures
2. The specifications on this datasheet are only given for information without any guarantee as regards either mistakes or omissions. The application circuits in this datasheet are described only to show representative usages of the product and not intended for the guarantee or permission of any right including the industrial rights.
All other trademarks mentioned herein are property of their respective companies.
3. To ensure the highest levels of reliability, New JRC products must always be properly handled.
The introduction of external contaminants (e.g. dust, oil or cosmetics) can result in failures of semiconductor products.
4. New JRC offers a variety of semiconductor products intended for particular applications. It is important that you select the proper component for your intended application. You may contact New JRC's Sale's Office if you are uncertain about the products listed in this catalog.
5. Special care is required in designing devices, machinery or equipment which demand high levels of reliability. This is particularly important when designing critical components or systems whose failure can foreseeably result in situations that could adversely affect health or safety. In designing such critical devices, equipment or machinery, careful consideration should be given to amongst other things, their safety design, fail-safe design, back-up and redundancy systems, and diffusion design.
6. The products listed in the catalog may not be appropriate for use in certain equipment where reliability is critical or where the products may be subjected to extreme conditions. You should consult our sales office before using the products in any of the following types of equipment.

Aerospace Equipment
Equipment Used in the Deep sea
Power Generator Control Equipment (Nuclear, Steam, Hydraulic)
Life Maintenance Medical Equipment
Fire Alarm/Intruder Detector
Vehicle Control Equipment (airplane, railroad, ship, etc.)
Various Safety devices
7. New JRC's products have been designed and tested to function within controlled environmental conditions. Do not use products under conditions that deviate from methods or applications specified in this catalog. Failure to employ New JRC products in the proper applications can lead to deterioration, destruction or failure of the products. New JRC shall not be responsible for any bodily injury, fires or accident, property damage or any consequential damages resulting from misuse or misapplication of its products. Products are sold without warranty of any kind, either express or implied, including but not limited to any implied warranty of merchantability or fitness for a particular purpose.
8. Warning for handling Gallium and Arsenic(GaAs) Products (Applying to GaAs MMIC, Photo Reflector). This Products uses Gallium(Ga) and Arsenic(As) which are specified as poisonous chemicals by law. For the prevention of a hazard, do not burn, destroy, or process chemically to make them as gas or power. When the product is disposed, please follow the related regulation and do not mix this with general industrial waste or household waste.
9. The product specifications and descriptions listed in this catalog are subject to change at any time, without notice.

