

LOW DROPOUT VOLTAGE REGULATOR

■ GENERAL DESCRIPTION

The NJM2837 is a 1A output low dropout voltage regulator. This product has Reverse Current Protection without external SBD

Advanced Bipolar technology achieves low noise, high ripple rejection and high supply voltage.

2.4V to 15V output voltage range, 2.2 μ F small decoupling capacitor, built-in noise bypass capacitor make the NJM2837 suitable for various applications.

■ PACKAGE OUTLINE

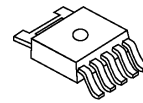

NJM2837DL3

■ FEATURES

- Output voltage options available 2.4 to 15.0V
- High Ripple Rejection 80dB typ. (f=1kHz, V_O=3V Version)
- Output Noise Voltage V_{no}=45 μ V_{rms} typ.
- Output capacitor with 2.2 μ F ceramic capacitor (V_O≥5.1V)
- Output Current I_O(max.)=1A
- High Precision Output V_O±1.0%
- Low Dropout Voltage 0.2V typ. (I_O=600mA)
- Internal Thermal Overload Protection
- Internal Over Current Protection
- Bipolar Technology
- Package Outline TO-252-5

■ PIN CONFIGURATION

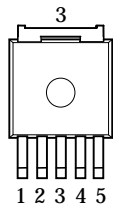

NJM2837DL3

PIN FUNCTION

1. CONTROL
2. V_{IN}
3. GND
4. V_O
5. NC

■ EQUIVALENT CIRCUIT

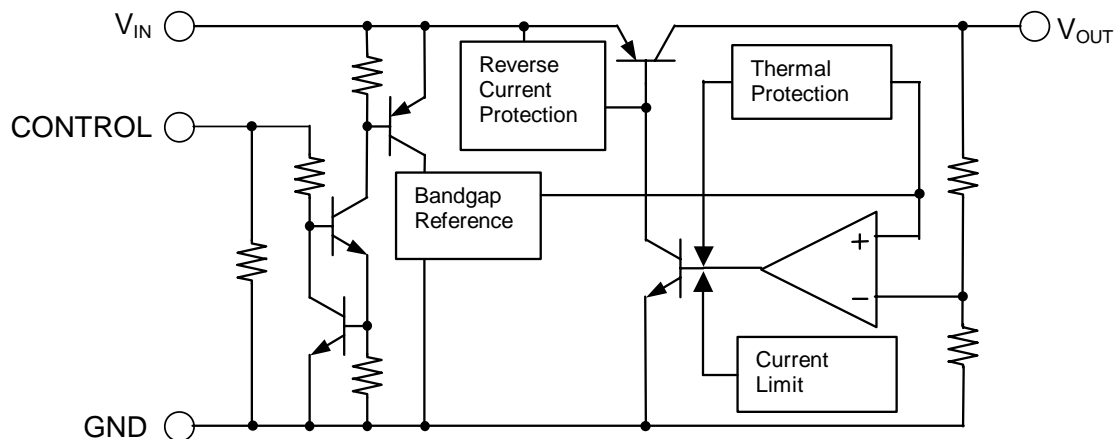

■ OUTPUT VOLTAGE RANK LIST

Device Name	V _{OUT}	Device Name	V _{OUT}
NJM2837DL3-24	2.4V	NJM2837DL3-85	8.5V
NJM2837DL3-03	3.0V	NJM2837DL3-12	12.0V
NJM2837DL3-05	5.0V	NJM2837DL3-15	15.0V

■ ABSOLUTE MAXIMUM RATINGS (Ta=25°C)

PARAMETER	SYMBOL	RATINGS	UNIT
Input Voltage	V _{IN}	+20	V
Control Voltage	V _{CONT}	+20	V
Output Terminal Voltage	V _{o.max}	V _O +1	V
Power Dissipation	P _D	1190 (*1) 3125(*2)	mW
Operating Temperature	Topr	-40 to +85	°C
Storage Temperature	Tstg	-40 to +150	°C

(*1): Mounted on glass epoxy board. (76.2 × 114.3 × 1.6mm:based on EIA/JDEC standard size, 2Layers, Cu area 100mm²)

(*2): Mounted on glass epoxy board. (76.2 × 114.3 × 1.6mm:based on EIA/JDEC standard, 4Layers)

(For 4Layers: Applying 74.2 × 74.2mm inner Cu area and a thermal via hole to a board based on JEDEC standard JESD51-5)

■ ELECTRICAL CHARACTERISTICS

(V_{IN}=V_O+1V, C_{IN}=1.0μF, C_O=2.2μF (2.9V<V_O≤5V: C_O=4.7μF, V_O≤2.9V:C_O=10μF), Ta=25°C)

PARAMETER	SYMBOL	TEST CONDITION	MIN	TYP	MAX	UNIT	
Output Voltage	V _O	I _O =30mA	-1.0%	-	+1.0%	V	
Quiescent Current	I _Q	I _O =0mA	V _O ≤5V Version	-	420	570	μA
			5V<V _O ≤10V Version	-	435	585	μA
			10V<V _O ≤15V Version	-	450	600	μA
Quiescent Current at Control OFF	I _{Q(OFF)}	V _{CONT} =0V	-	-	100	nA	
Output Current	I _O	V _O ×0.9V	1000	1300	-	mA	
Line Regulation	ΔV _O /ΔV _{IN}	V _{IN} =V _O +1V to V _O +6V(V _O ≤12V), V _{IN} =V _O +1V to 18V(V _O >12V), I _O =30mA	-	-	0.10	%/V	
Load Regulation	ΔV _O /ΔI _O	I _O =0 to 1000mA	-	-	0.004	%/mA	
Dropout Voltage	ΔV _{I-O}	I _O =600mA	-	0.20	0.28	V	
Ripple Rejection	RR	e _{in} =200mVrms, f=1kHz, I _O =10mA	See Fig.1			dB	
Average Temperature Coefficient of Output Voltage	ΔV _O /ΔTa	Ta=0 to 85°C, I _O =10mA	-	± 50	-	ppm/°C	
Output Noise Voltage	V _{NO}	f=10Hz to 80kHz, I _O =10mA	See Fig.1			μVrms	
Control Current	I _{CONT}	V _{CONT} =1.6V	-	3	12	μA	
Control Voltage for ON-state	V _{CONT(ON)}		1.6	-	-	V	
Control Voltage for OFF-state	V _{CONT(OFF)}		-	-	0.6	V	
Input Voltage	V _{IN}		-	-	18	V	

Fig. 1

Output Voltage	Ripple Rejection				Output Noise Voltage			
	MIN.	TYP.	MAX.	Unit	MIN.	TYP.	MAX.	Unit
2.4V	-	82	-	dB	-	41	-	μ Vrms
3.0V	-	80	-		-	45	-	
5.0V	-	77	-		-	68	-	
8.5V	-	73	-		-	107	-	
12.0V	-	70	-		-	148	-	
15.0V	-	68	-		-	173	-	

■ TEST CIRCUIT

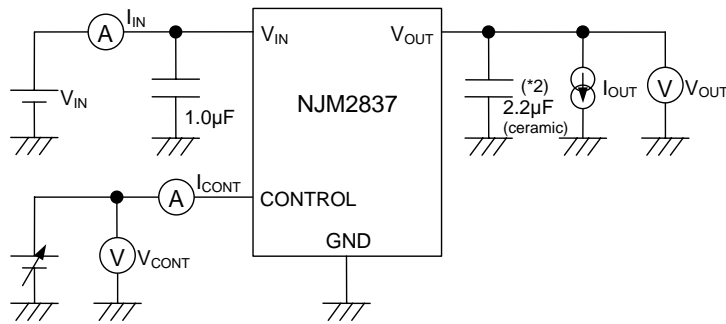

(*2) 2.9V < V_{OS} ≤ 5.0V version: C_o = 4.7µF (ceramic)
 V_{OS} ≤ 2.9V version: C_o = 10µF (ceramic)

■ TYPICAL APPLICATION

① In the case where ON/OFF Control is not required:

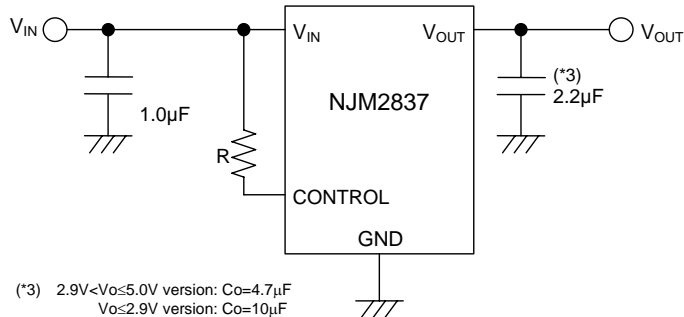

(*3) 2.9V < V_{OS} ≤ 5.0V version: C_o = 4.7µF
 V_{OS} ≤ 2.9V version: C_o = 10µF

Connect control terminal to V_{IN} terminal

② In use of ON/OFF CONTROL:

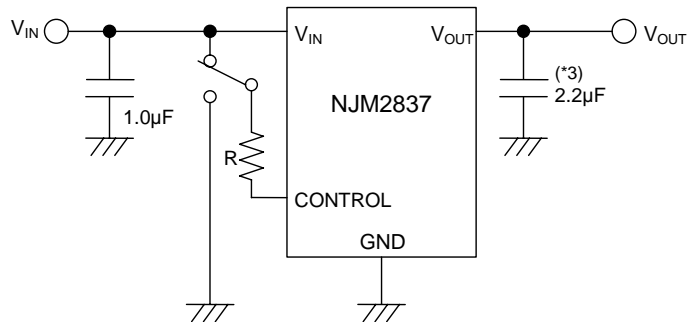

(*3) 2.9V < V_{OS} ≤ 5.0V version: C_o = 4.7µF
 V_{OS} ≤ 2.9V version: C_o = 10µF

State of control terminal: "H" → output is enabled. "L" or "open" → output is disabled.

***Input Capacitance C_{IN}**

Input Capacitance C_{IN} is required to prevent oscillation and reduce power supply ripple for applications with high power supply impedance or a long power supply line.

You should use the C_{IN} value of 0.1 μ F larger to avoid the problem.

C_{IN} should connect between GND and V_{IN} as short as possible.

***In the case of using a resistance "R" between V_{IN} and control.**

The current flow into the control terminal while the IC is ON state (I_{CONT}) can be reduced when a pull up resistance "R" is inserted between V_{IN} and the control terminal.

The minimum control voltage for ON state ($V_{CONT(ON)}$) is increased due to the voltage drop caused by I_{CONT} and the resistance "R". The I_{CONT} is temperature dependence as shown in the "Control Current vs. Temperature" characteristics. Therefore, the resistance "R" should be carefully selected to ensure the control voltage exceeds the $V_{CONT(ON)}$ over the required temperature range.

***Output Capacitance C_O**

Output capacitor (C_O) will be required for a phase compensation of the internal error amplifier.

The capacitance and the equivalent series resistance (ESR) influence to stable operation of the regulator.

This product is designed to work with a low ESR capacitor (C_O). However use of recommended capacitance or larger value is effective for stable operation.

Use of a smaller C_O may cause excess output noise or oscillation of the regulator due to lack of the phase compensation.

Therefore use C_O with the recommended capacitance or larger value and connect between V_O terminal and GND terminal with shortest path. The recommended capacitance depends on the output voltage rank. Low voltage regulator requires larger value C_O . Thus, check the recommended capacitance for each output voltage rank.

Use of a larger C_O reduces output noise and ripple output, and also improves output transient response against rapid load change.

***Reverse Current Protection**

A reverse current protection circuit is built-in to this product and prevents a current inflow from an Output terminal to the Input terminal when the input terminal voltage became lower than the output terminal voltage.

When a regulator is controlled by off ($V_{CONT} < 0.6V$), the reverse current protection circuit functions.

TYPICAL CHARACTERISTICS

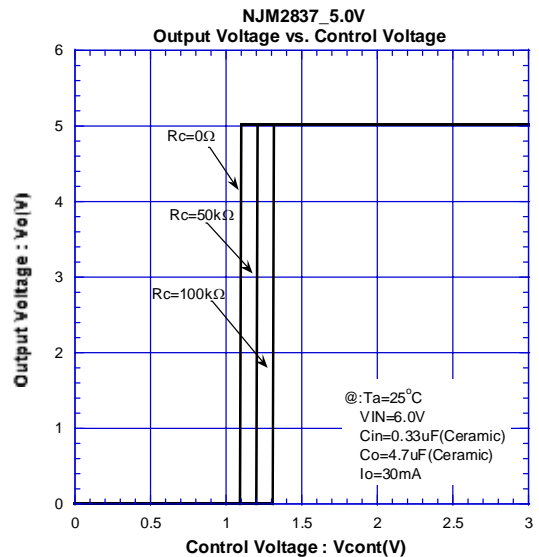
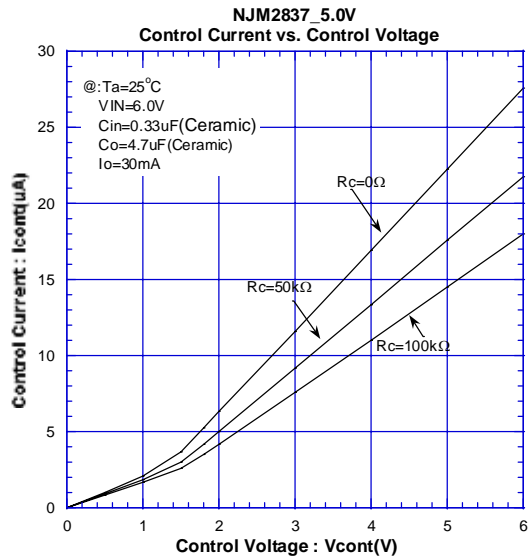
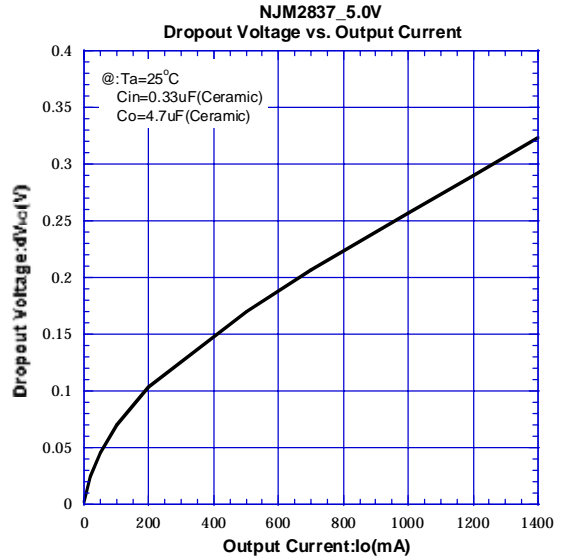
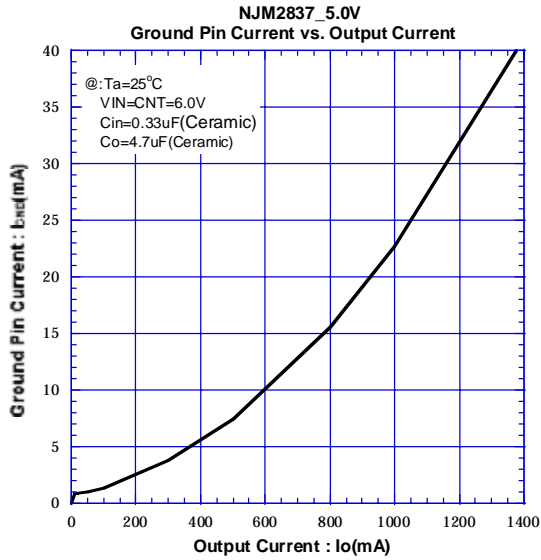
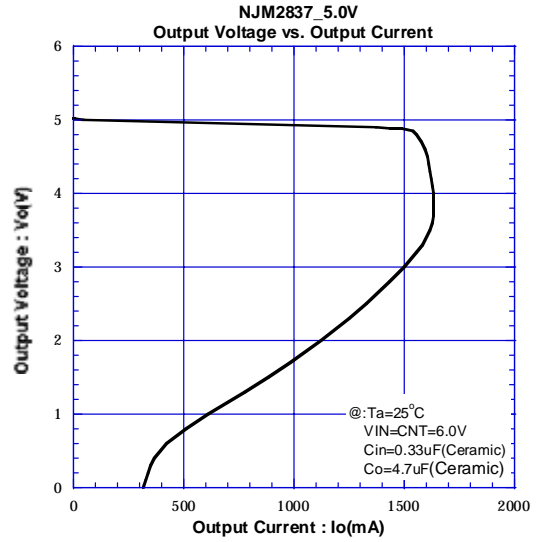
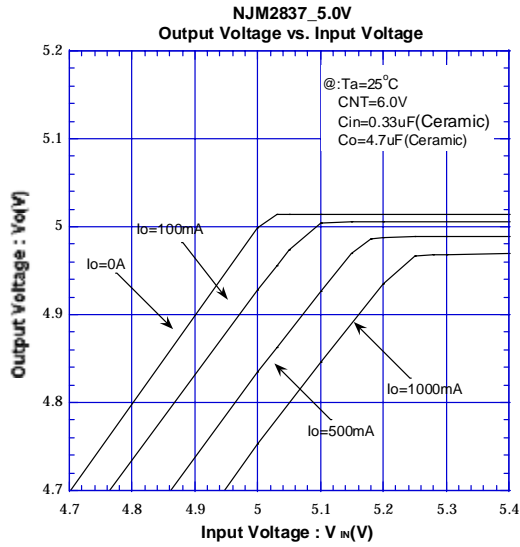

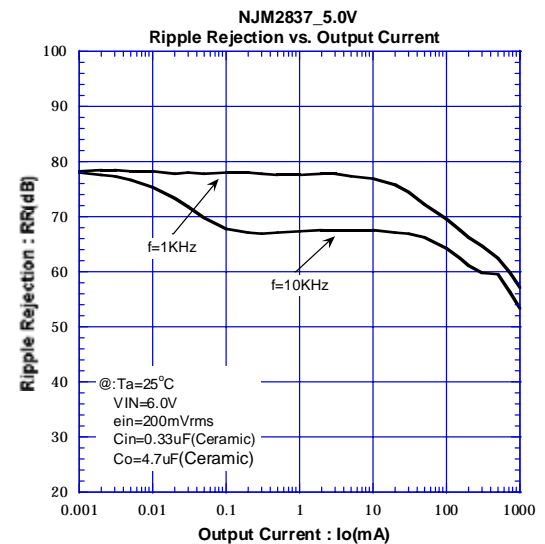
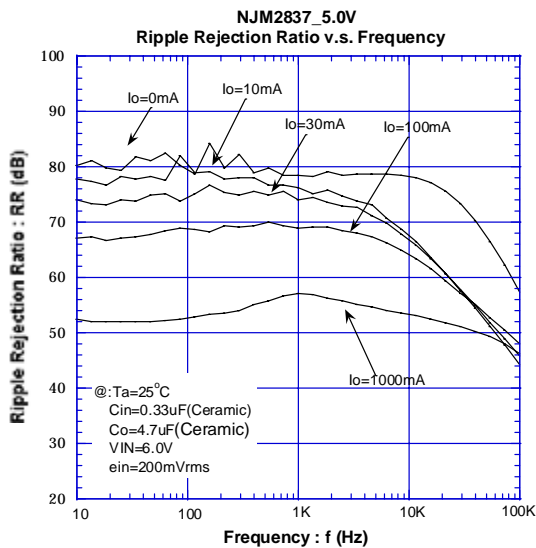
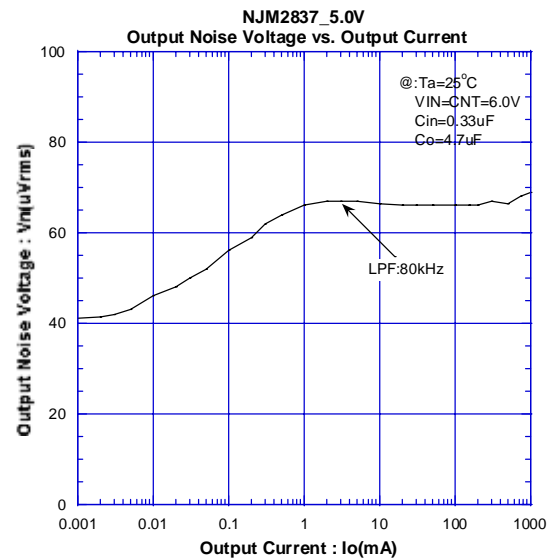
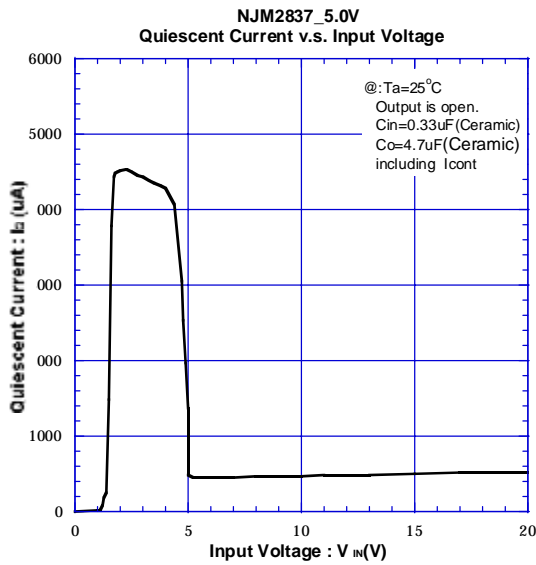
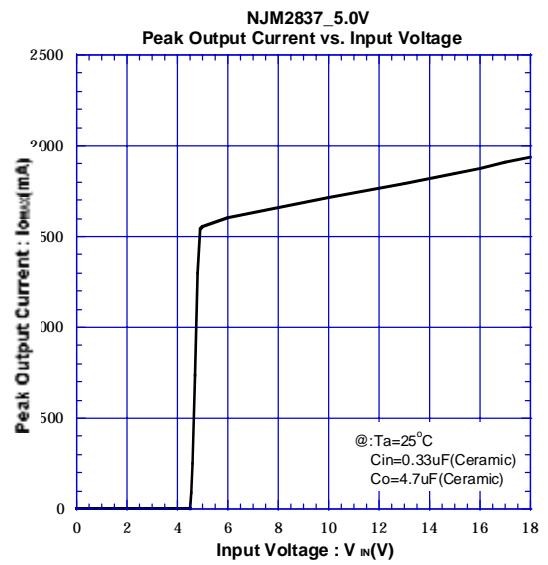
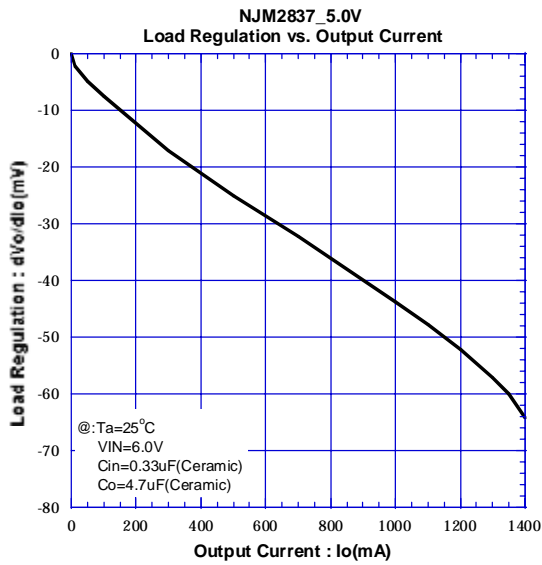

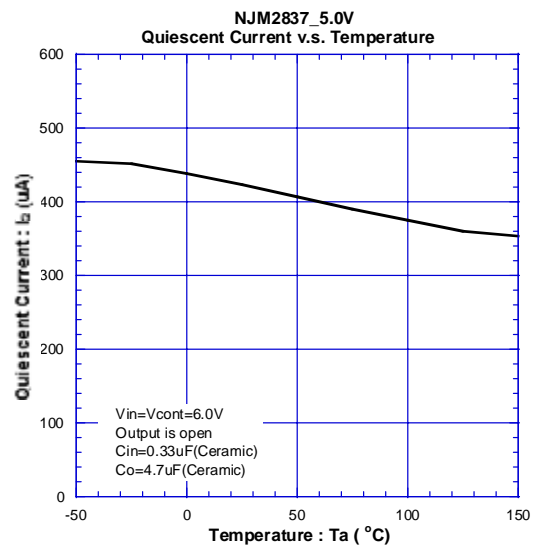
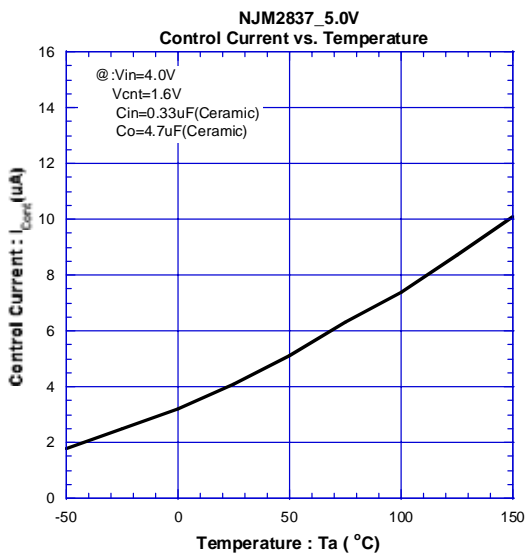
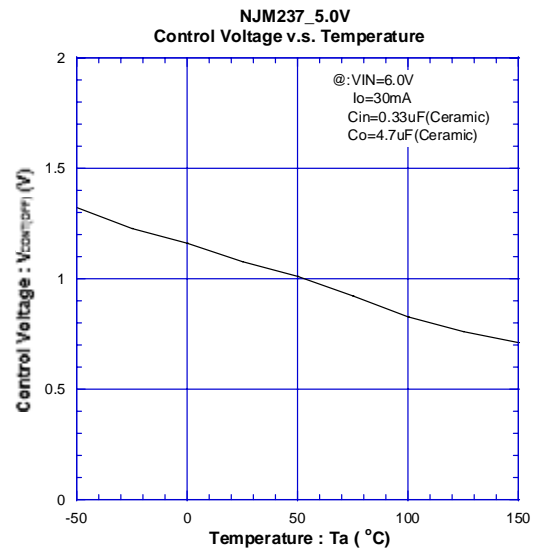
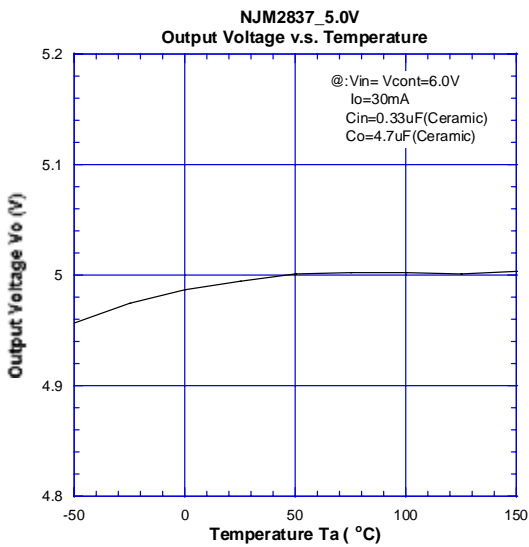
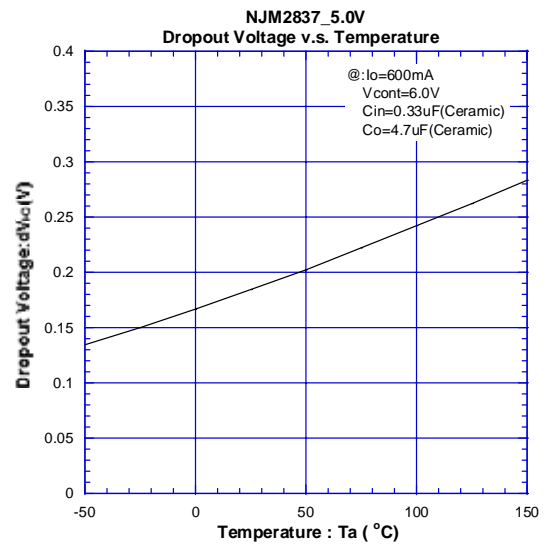
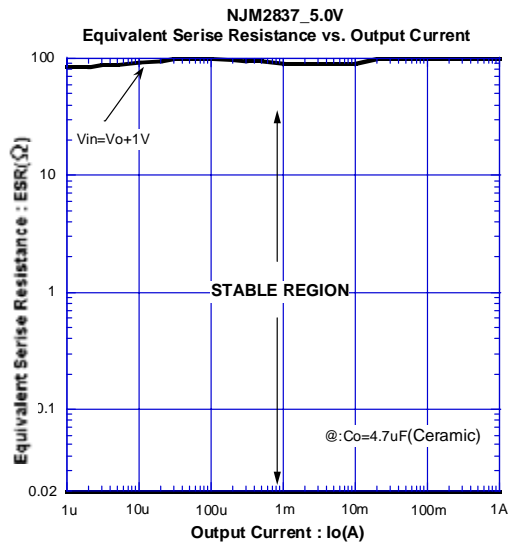

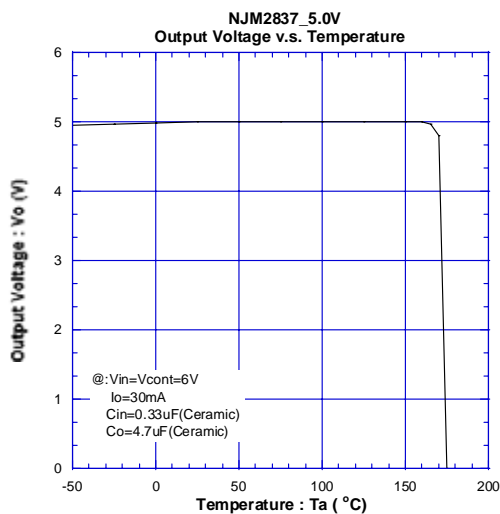
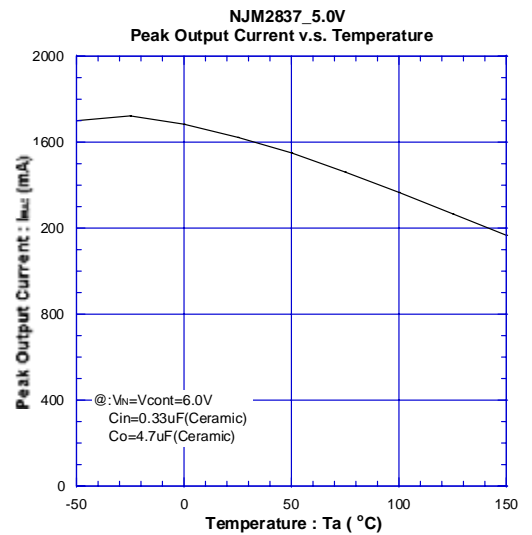
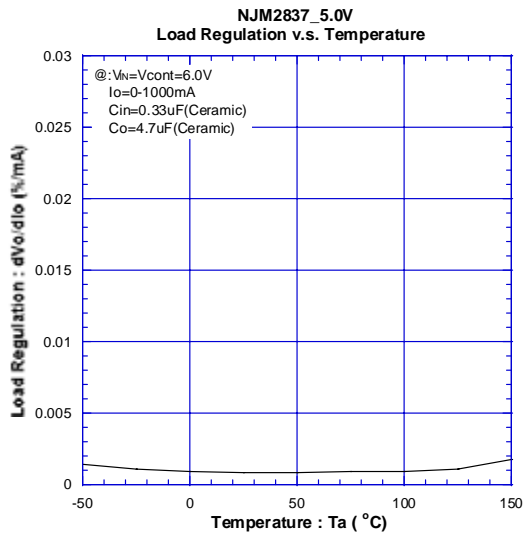
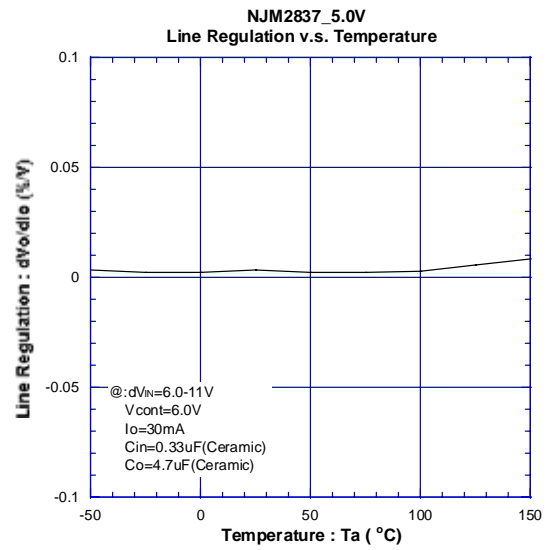
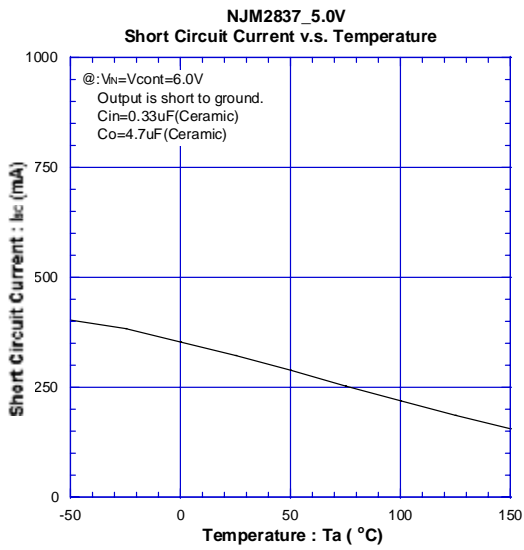

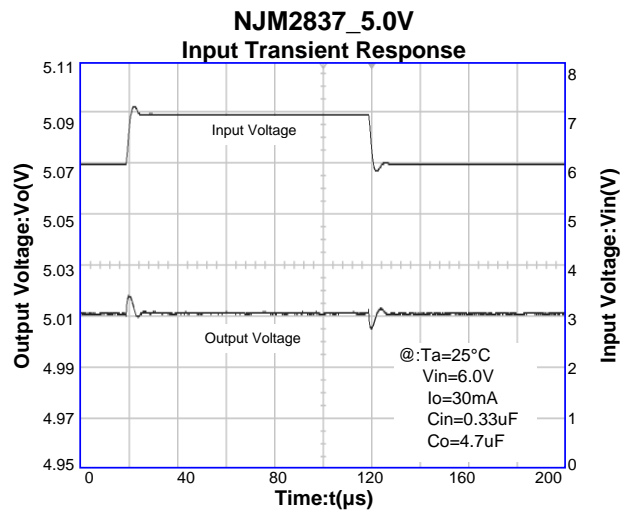
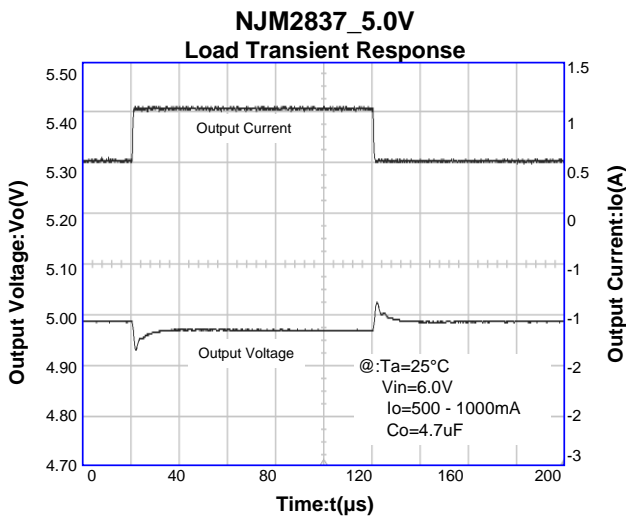
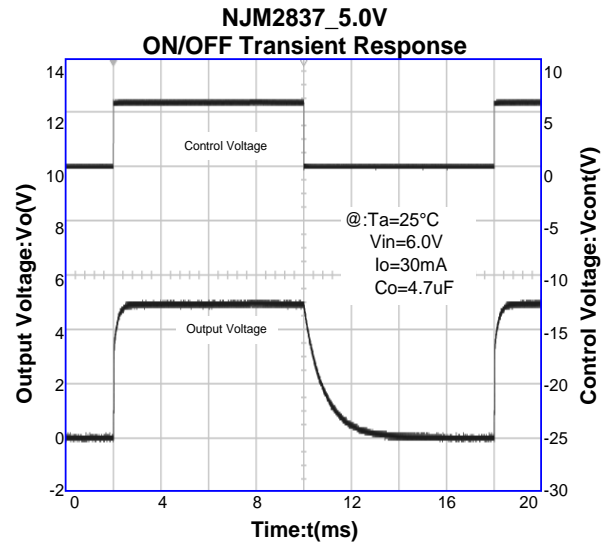
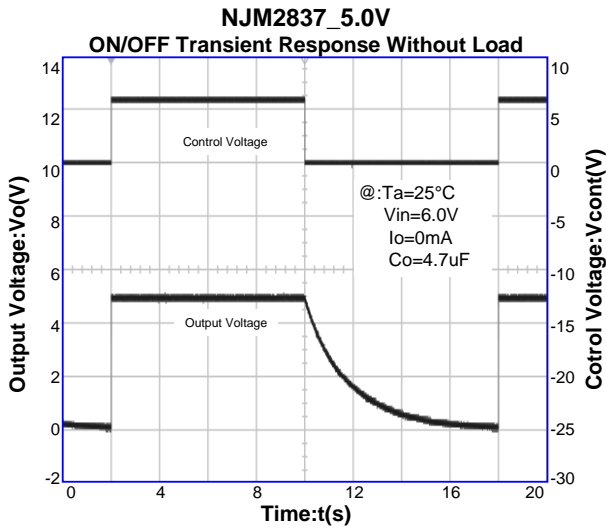

[CAUTION]

The specifications on this databook are only given for information, without any guarantee as regards either mistakes or omissions. The application circuits in this databook are described only to show representative usages of the product and not intended for the guarantee or permission of any right including the industrial rights.