

## LOW DROPOUT VOLTAGE REGULATOR

### ■ GENERAL DESCRIPTION

The NJM2831 is a 100mA output low dropout voltage regulator with ON/OFF control.

Advanced Bipolar technology achieves low noise, high ripple rejection and low quiescent current.

2.1V to 15.5V output voltage range, 1 $\mu$ F small decoupling capacitor, built-in noise bypass capacitor make the NJM2831 suitable for various applications.

### ■ PACKAGE OUTLINE

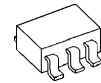

NJM2831F

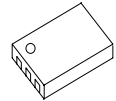

NJM2831KG1

### ■ FEATURES

- Output voltage options available 2.1 ~ 15.5V (0.1V step)
- High Ripple Rejection 75dB typ. (f=1kHz Vo=3V Version)
- Output Noise Voltage Vno=45 $\mu$ Vrms typ.
- Output capacitor with 1.0 $\mu$ F ceramic capacitor (Vo $\geq$ 5.1V)
- Output Current Io(max.)=100mA
- High Precision Output Vo $\pm$ 1.0%
- Low Dropout Voltage 0.10V typ. (Io=60mA)
- ON/OFF Control (Active High)
- Internal Short Circuit Current Limit
- Internal Thermal Overload Protection
- Bipolar Technology
- Package Outline SOT-23-5, ESON6-G1

### ■ PIN CONFIGURATION

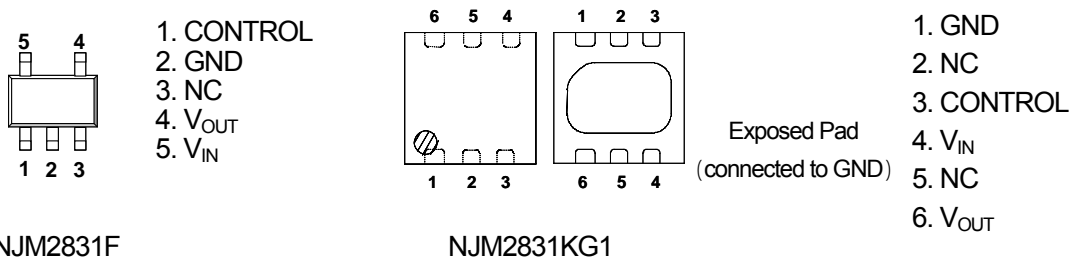

### ■ EQUIVALENT CIRCUIT

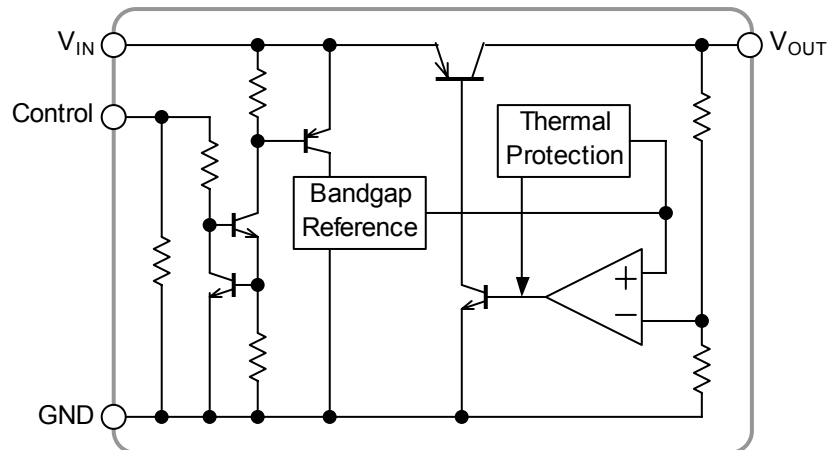

# NJM2831

## ■ OUTPUT VOLTAGE

The WHITE column shows applicable Voltage Rank(s)

Device Name	Vout	Device Name	Vout	Device Name	Vout
NJM2831F-21	2.1V	NJM2831F-41	4.1V	NJM2831F-116	11.6V
NJM2831F-22	2.2V	NJM2831F-42	4.2V	NJM2831F-12	12.0V
NJM2831F-23	2.3V	NJM2831F-43	4.3V	NJM2831F-125	12.5V
NJM2831F-24	2.4V	NJM2831F-44	4.4V	NJM2831F-13	13.0V
NJM2831F-25	2.5V	NJM2831F-45	4.5V	NJM2831F-135	13.5V
NJM2831F-26	2.6V	NJM2831F-46	4.6V	NJM2831F-15	15.0V
NJM2831F-27	2.7V	NJM2831F-47	4.7V	NJM2831F-155	15.5V
NJM2831F-28	2.8V	NJM2831F-48	4.8V		
NJM2831F-29	2.9V	NJM2831F-49	4.9V		
NJM2831F-03	3.0V	NJM2831F-05	5.0V		
NJM2831F-31	3.1V	NJM2831F-53	5.3V		
NJM2831F-32	3.2V	NJM2831F-06	6.0V		
NJM2831F-33	3.3V	NJM2831F-64	6.4V		
NJM2831F-34	3.4V	NJM2831F-07	7.0V		
NJM2831F-35	3.5V	NJM2831F-08	8.0V		
NJM2831F-36	3.6V	NJM2831F-82	8.2V		
NJM2831F-37	3.7V	NJM2831F-85	8.5V		
NJM2831F-38	3.8V	NJM2831F-09	9.0V		
NJM2831F-39	3.9V	NJM2831F-92	9.2V		
NJM2831F-04	4.0V	NJM2831F-10	10.0V		

ESON Type Available Voltage Rank(s)

Device Name	Vout	Device Name	Vout	Device Name	Vout
NJM2831KG1-33	3.3V	NJM2831KG1-52	5.2V		

## ■ ABSOLUTE MAXIMUM RATINGS (Ta=25°C)

PARAMETER	SYMBOL	RATINGS	UNIT	
Input Voltage	$V_{IN}$	+20	V	
Control Voltage	$V_{CONT}$	+20(*1)	V	
Power Dissipation	$P_D$	SOT-23-5	500(*2)	mW
			250(*3)	
		ESON6	420(*4)	
			1135(*5)	
Operating Temperature	$T_{opr}$	-40~+85	°C	
Storage Temperature	$T_{stg}$	-40~+150	°C	

(\*1): When input voltage is less than +20V, the absolute maximum control voltage is equal to the input voltage.

(\*2): Mounted on glass epoxy board based on EIA/JEDEC. (114.3x76.2x1.6mm: 2Layers)

(\*3): Device itself.

(\*4): Mounted on glass epoxy board based on EIA/JEDEC STANDARD.

(101.5x114.5x1.6mm: 2Layers FR-4, copper area 100mm<sup>2</sup>)

(\*5): Mounted on glass epoxy board based on EIA/JEDEC STANDARD. (101.5 × 114.5 × 1.6mm: 4Layers FR-4,

Internal foil area size: 99.5 × 99.5mm, Applying a thermal via hole to a board based on JEDEC standard JESD51-5)

## ■ ELECTRICAL CHARACTERISTICS

( $V_{IN}=V_o+1V$ ,  $C_{IN}=0.1\mu F$ ,  $C_o=1.0\mu F$  (2.8V< $V_o$ ≤5.4V:  $C_o=2.2\mu F$ ,  $V_o$ ≤2.8V:  $C_o=4.7\mu F$ ),  $T_a=25^\circ C$ )

PARAMETER	SYMBOL	TEST CONDITION	MIN.	TYP.	MAX.	UNIT	
Output Voltage	$V_o$	$I_o=30mA$	-1.0%	–	+1.0%	V	
Quiescent Current	$I_Q$	$I_o=0mA$ , except $I_{cont}$	$V_o \leq 5V$ Version	–	120	180	$\mu A$
			$5V < V_o \leq 10V$ Version	–	135	195	$\mu A$
			$10V < V_o \leq 15V$ Version	–	150	210	$\mu A$
Quiescent Current at Control OFF	$I_{Q(OFF)}$	$V_{CONT}=0V$	–	–	100	nA	
Output Current	$I_o$	$V_o=0.3V$	100	130	–	mA	
Line Regulation	$\Delta V_o / \Delta V_{IN}$	$V_{IN}=V_o+1V \sim V_o+6V$ ( $V_o \leq 12V$ Version) $V_{IN}=V_o+1V \sim 18V$ ( $V_o > 12V$ Version), $I_o=30mA$	–	–	0.10	%/V	
Load Regulation	$\Delta V_o / \Delta I_o$	$I_o=0 \sim 60mA$	–	–	0.03	%/mA	
Dropout Voltage(*4)	$\Delta V_{I-O}$	$I_o=60mA$	–	0.10	0.18	V	
Ripple Rejection	RR	$e_{in}=200mV_{rms}$ , $f=1kHz$ , $I_o=10mA$ , $V_o=3V$ Version	–	75	–	dB	
Average Temperature Coefficient of Output Voltage	$\Delta V_o / \Delta T_a$	$T_a=0 \sim 85^\circ C$ , $I_o=10mA$	–	± 50	–	ppm/ °C	
Output Noise Voltage	$V_{NO}$	$f=10Hz \sim 80kHz$ , $I_o=10mA$ $V_o=3V$ Version	–	45	–	$\mu V_{rms}$	
Control Current	$I_{cont}$	$V_{CONT}=1.6V$	–	3	12	$\mu A$	
Control Voltage for ON-state	$V_{CONT(ON)}$		1.6	–	–	V	
Control Voltage for OFF-state	$V_{CONT(OFF)}$		–	–	0.6	V	
Input Voltage	$V_{IN}$		–	–	18	V	

(\*4): The above specification is a common specification for all output voltages.

Therefore, it may be different from the individual specification for a specific output voltage.

# NJM2831

## ■ TEST CIRCUIT

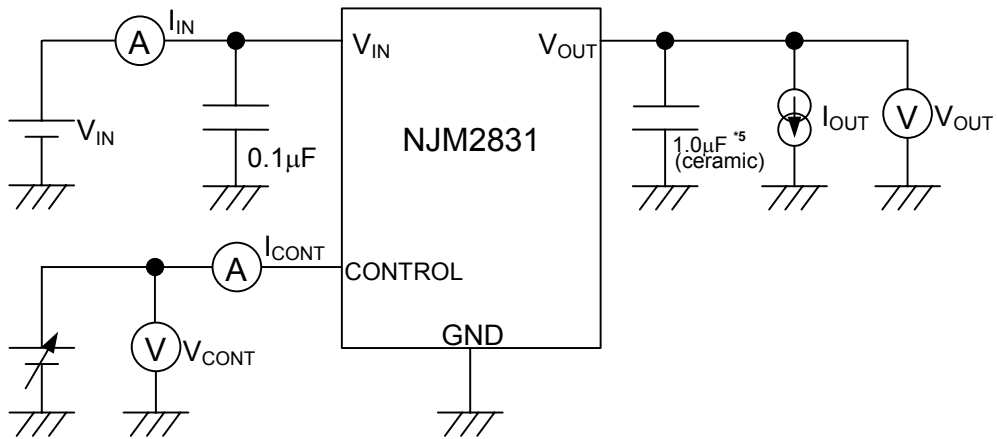

\*5 2.8V <  $V_o$  ≤ 5.4V version:  $C_o$  = 2.2 μF (ceramic)  
 $V_o$  ≤ 2.8V version:  $C_o$  = 4.7 μF (ceramic)

## ■ TYPICAL APPLICATIONS

① In the case where ON/OFF Control is not required:

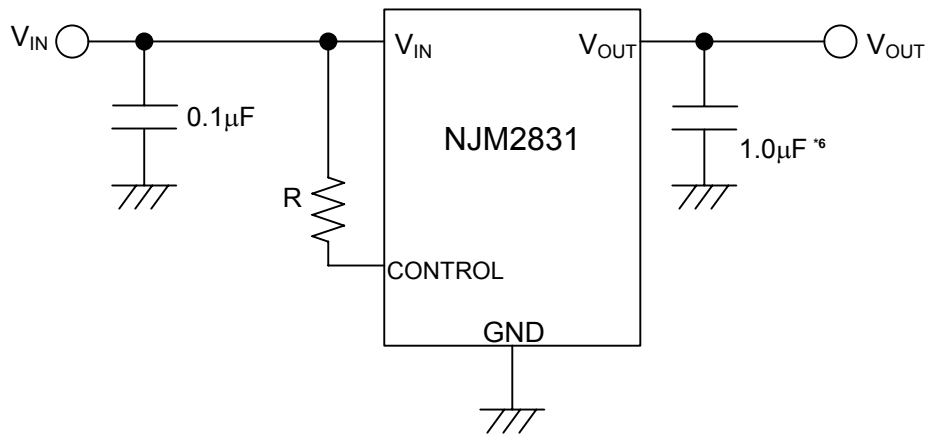

\*6 2.8V <  $V_o$  ≤ 5.4V version:  $C_o$  = 2.2 μF  
 $V_o$  ≤ 2.8V version:  $C_o$  = 4.7 μF

Connect control terminal to  $V_{IN}$  terminal

② In use of ON/OFF CONTROL:

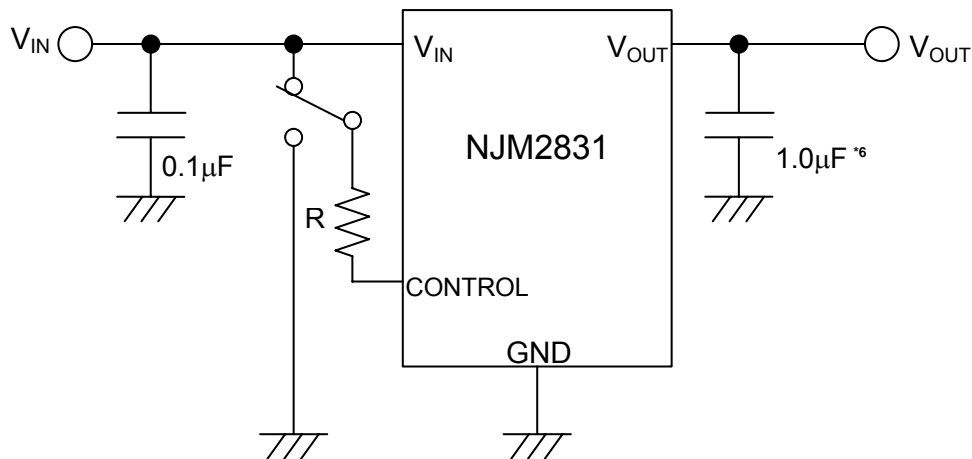

\*6 2.8V <math>V\_o \le 5.4V</math> version:  $C_o = 2.2\mu F$   
 $V_o \le 2.8V$  version:  $C_o = 4.7\mu F$

State of control terminal:

- "H" → output is enabled.
- "L" or "open" → output is disabled.

\*In the case of using a resistance "R" between  $V_{IN}$  and control.

The current flow into the control terminal while the IC is ON state ( $I_{CONT}$ ) can be reduced when a pull up resistance "R" is inserted between  $V_{IN}$  and the control terminal.

The minimum control voltage for ON state ( $V_{CONT(ON)}$ ) is increased due to the voltage drop caused by  $I_{CONT}$  and the resistance "R". The  $I_{CONT}$  is temperature dependence as shown in the "Control Current vs. Temperature" characteristics. Therefore, the resistance "R" should be carefully selected to ensure the control voltage exceeds the  $V_{CONT(ON)}$  over the required temperature range.

## \*Input Capacitance $C_{IN}$

Input capacitance  $C_{IN}$  is required to prevent oscillation and reduce power supply ripple for applications with high power supply impedance or a long power supply line.

Use the  $C_{IN}$  value of 0.1 $\mu$ F greater to avoid the problem.

$C_{IN}$  should connect between GND and  $V_{IN}$  as short as possible.

## \*Output Capacitance $C_O$

Output capacitor ( $C_O$ ) will be required for a phase compensation of the internal error amplifier.

The capacitance and the equivalent series resistance (ESR) influence to stable operation of the regulator.

This product is designed to work with a low ESR capacitor ( $C_O$ ). However use of recommended capacitance or larger value is effective for stable operation.

Use of a smaller  $C_O$  may cause excess output noise or oscillation of the regulator due to lack of the phase compensation.

Therefore use  $C_O$  with the recommended capacitance or larger value and connect between  $V_O$  terminal and GND terminal with shortest path. The recommended capacitance depends on the output voltage rank. Low voltage regulator requires larger value  $C_O$ . Thus, check the recommended capacitance for each output voltage rank.

In addition, You should consider varied characteristics of capacitor (a frequency characteristic, a temperature characteristic, a DC bias characteristic and so on) and unevenness peculiar to a capacitor supplier enough. We recommend that withstand voltage margin against output voltage and superior in a temperature characteristic, when selecting Output capacitor.

Uses of a larger  $C_O$  reduces output noise and ripple output, and also improves output transient response against rapid load change.

## TYPICAL CHARACTERISTICS

### DC CHARACTERISTICS (3V Version)

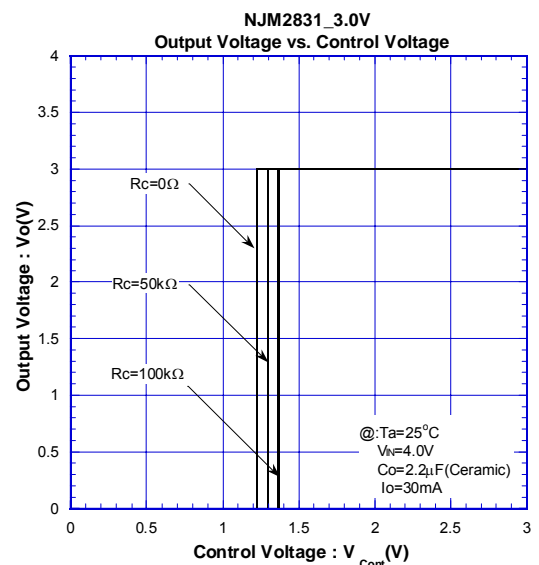
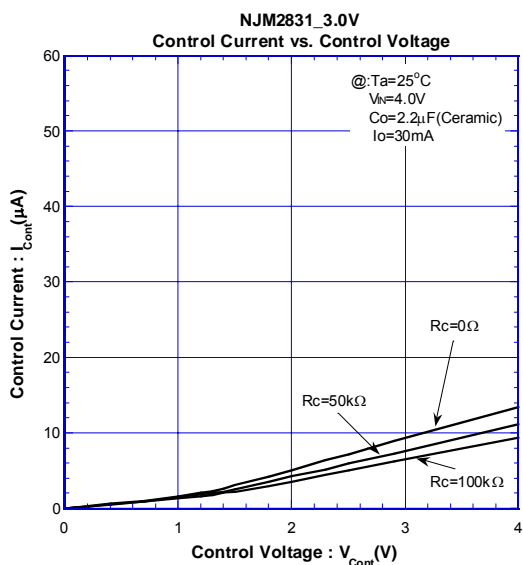
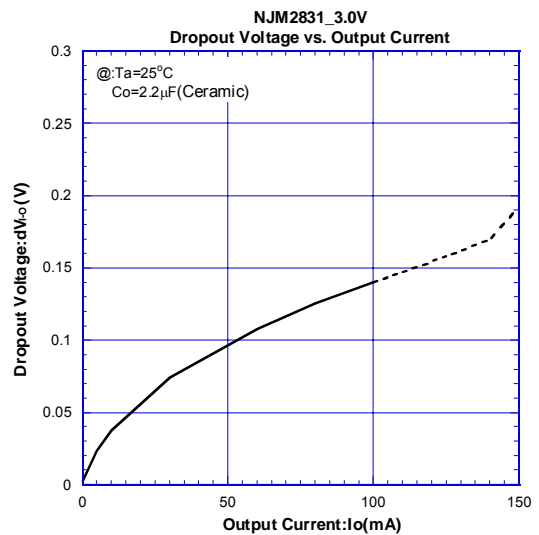
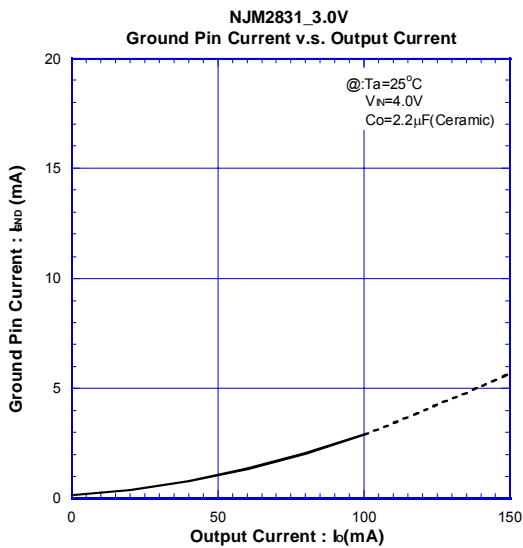
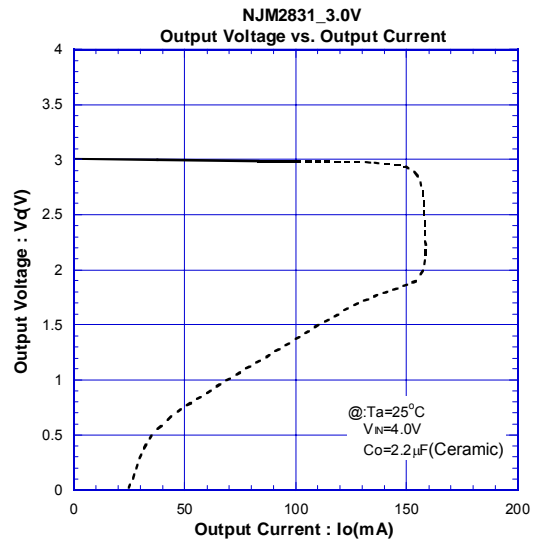
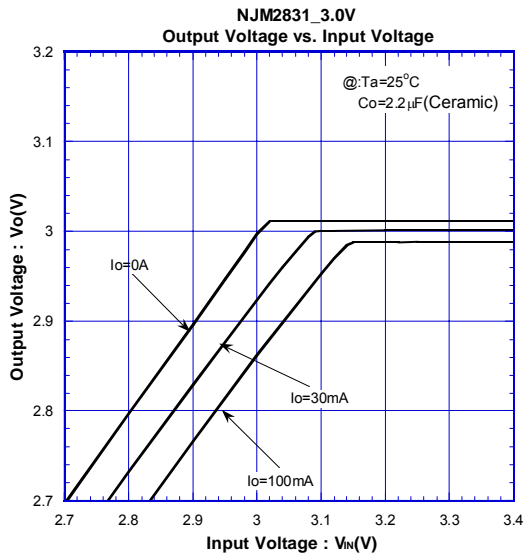

# NJM2831

## TYPICAL CHARACTERISTICS

### DC CHARACTERISTICS (3V Version)

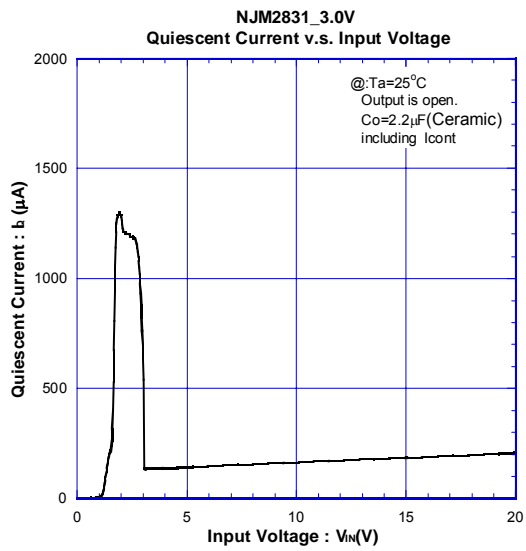
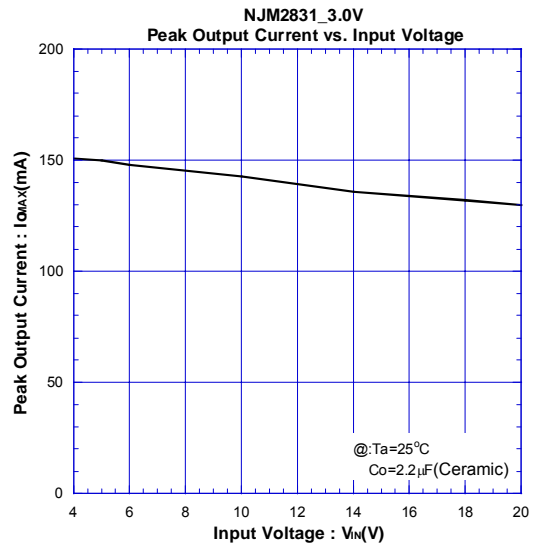
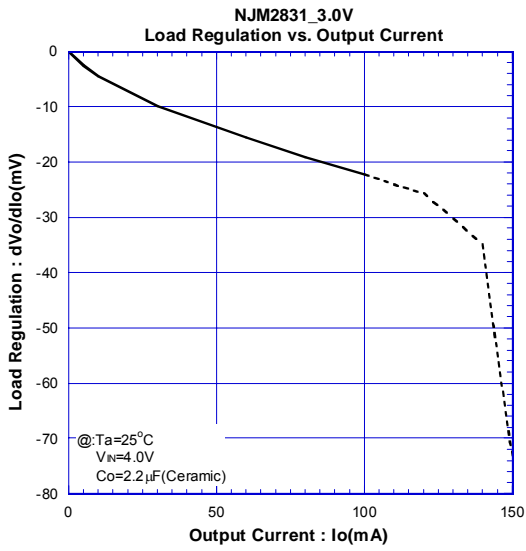



## TYPICAL CHARACTERISTICS

### ●AC CHARACTERISTICS (3V Version)

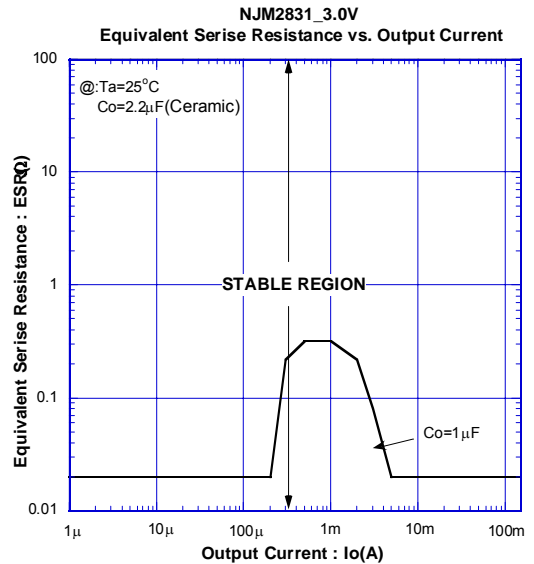
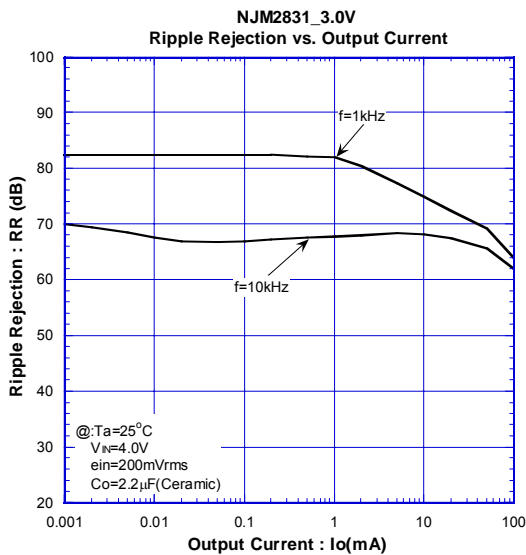
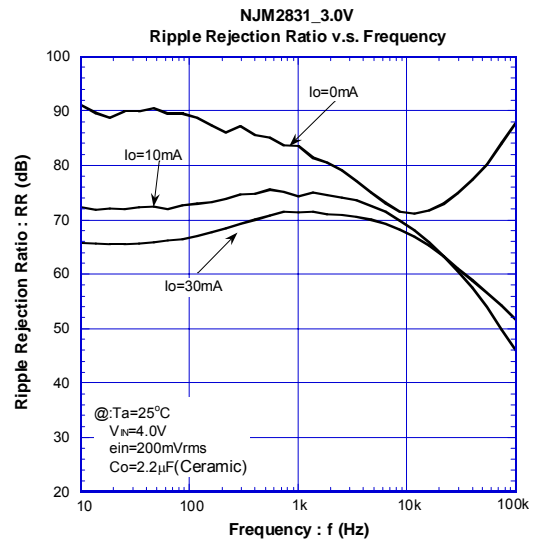
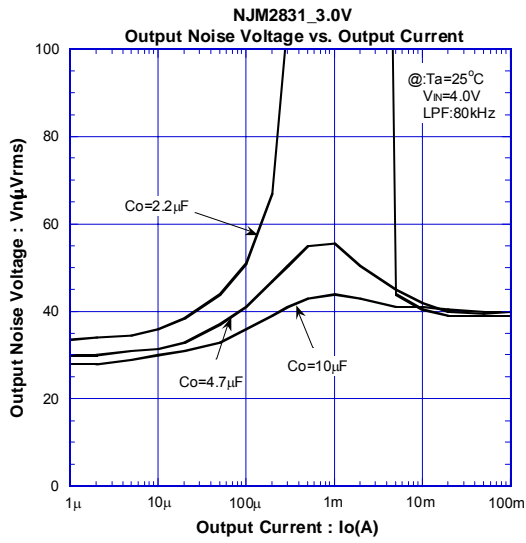

# NJM2831

## ■ TYPICAL CHARACTERISTICS

### ● TEMPERATURE CHARACTERISTICS (3V Version)

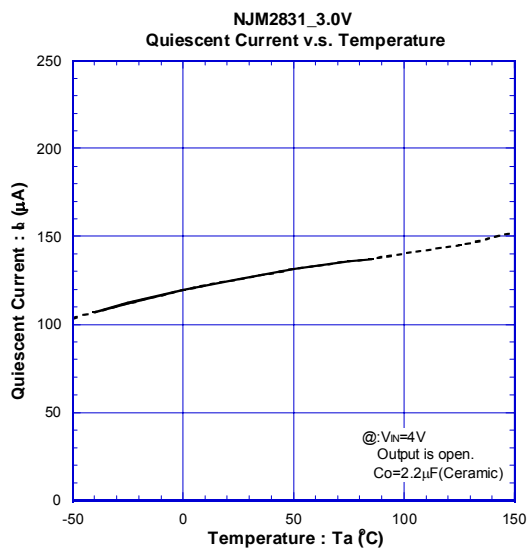
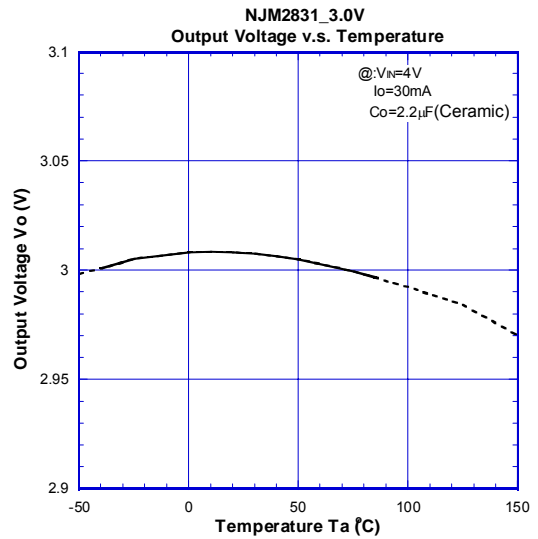
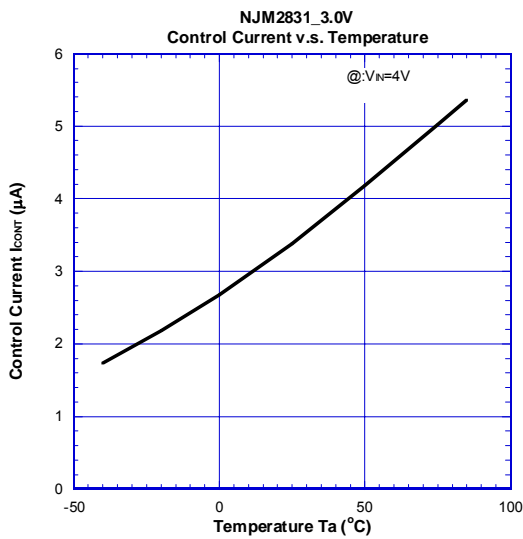
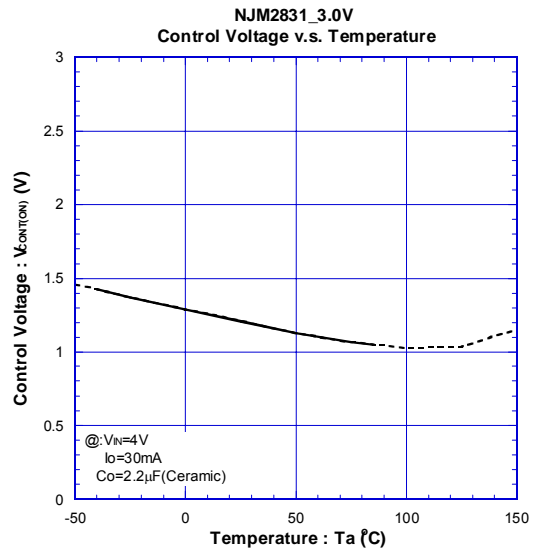
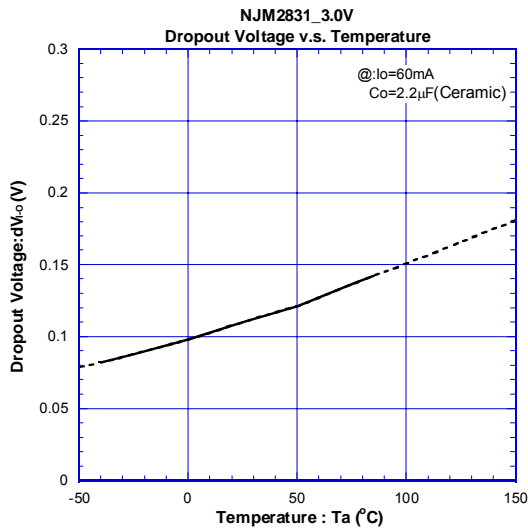

## TYPICAL CHARACTERISTICS

### ● TEMPERATURE CHARACTERISTICS (3V Version)

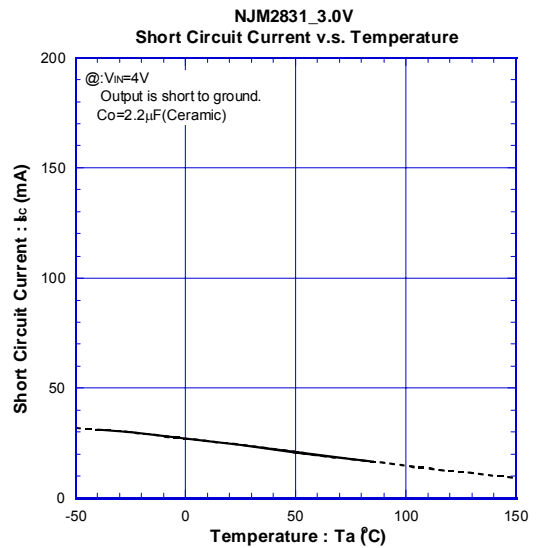
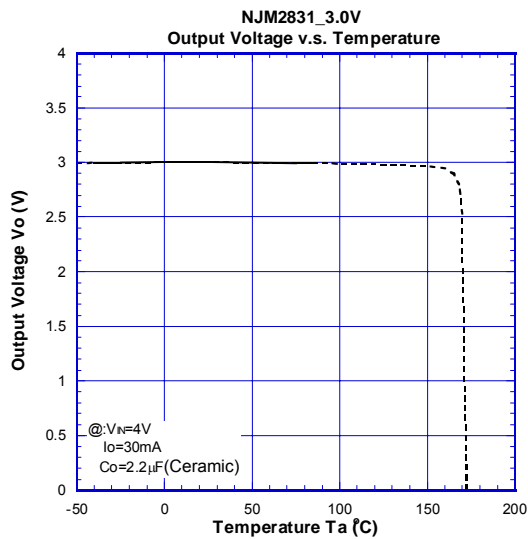
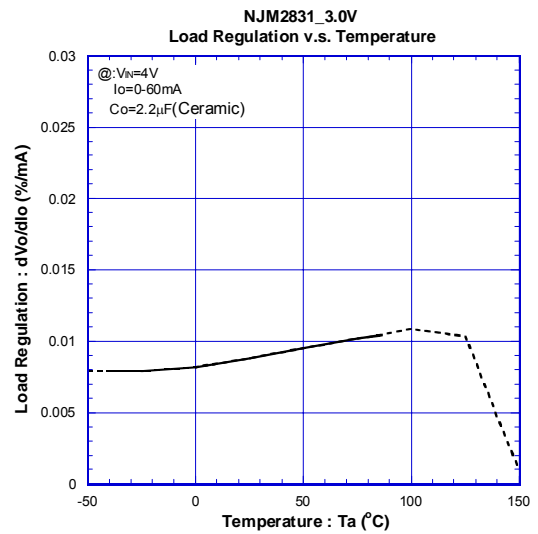
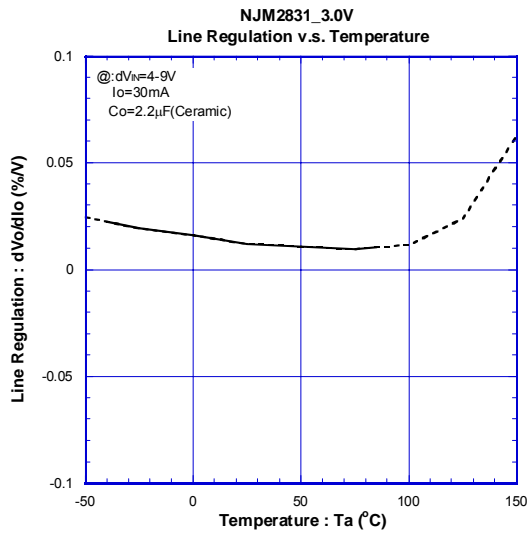

# NJM2831

## TYPICAL CHARACTERISTICS

### TRANSIENT RESPONSE (3V Version)

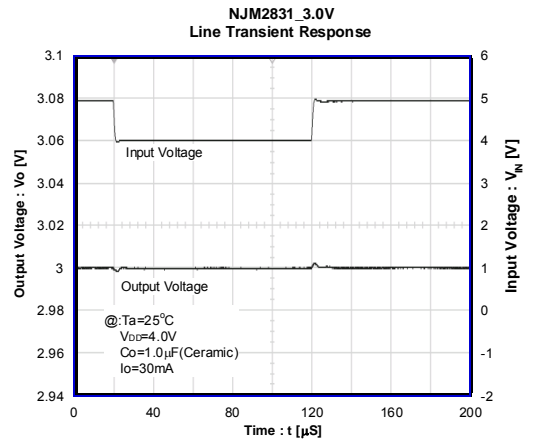
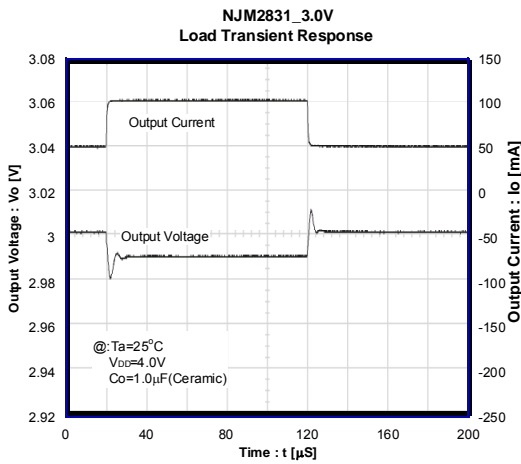
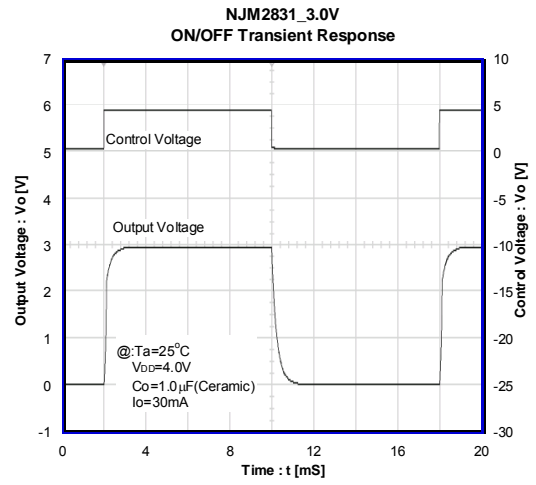
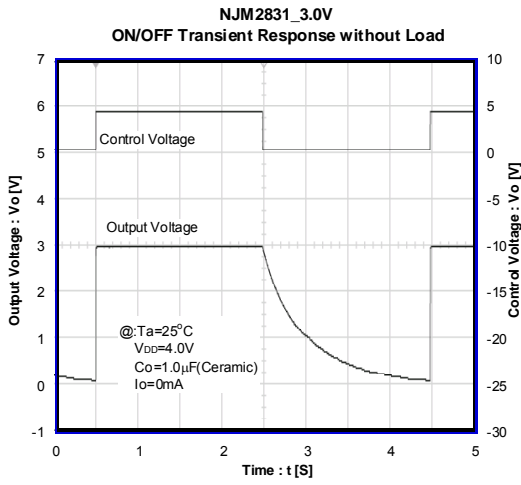

## TYPICAL CHARACTERISTICS

### DC CHARACTERISTICS (8.5V Version)

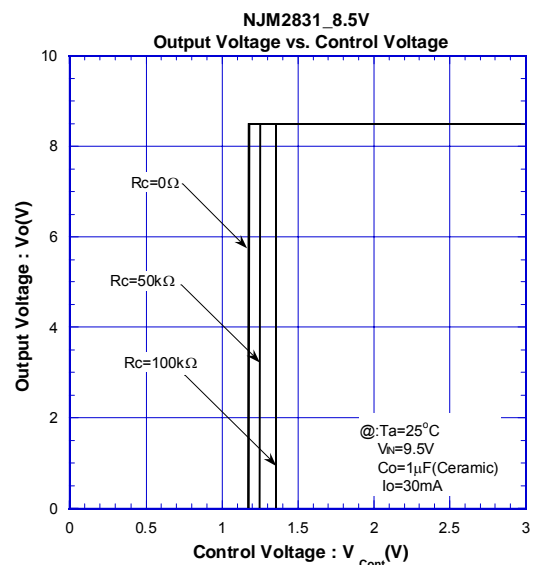
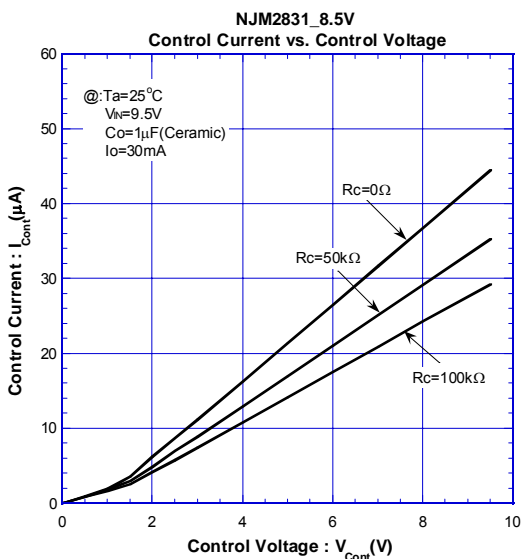
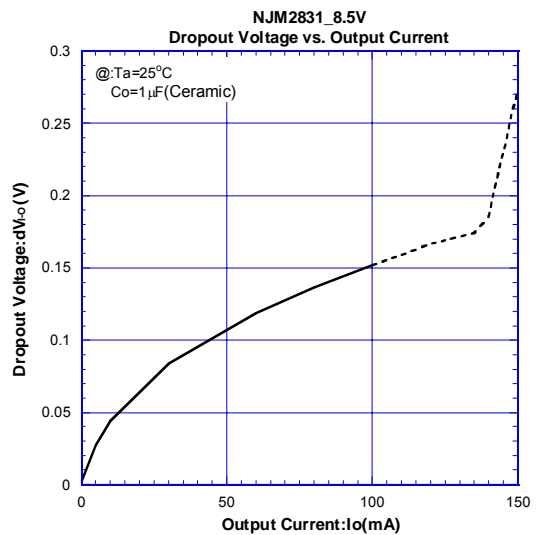
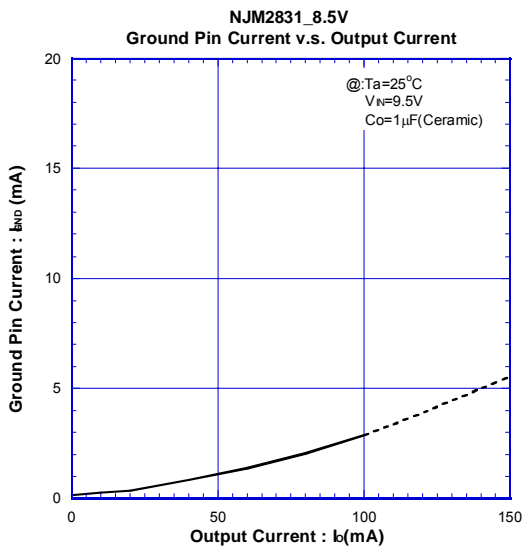
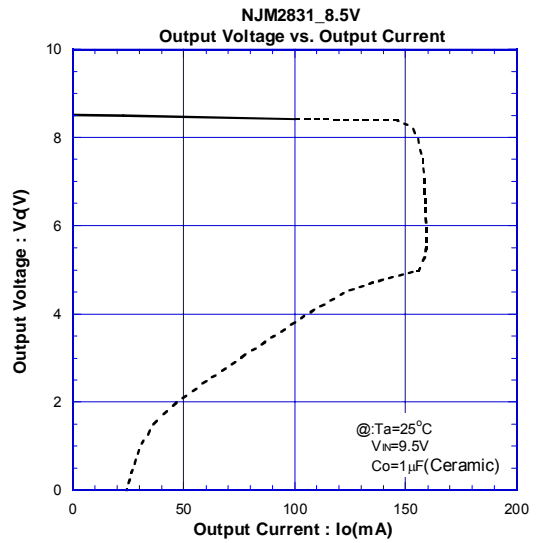
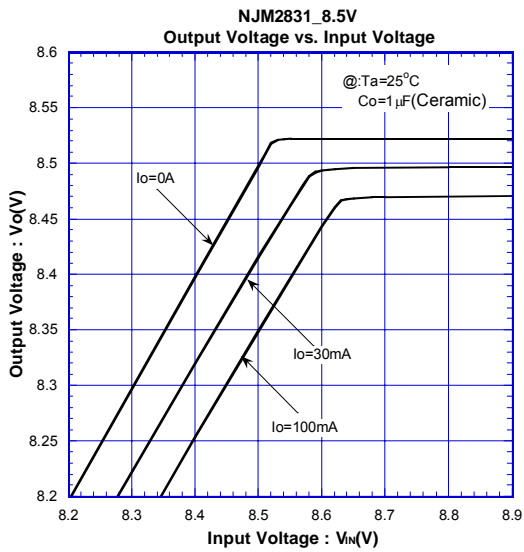

# NJM2831

## ■ TYPICAL CHARACTERISTICS

### ● DC CHARACTERISTICS (8.5V Version)

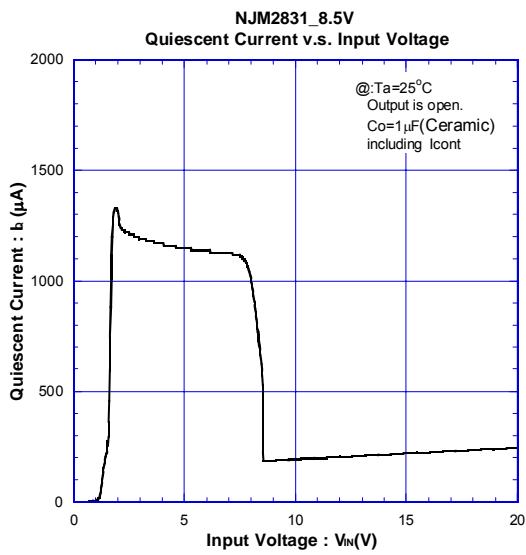
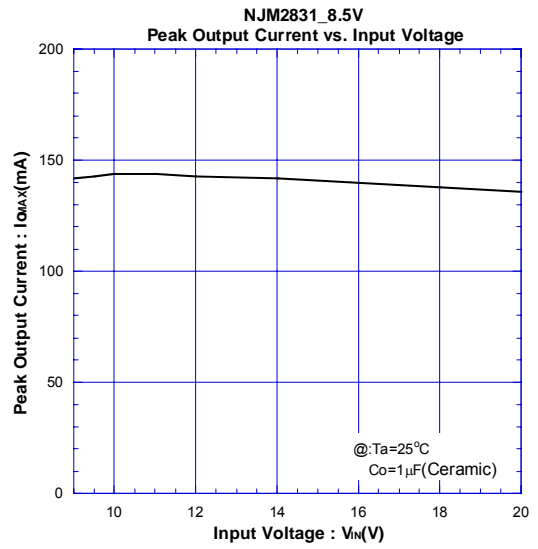
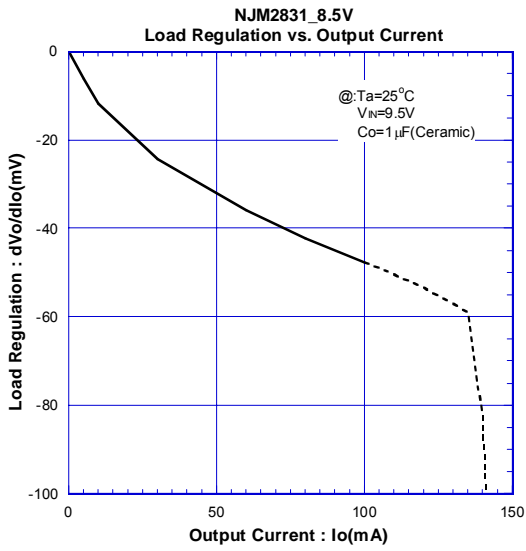

## TYPICAL CHARACTERISTICS

### ●AC CHARACTERISTICS (8.5V Version)

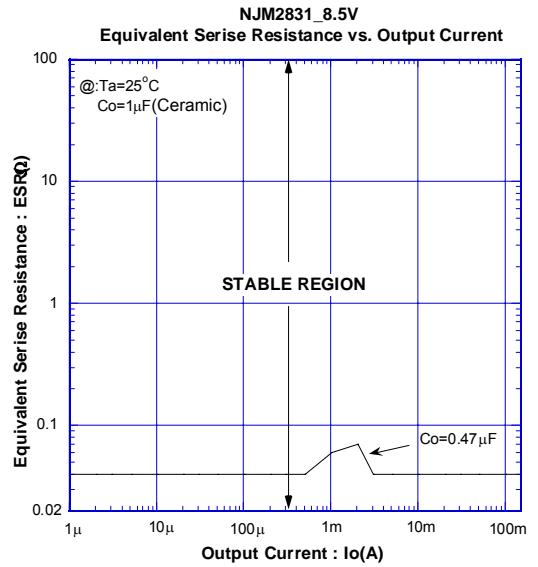
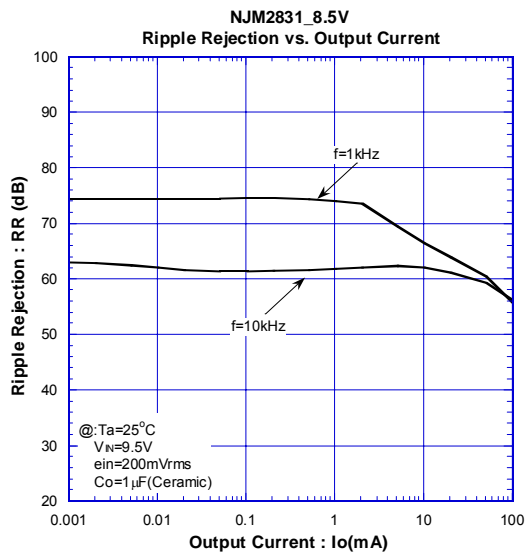
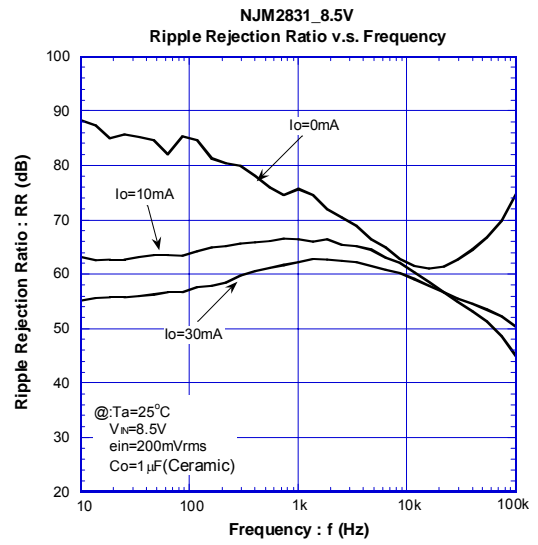
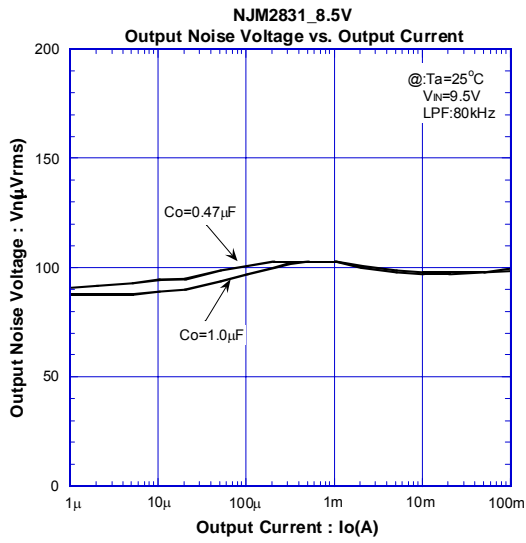

# NJM2831

## ■ TYPICAL CHARACTERISTICS

### ● TEMPERATURE CHARACTERISTICS (8.5V Version)

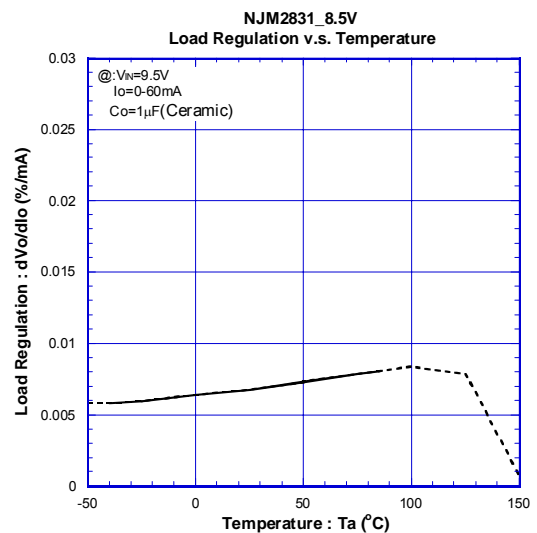
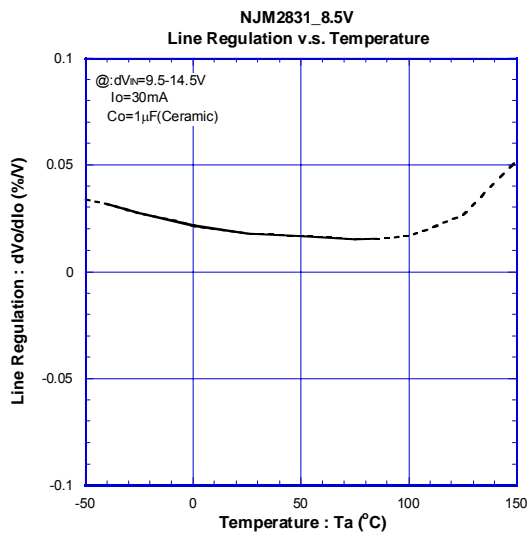
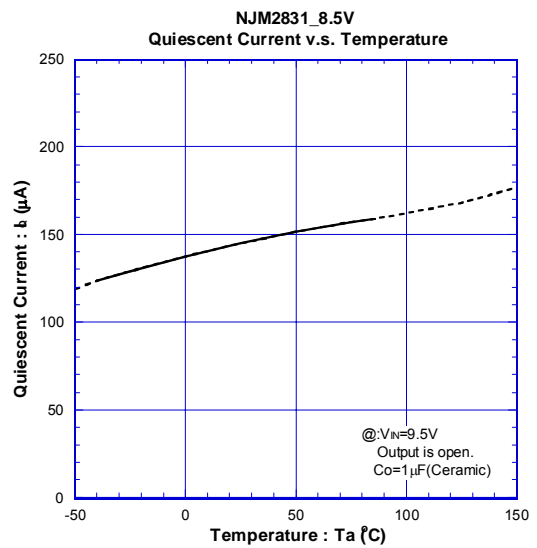
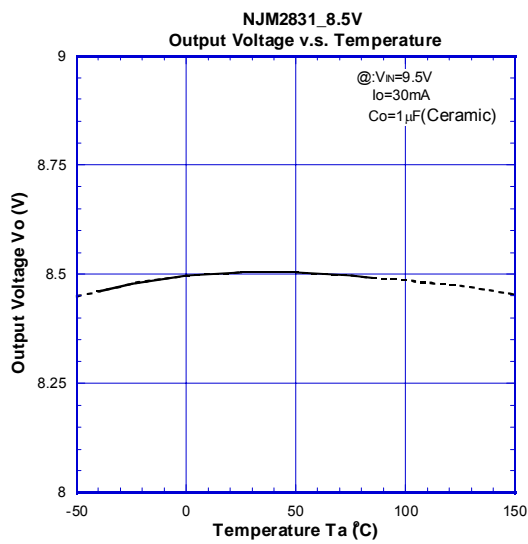
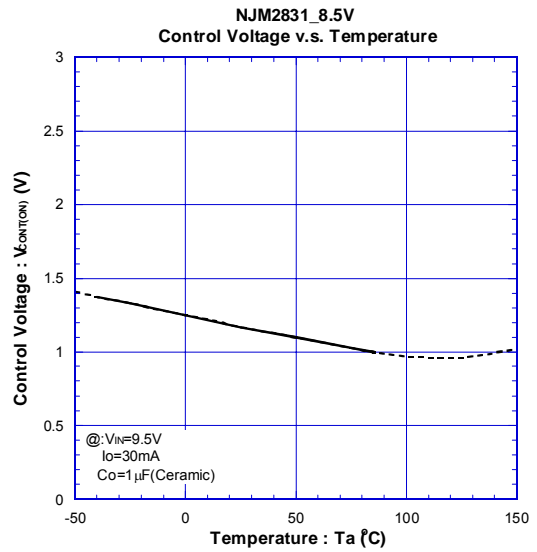
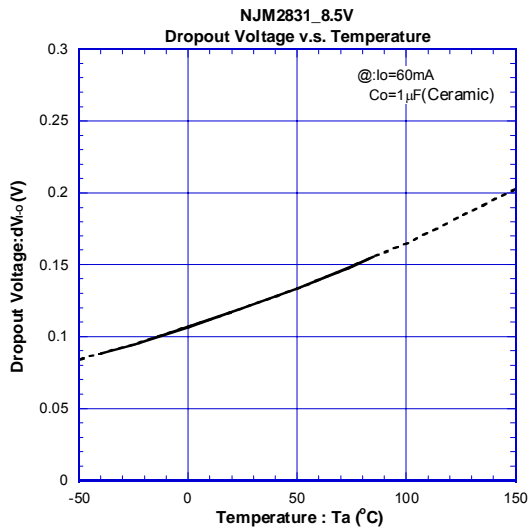



## ■ TYPICAL CHARACTERISTICS

### ● TEMPERATURE CHARACTERISTICS (8.5V Version)

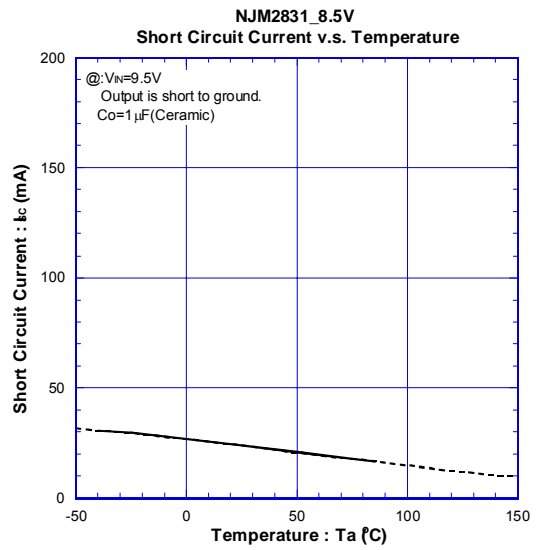
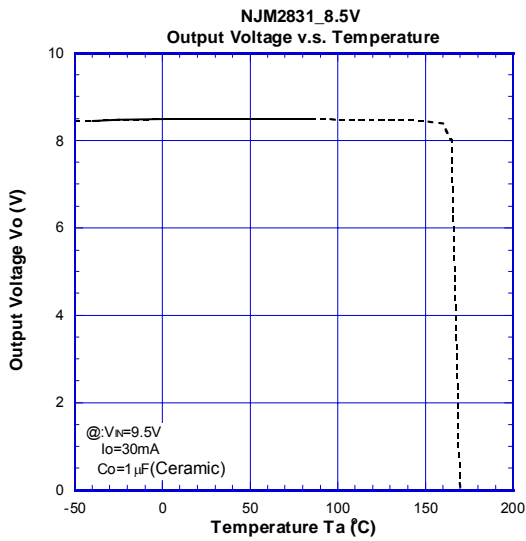

### ● TRANSIENT RESPONSE (8.5V Version)

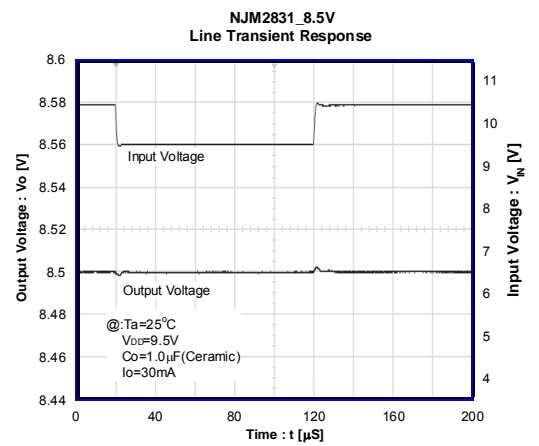
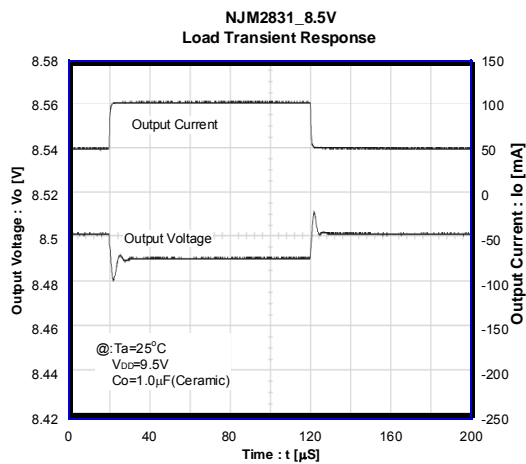
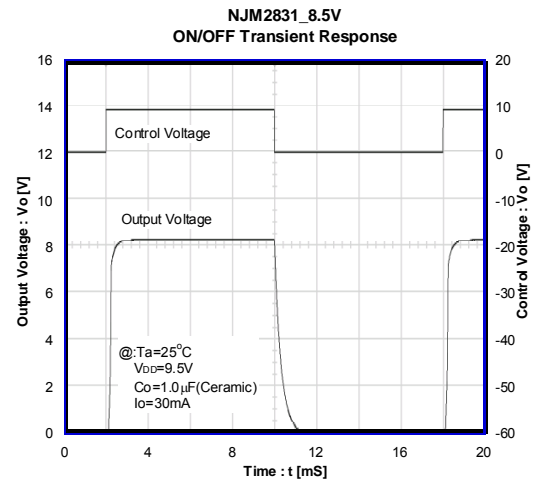
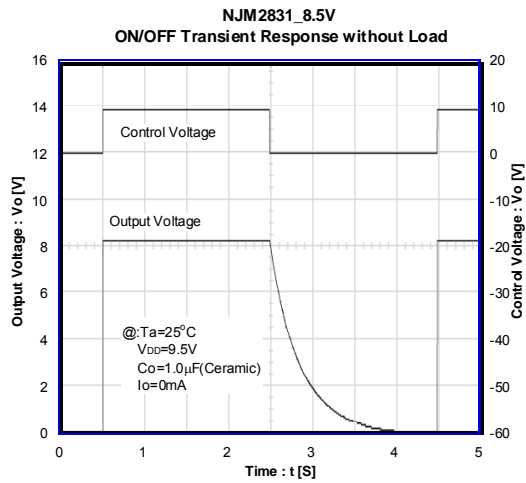

# NJM2831

## ■ TYPICAL CHARACTERISTICS

### ● DC CHARACTERISTICS (15V Version)

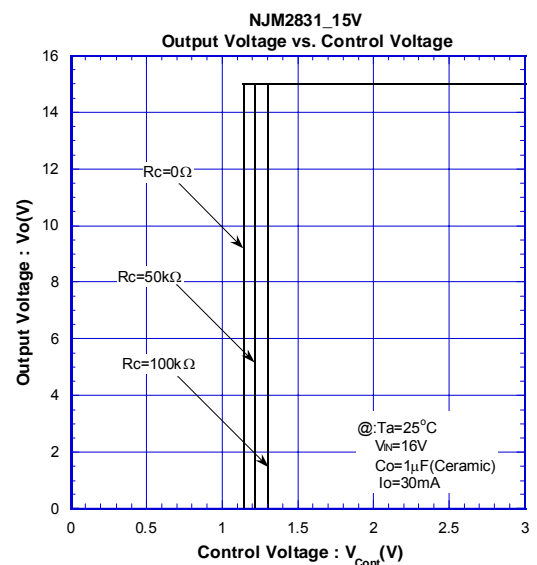
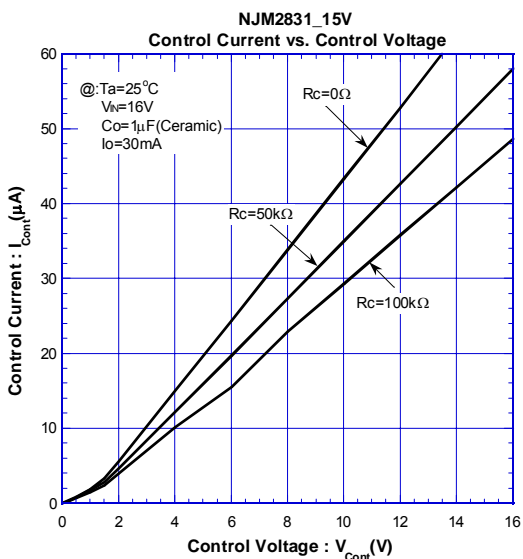
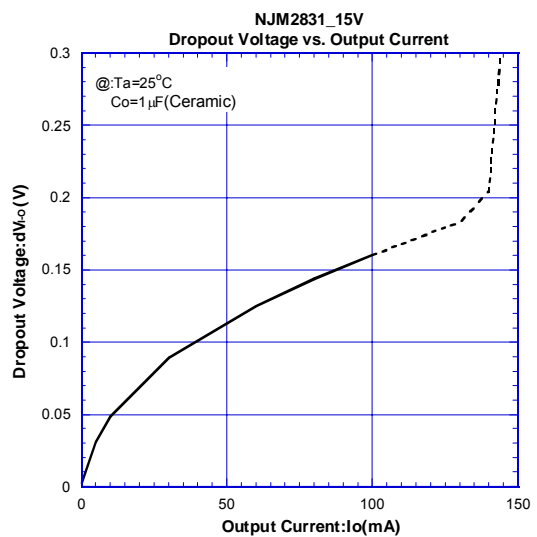
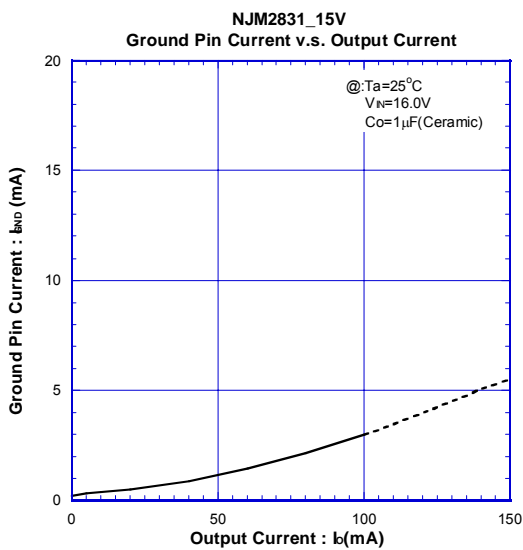
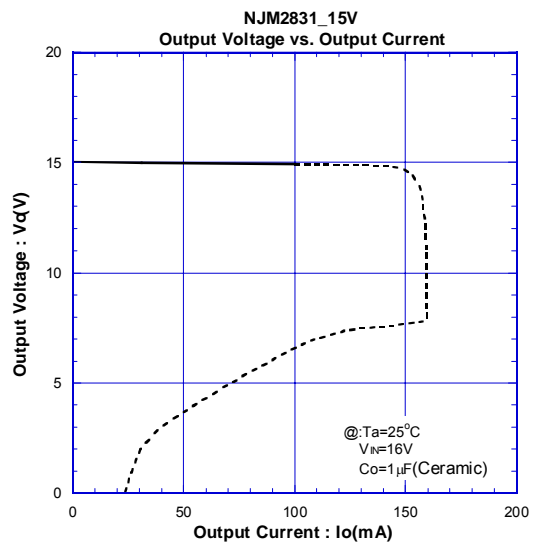
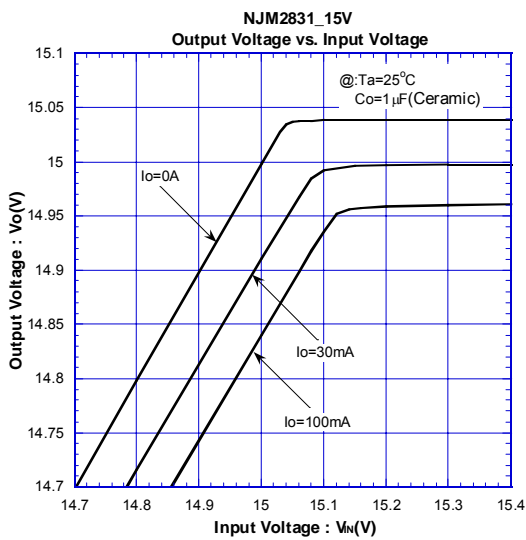

## TYPICAL CHARACTERISTICS

### DC CHARACTERISTICS (15V Version)

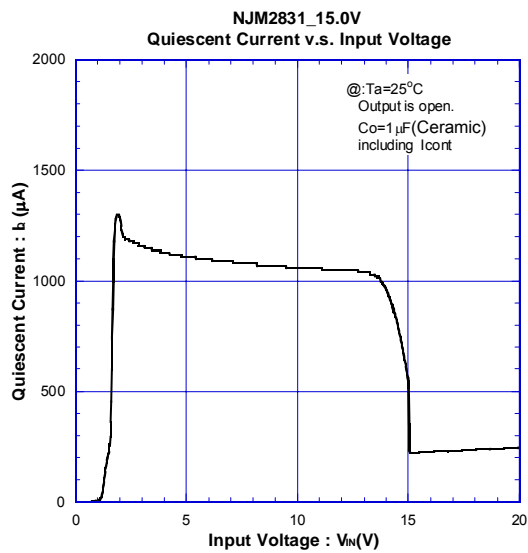
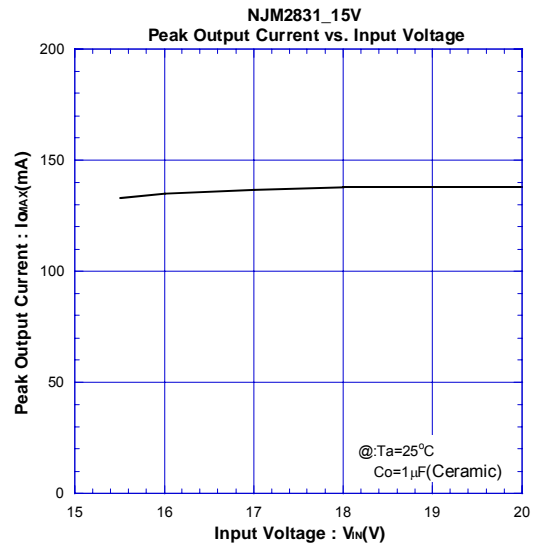
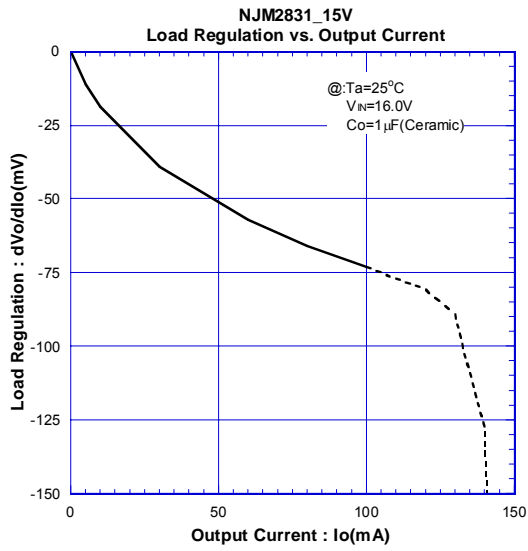

# NJM2831

## TYPICAL CHARACTERISTICS

### AC CHARACTERISTICS (15V Version)

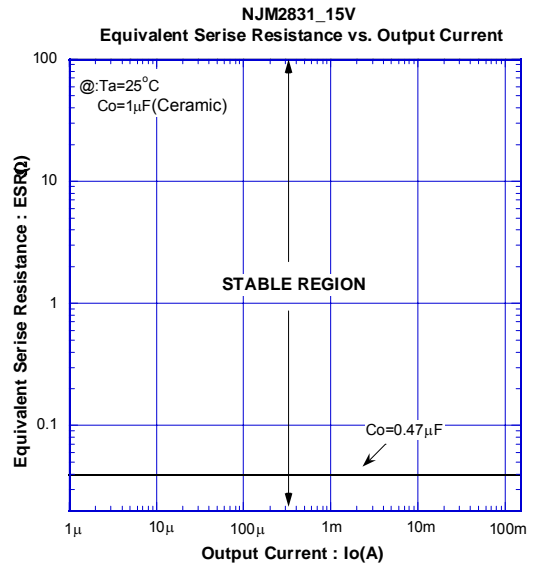
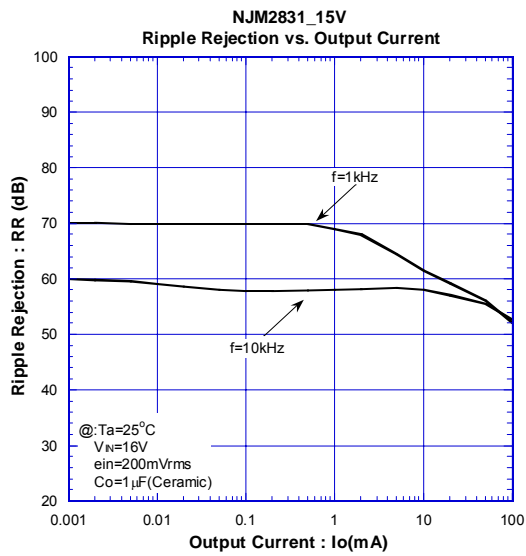
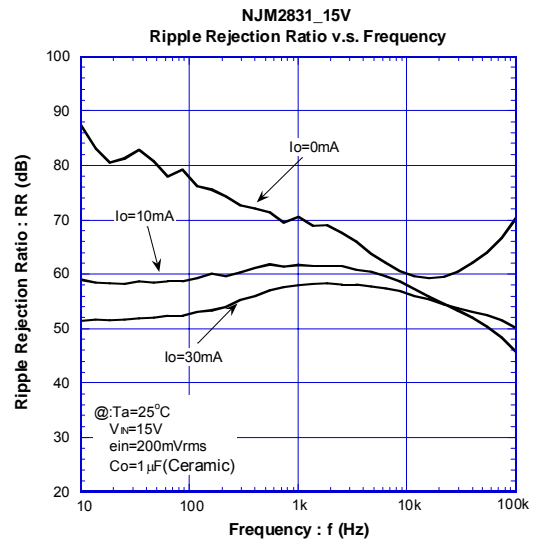
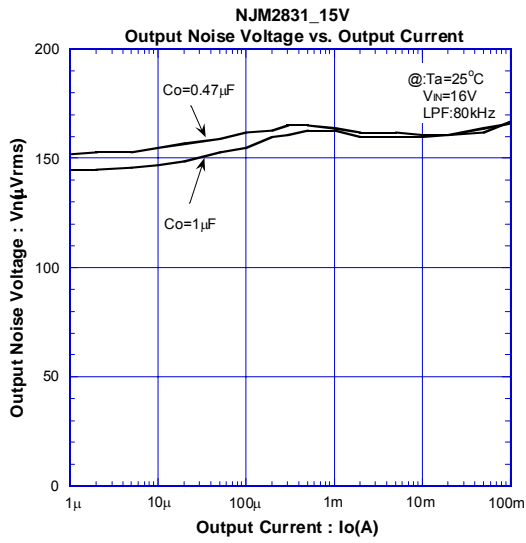

## ■ TYPICAL CHARACTERISTICS

### ● TEMPERATURE CHARACTERISTICS (15V Version)

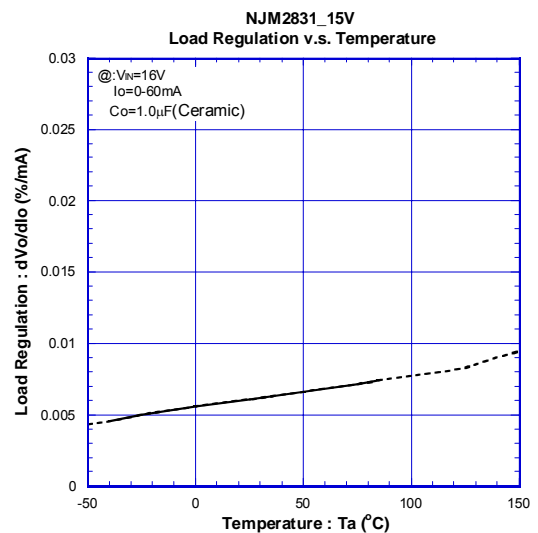
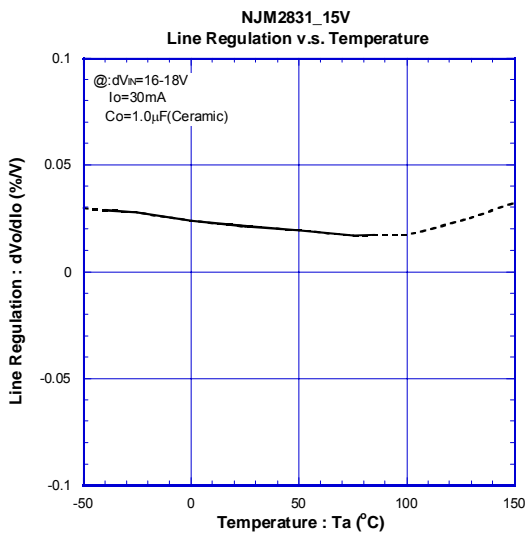
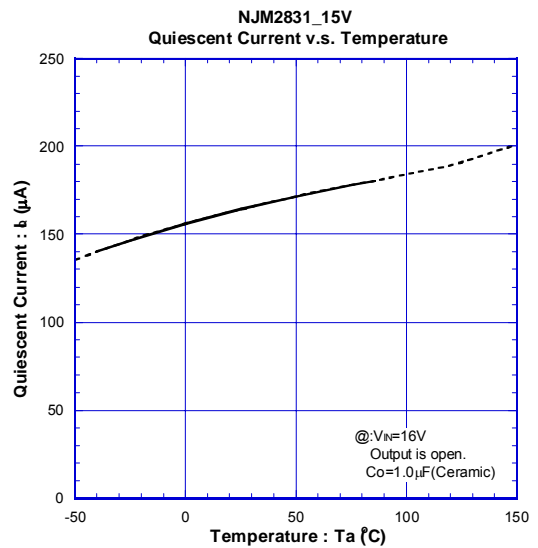
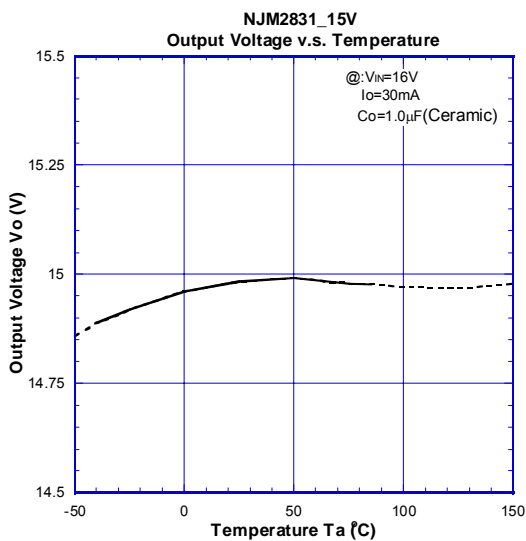
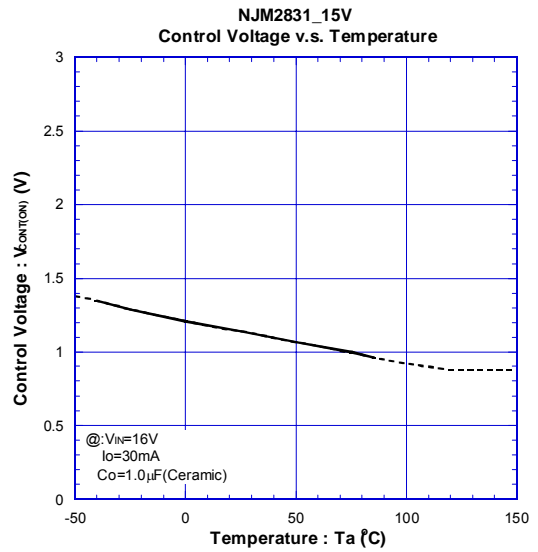
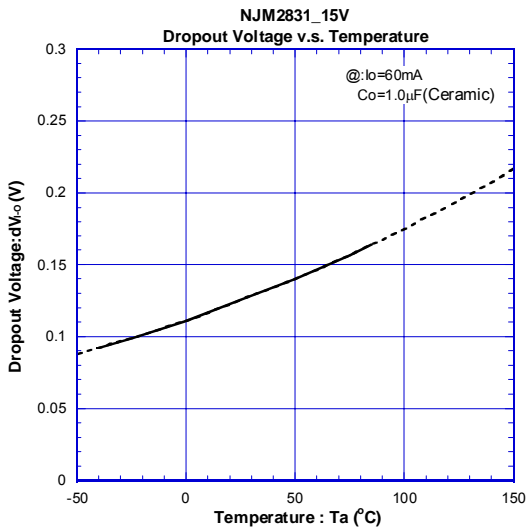

# NJM2831

## ■ TYPICAL CHARACTERISTICS

### ● TEMPERATURE CHARACTERISTICS (15V Version)

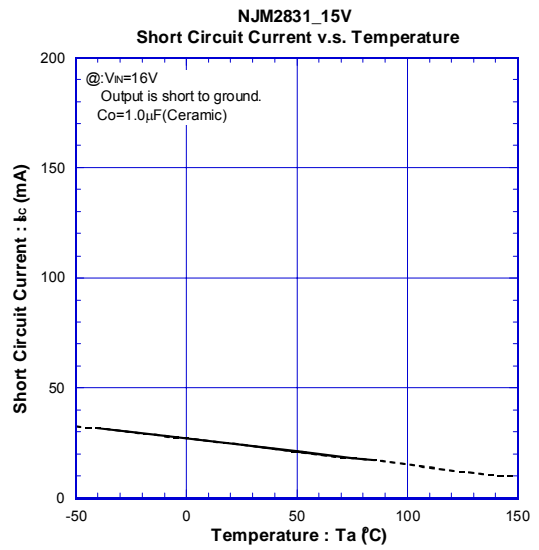
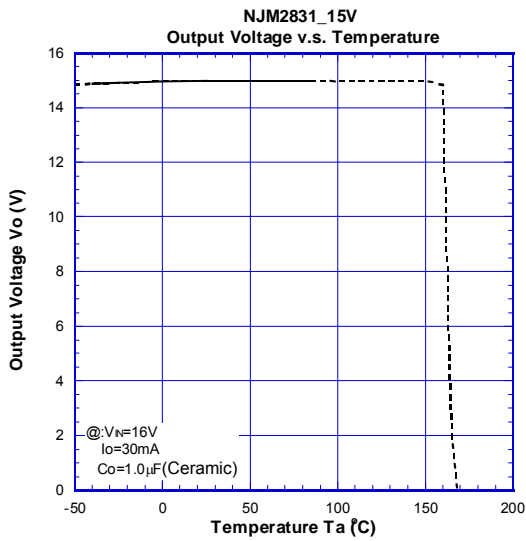

### ● TRANSIENT RESPONSE (15V Version)

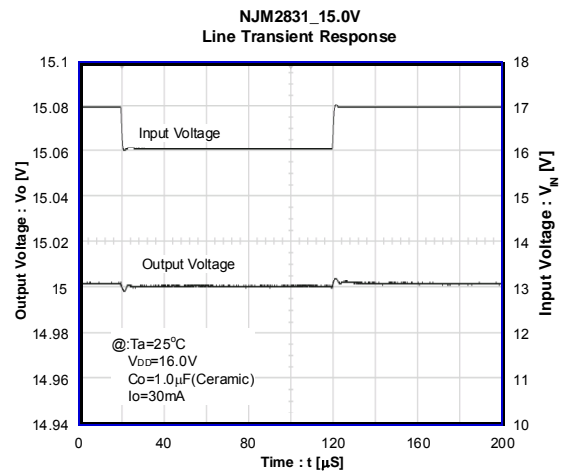
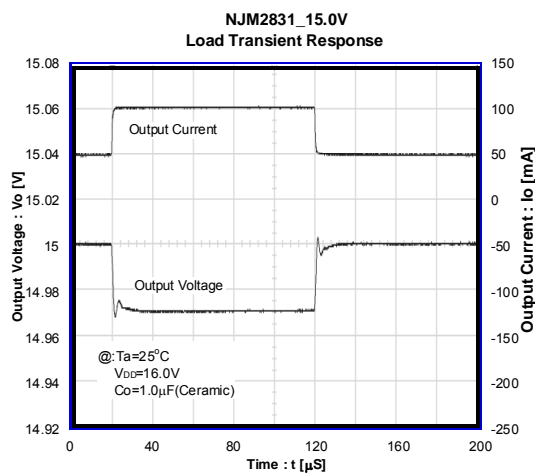
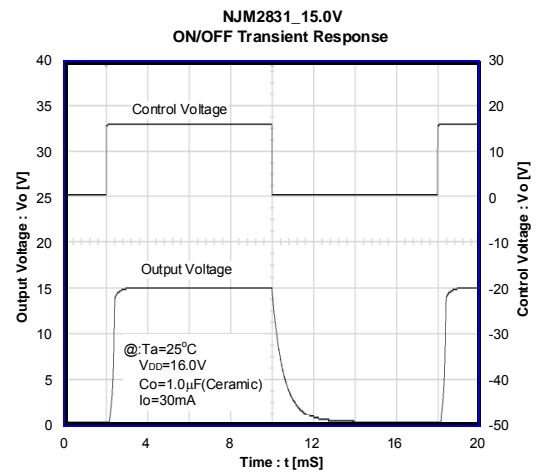
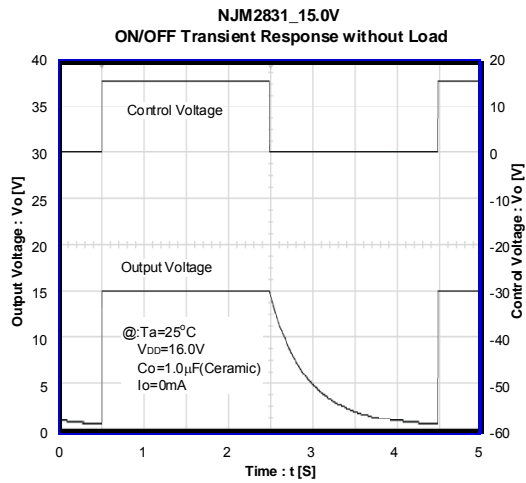

**[CAUTION]**

The specifications on this databook are only given for information, without any guarantee as regards either mistakes or omissions. The application circuits in this databook are described only to show representative usages of the product and not intended for the guarantee or permission of any right including the industrial rights.