

SPECIFICATION FOR APPROVAL

REF. :

PROD. NAME	High Current Multilayer Chip Bead	ABC'S DWG NO.		MB□□□□□□□□Lo-□□□	
		REV.	20150427-G	PAGE	1

I . Configuration and dimensions :

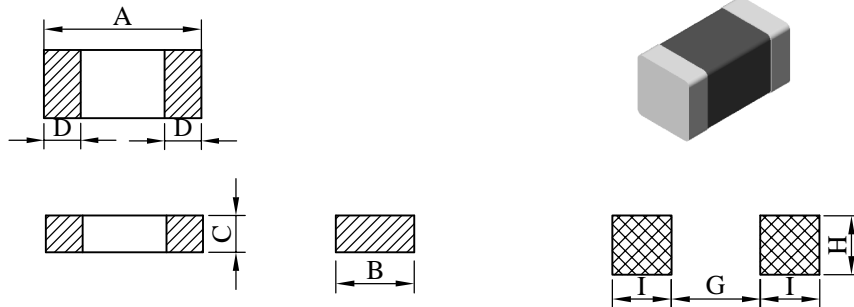

(PCB Pattern)

Unit : m/m

Series	A	B	C	D	G	H	I
MB2029	2.0 ± 0.2	1.2 ± 0.2	0.9 ± 0.2	0.5 ± 0.3	0.8	1.0	1.0
MB1608	1.6 ± 0.2	0.8 ± 0.2	0.8 ± 0.2	0.3 ± 0.2	0.7	0.7	0.7

II . Materials :

- a . Body : Ferrite
- b . Internal conductor : Silver
- c . Terminal electrode : Ag / Ni / Sn
- d . Product weight : 10.0 (2029) / 5.4 (1608) mg (ref.)
- e . Products comply with RoHS' requirements
- f . Halogen free available.

III . General specification :

a . Storage Conditions :

Electrical Performance temp : -55°C ---- +125°C

Terminal Solderability & Packages Material temp : -10°C ---- +40°C and RH 70% max.

b . Operating temp. : -55°C ---- +125°C

c . Terminal strength :

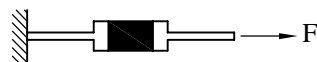

Type	F (kgf)	Time (sec)
MB2029	0.6	30±5
MB1608	0.5	

d . Resistance to soldering heat :

Solder temp. : 260°C
Dip time : 10 sec max.

Peak Temp : 260°C max.
Max. Peak Temp - 5°C : 30sec max.
Max time above 217°C : 60sec~150sec max.

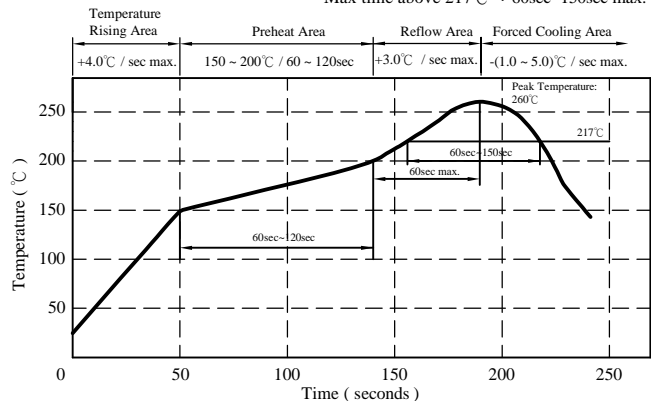

AR-001C

SPECIFICATION FOR APPROVAL

REF. :

PROD. NAME	High Current Multilayer Chip Bead	ABC'S DWG NO.	MB□□□□□□□□L□-□□□		
		REV.	20150427-G	PAGE	2

IV . Electrical characteristics :

DWG No.	Impedance (Ω) at 100MHz	RDC (mΩ) max.	IDC (A) max.
MB2029070YL□-□□□	7±25%	30	3.0
MB2029100YL□-□□□	10±25%	30	3.0
MB2029300YL□-□□□	30±25%	25	3.0
MB1608300YL□-□□□	30±25%	40	3.0

- 1). □ : Packaging information : □ Code
- 2). "- □□□ " : Reference code
- 3). Electrical specifications at 25°C

MB2029070YL□

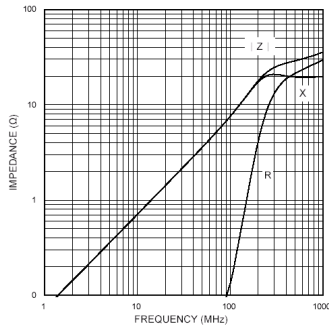

MB2029100YL□

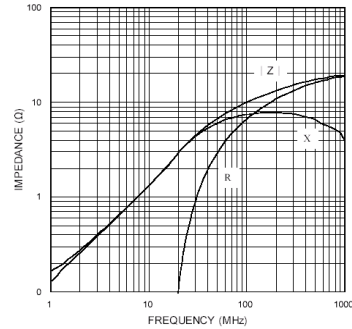

MB2029300YL□

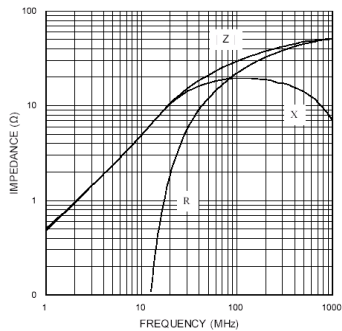

MB1608300YL□

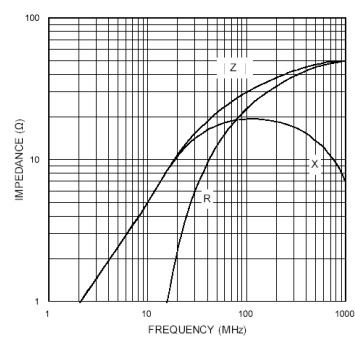

AR-001C

SPECIFICATION FOR APPROVAL

REF. :

PROD. NAME	High Current Multilayer Chip Bead	ABC'S DWG NO.		MB□□□□□□□□Lo-□□□	
		REV.	20150427-G	PAGE	3

V . Packaging information :

(1) Configuration

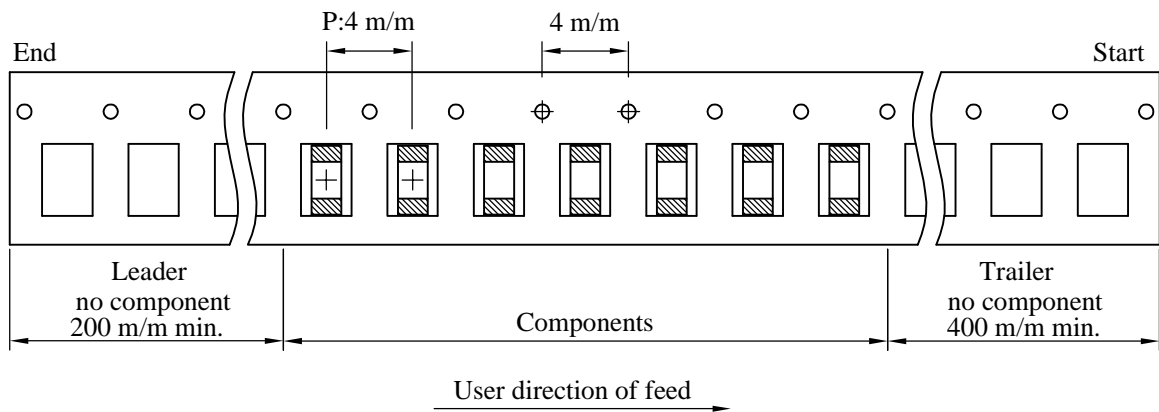
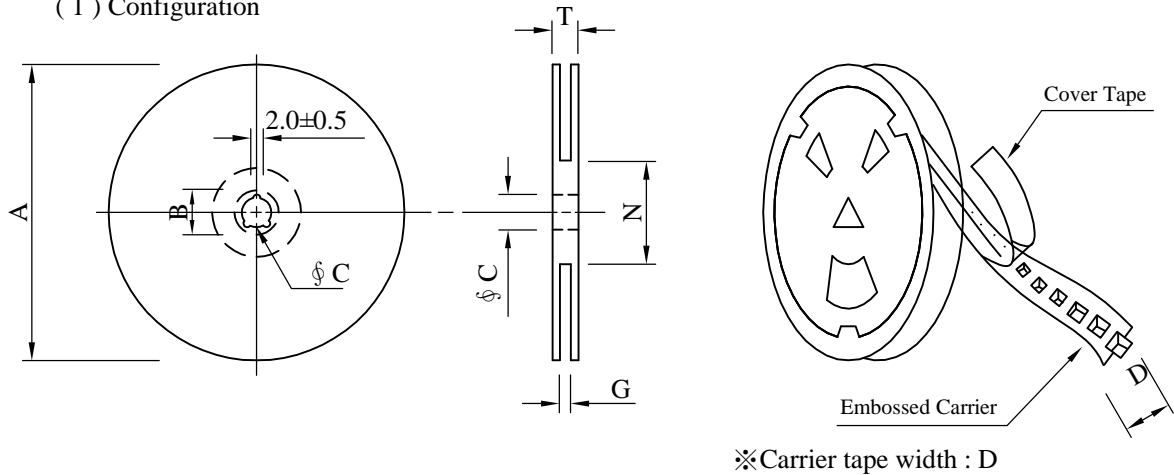

(2) Dimensions

Unit:m/m

Style	A	B	C	D	G	N	T
07 - 08	178	21±0.8	13	8	10 ⁺⁰	50 ⁻⁰	12.5

(3) Q'TY & G.W. Per package

Code	Inner : Reel			Outer : Cartion			
	Q'TY (pcs)	G.W. (gw)	Style	Q'TY(kpcs)	G.W. (Kg)	Size (cm)	
B	MB2029	4,000	120	07 - 08	200	8.5	41 x 39 x 22
	MB1608	4,000	90	07 - 08	200	7.0	41 x 39 x 22

AR-001C

SPECIFICATION FOR APPROVAL

REF. :

PROD. NAME	High Current Multilayer Chip Bead	ABC'S DWG NO.	MB□□□□□□□□L□-□□□		
		REV.	20150427-G	PAGE	4

VI . Reliability test :

Item	Reference documents	Test Condition	Test Specification
1.High Temperature Exposure	MIL-STD-202 Method 108	1.Temperature: 125°C 2.Time:1008 hours. 3.Measurement : After placing for 24 hours min.	1.Body: No damage 2.Impedance shall not change more than ±30%.
2.Low Temperature Exposure	JESD22-A119	1.Temperature: -55°C 2.Time:1008 hours. 3.Measurement : After placing for 24 hours min.	1.Body: No damage 2.Impedance shall not change more than ±30%.
3.Temperature Cycling	JESD22-A 104	1.Temperature: -55°C ~ 125°C 2.Number of cycle:100 cycle 3.Dwell time:30 minutes 4.Measurement : After placing for 24 hours min.	1.Body: No damage 2.Impedance shall not change more than ±30%.
4.Biased Humidity Test	MIL-STD-202 Method 103	1.Temperature:40±5 °C 2.Time:1008 Hours 3.Humidity: 95% RH. 4.Measurement : After placing for 24 hours min.	1.Body: No damage 2.Impedance shall not change more than ±30%.
5.Vibration Test	MIL-STD-202 Method 204	1.Frequency and Amplitued : 10-55-10 Hz, 1.5 mm. 2.Direction:X, Y, Z 3.Test duration:2 hours for each direction, 6 hours in total.	Appearance: No damage
6.Resistance To Soldering Heat Test	MIL-STD-202 Method 210	1.Solder Temp. : 265±3°C 2.Immersion time : 6±1 sec 3.Preheating : 100°C to 150°C, 1 minute. 4.Measurement : After placing for 24 hours min.	1.Appearance: No damage 2.Impedance shall not change more than ±30%.
7.Solderability Test	J-STD-002	1.Preheat : 150°C,60 seconds 2.Solder temperature : 245±5°C 3.Flux 4.Dip time : 4±1 seconds	The terminal shall be at least 90% covered with fresh solder.
8.Terminal Strength Test	IEC 60068-2-21	1.Apply push force to samples mounted on PCB. 2.Force: Refer to product specification. 3.Dwell time : >25 seconds.	The terminal electrode and the body shall not be damaged by the forces applied on the right conditions.
9.Board Flex	JIS-C-6429	1.Deflection speed : 1 mm/ sec 2.Amount of deflection : 2 mm 3.Span : 90 mm 4.Direction for test : Bottom of PCB 5.Holding time : 60 seconds.	1.Appearance: No damage 2.The terminal electrode and the body shall not be damaged by the forces applied on the right conditions.

AR-001C