

**Features**

1. Opaque type, mini-flat package.
2. Subminiature type  
(The volume is smaller than that of our conventional DIP type by as far as 30%)
3. Isolation voltage between input and output (Viso:2500Vrms).

**For 115/240 Vac (rms) Application:**

1. Solenoid/Valve Controls.
2. Lighting Controls.
3. Static Power Switches.
4. AC Motor Drives.
5. Temperature Controls.
6. E.M. Contactors.
7. AC Motor Staters.
8. Solid State Relays.
9. Programmable controllers.

**Outside Dimension:Unit (mm)**

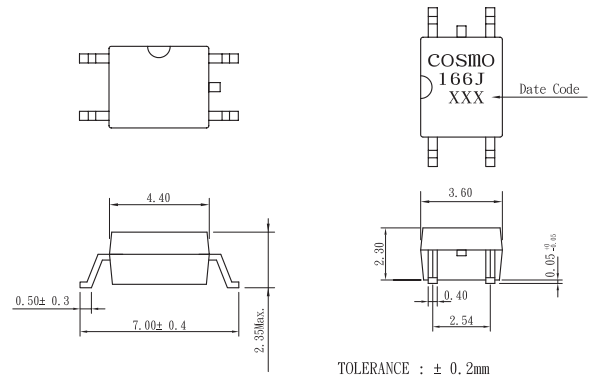

**Schematic:Top View**

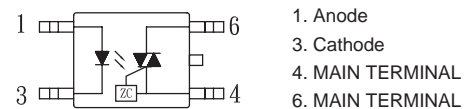

**Absolute Maximum Ratings**

(Ta=25°C)

Parameter	Symbol	Rating	Unit
Input	Forward current	IF	50 mA
	Peak forward current (100us)	IFM	1 A
	Reverse voltage	VR	6 V
	Power dissipation	PD	70 mW
Output	Off-State Output Terminal voltage	VDRM	600 Vpeak
	On-State R. M. S. Current	IT(RMS)	70 mA
	Peak Repetitive Surget Current (PW=10ms, DC 10%)	ITSM	1 A
	Power dissipation	PD	150 mW
Total power dissipation	Ptot	200 mW	
Isolation voltage 1 minute	Viso	2500	Vrms
Operating temperature	Topr	-40 to +100	°C
Storage temperature	Tstg	-50 to +125	°C
Soldering temperature 10 second	Tsol	260	°C

**Electro-optical Characteristics**

(Ta=25°C)

Parameter	Symbol	Conditions	MIN.	TYP.	MAX.	Unit	
Input	Forward voltage	IF=10mA		1.2	1.4	V	
	Peak forward voltage	IFM=0.5A			3.5	V	
	Reverse Leakage Current	VR=5V			10	µA	
Output	Peak Blocking Current	VDRM=600V			1.0	nA	
	ON-State Voltage	ITM=70mA		1.6	2.8	V	
Transfer characteristics	Holding Current			1.0		mA	
	Critical rate of rise of OFF-state voltage	VDRM= (1/ 2) *Rated	600	旻		V/ µS	
	Isolation resistance	DC500V	5x10 <sup>10</sup>	10 <sup>11</sup>		ohm	
	Minimum trigger current	Main Terminal Voltage=3V		5	10	mA	
	Inhibit Voltage (MT2 Voltage above which device not trigger.)	IF=Rated IFT				50	V
	Leakage in Inhibited State	IF=Rated IFT, VT=Rated VDRM		旻		600	µA

Classification table of Trigger LED current is shown below.

( $T_a=25^{\circ}\text{C}$ )

Classification	Trigger LED Current (mA)	
	Min.	Max.
1 (Standard)	-	10
2	-	7
3	-	5

**Fig.1** Forward Current vs. Ambient Temperature

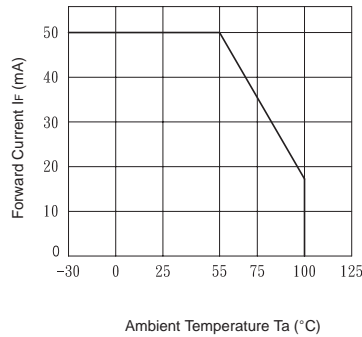

**Fig.2** Diode Power Dissipation vs. Ambient Temperature

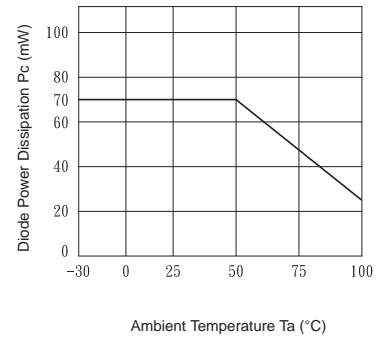

**Fig.3** On-State R. M. S. Current vs. Ambient Temperature

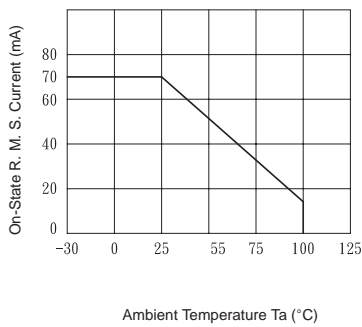

**Fig.4** Total Power Dissipation vs. Ambient Temperature

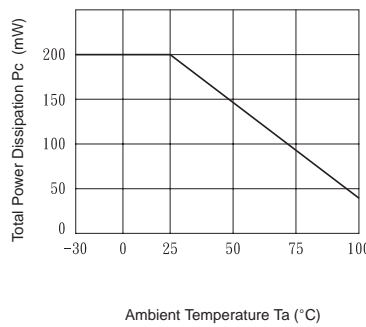

**Fig.5** Peak Forward Current vs. Duty Ratio

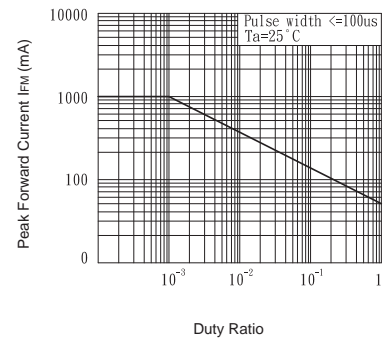

**Fig.6** Forward Current vs. Forward Voltage

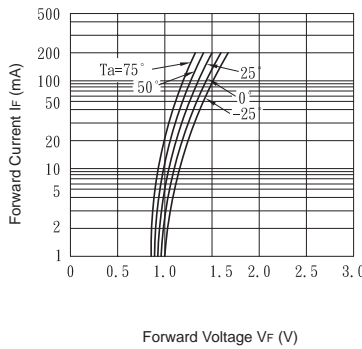

**Fig.7** On-State Characteristics

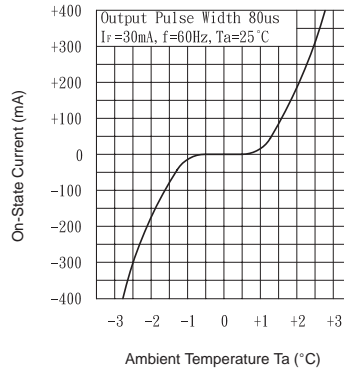

**Fig.8** Leakage with LED off vs. Ambient Temperature

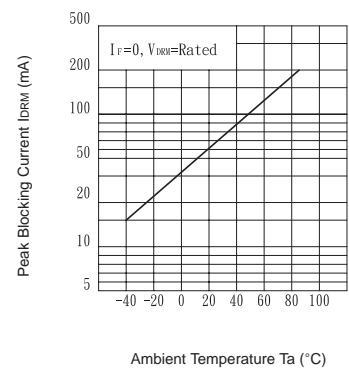

**Fig.9** Trigger Current vs. Ambient Temperature

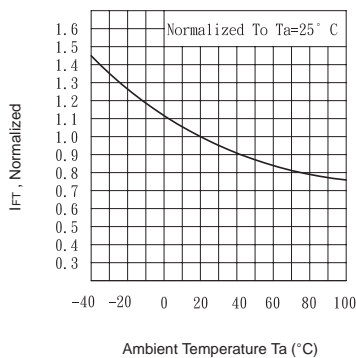

**Fig.10** Inhibit Voltage vs. Ambient Temperature

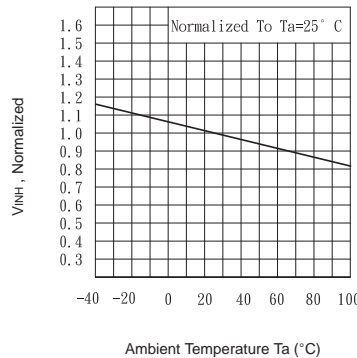

**Fig.11** I\_DRM2, Leakage in Inhibit vs. Ambient Temperature

