

PRODUCT SPECIFICATION

DATE:09/21/2006

cosmo ELECTRONICS CORPORATION	Photocoupler : KP1210	NO.60P00036	REV. 3
		SHEET 1 OF 6	

High Reliability Photocoupler

●Features

- 1.Current transfer ratio (CTR : 50~600% at $I_F=5mA$ $V_{ce}=5V$)
- 2.High isolation voltage between input and output (Viso : 5000Vrms).
- 3.Compact dual-in-line package.

●Applications

1. Registers, copiers, automatic vending machines.
2. System appliances, measuring instruments.
3. Computer terminals, programmable controllers.
4. Communications, telephone, etc.
5. Electric home appliances, such as oil fan heaters, Microwave oven , Washer, Refrigerator, Air conditioner, etc.
6. Medical instruments, physical and chemical equipment.
7. Signal transmission between circuits of different potentials and impedances.
8. Facsimile equipment, Audio, Video
9. Switching power supply, Laser beam printer.

PRODUCT SPECIFICATION

DATE: 09/21/2006

cosmo ELECTRONICS CORPORATION	Photocoupler : KP1210	NO.60P00036	REV. 3
		SHEET 2 OF 6	

1. OUTSIDE DIMENSION : UNIT (mm)

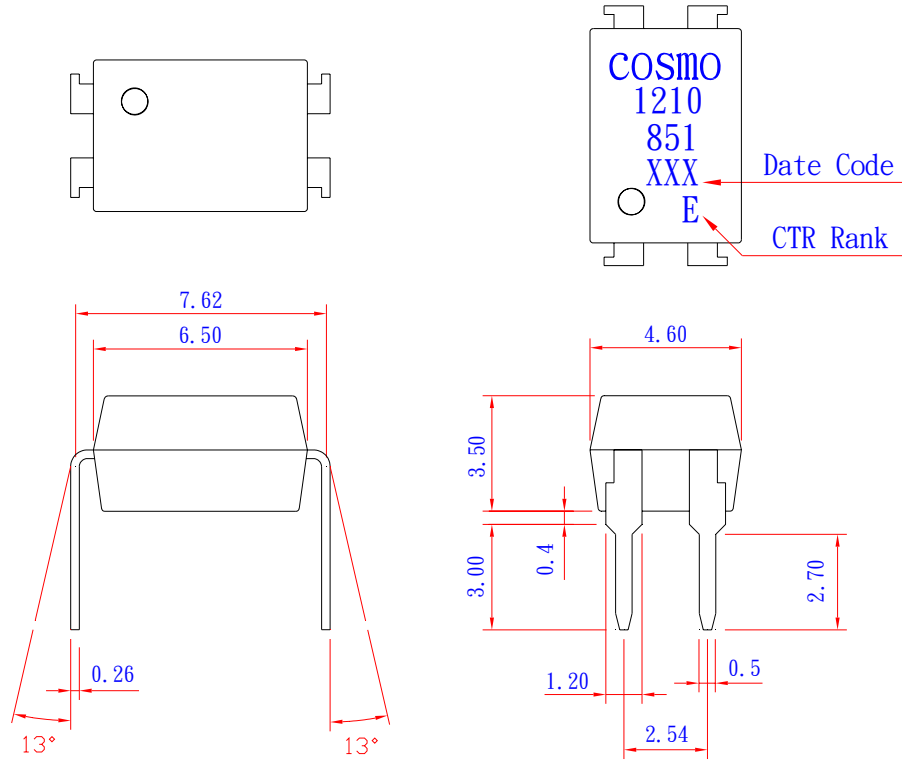

TOLERANCE : $\pm 0.2\text{mm}$

2. SCHEMATIC : TOP VIEW

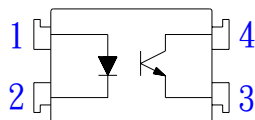

1. Anode
2. Cathode
3. Emitter
4. Collector

PRODUCT SPECIFICATION

DATE: 09/21/2006

cosmo ELECTRONICS CORPORATION	Photocoupler : KP1210	NO.60P00036	REV. 3
		SHEET 3 OF 6	

●Absolute Maximum Ratings

	Parameter	Symbol	Rating	Unit
Input	Forward current	I_F	50	mA
	Peak forward current	I_{FM}	1	A
	Reverse voltage	V_R	6	V
	Power dissipation	P_D	70	mW
Output	Collector-emitter voltage	V_{CEO}	350	V
	Emitter-collector voltage	V_{ECO}	7	V
	Collector current	I_C	50	mA
	Collector power dissipation	P_C	150	mW
	Total power dissipation	P_{tot}	200	mW
	Isolation voltage 1 minute	V_{iso}	5000	V_{rms}
	Operating temperature	T_{opr}	-30 to +115	°C
	Storage temperature	T_{sta}	-55 to +125	°C
	Soldering temperature 10 second	T_{sol}	260	°C

●Electro-optical Characteristics

	Parameter	Symbol	Conditions	MIN.	TYP.	MAX.	Unit
Input	Forward voltage	V_F	$I_F=10mA$	1.0	1.2	1.3	V
	Peak forward voltage	V_{FM}	$I_{FM}=0.5A$	-	-	3.0	V
	Reverse current	I_R	$V_R=5V$	-	-	10	uA
	Terminal capacitance	C_t	$V=0, f=1MHz$	-	30	-	pF
Output	Collector dark current	I_{CEO}	$V_{CE}=300V$	-	10	200	nA
Transfer characteristics	Current transfer ratio	CTR	$I_F=5mA, V_{CE}=5V$	50	-	600	%
	Collector-emitter saturation voltage	$V_{CE(sat)}$	$I_F=8mA, I_C=2.4mA$	-	-	0.4	V
	Isolation resistance	R_{iso}	DC500V	5×10^{10}	10^{11}	-	ohm
	Floating capacitance	C_f	$V=0, f=1MHz$	-	0.6	1.0	pF
	Cut-off frequency	f_c	$V_{CC}=5V, I_C=2mA, R_L=100ohm$	-	80	-	kHz
	Response time (Rise)	t_r	$V_{CC}=10V, I_C=2mA, R_L=100ohm$	-	2	-	us
	Response time (Fall)	t_f		-	3	-	us

Fig. 1 Current Transfer Ratio Vs. Forward Current

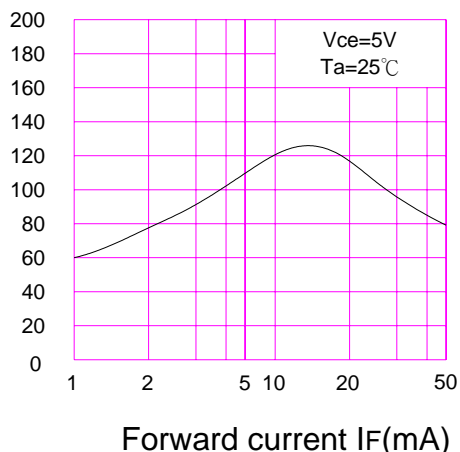

Classification table of current transfer ratio is shown below.

Model NO.	CTR(%)
KP12101E	50 TO 600

PRODUCT SPECIFICATION

DATE: 09/21/2006

cosmo ELECTRONICS CORPORATION	Photocoupler :	NO.60P00036	REV.
	KP1210	SHEET 4 OF 6	3

Fig.2 Collector Power Dissipation vs. Ambient Temperature

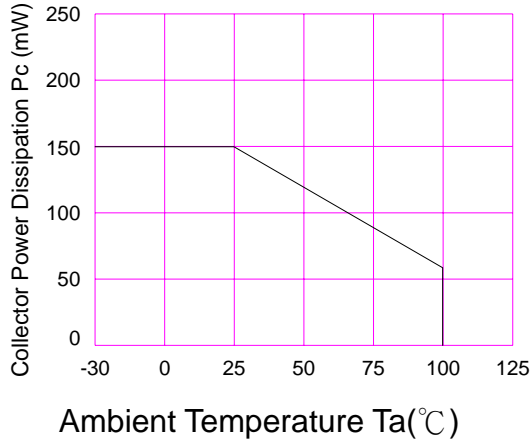

Fig.3 Collector Dark Current vs. Ambient Temperature

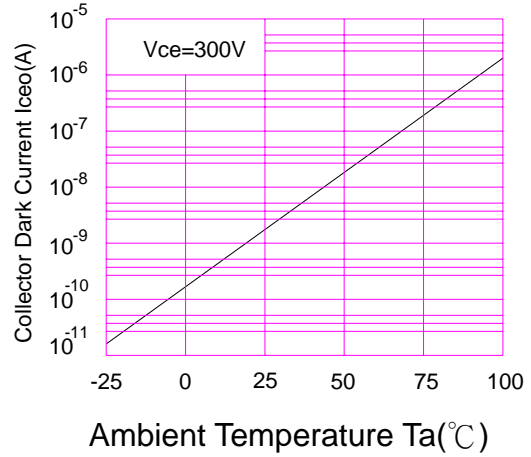

Fig.4 Forward Current vs. Ambient Temperature

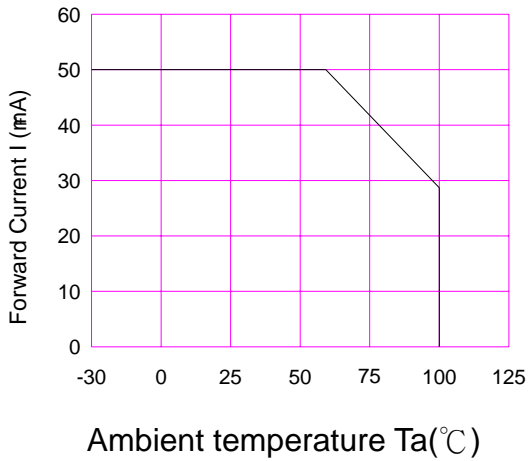

Fig.5 Forward Current vs. Forward Voltage

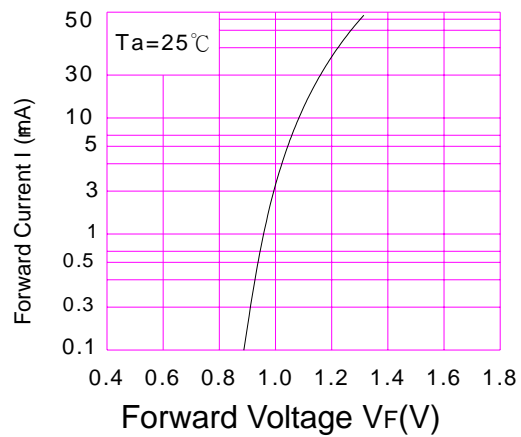

Fig.6 Collector Current vs. Collector-emitter Voltage

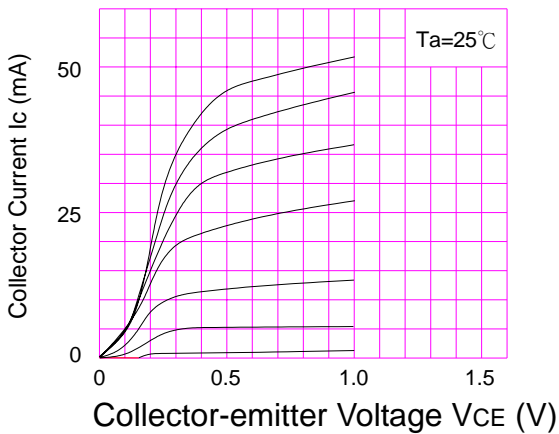
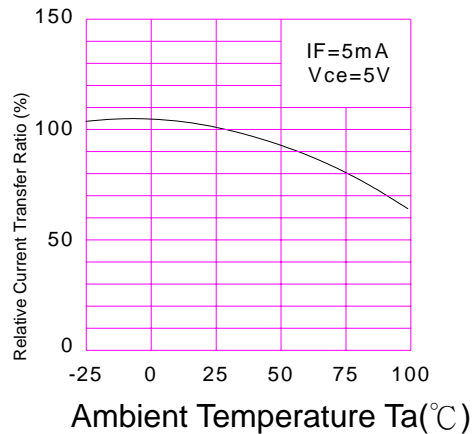

Fig.7 Relative Current Transfer Ratio vs. Ambient Temperature



PRODUCT SPECIFICATION

DATE: 09/21/2006

cosmo ELECTRONICS CORPORATION	Photocoupler :	NO.60P00036	REV.
	KP1210	SHEET 5 OF 6	3

Fig.8 Collector-emitter Saturation Voltage vs. Ambient Temperature

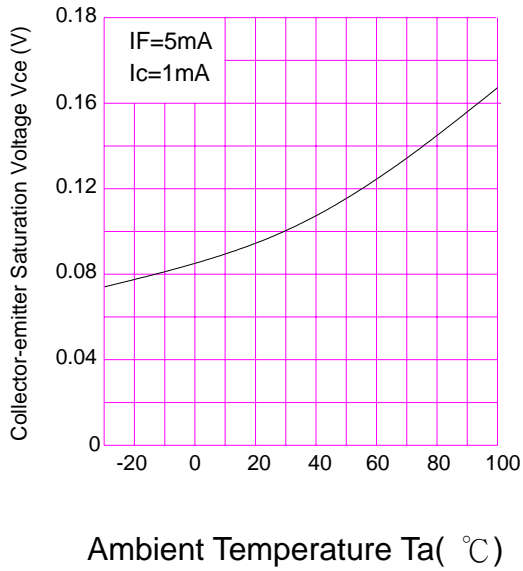

Fig.9 Collector-emitter Saturation Voltage vs. Forward Current

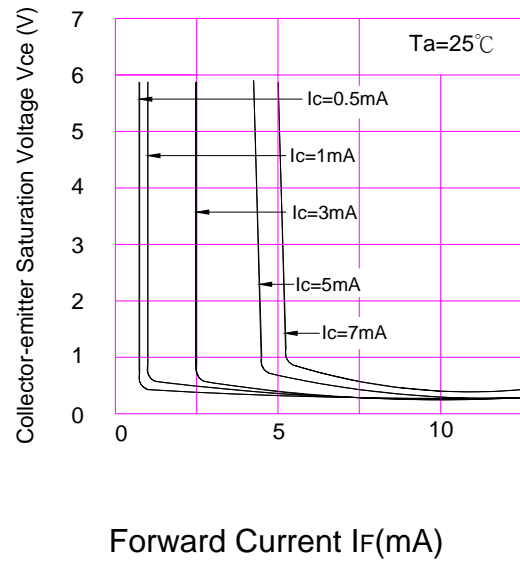

Fig.10 Response Time vs. Load Resistance

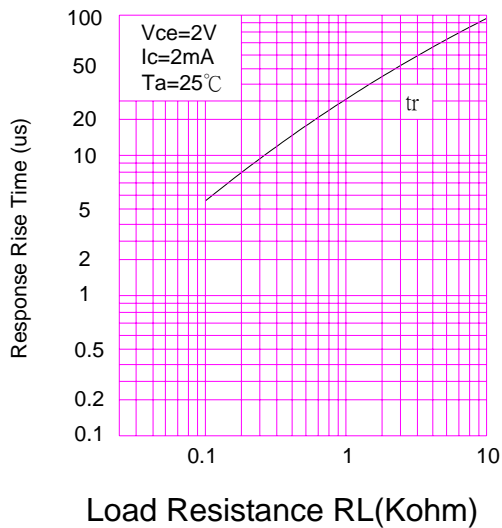
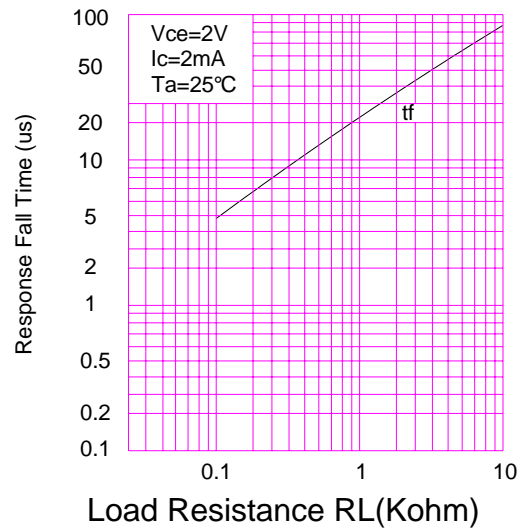

Fig.11 Response Time vs. Load Resistance



PRODUCT SPECIFICATION

DATE: 09/21/2006

cosmo ELECTRONICS CORPORATION	Photocoupler : KP1210	NO.60P00036	REV. 3
		SHEET 6 OF 6	

NOTICE

The information contained in this document is a general product description and is subject to change without notice. Please contact cosmo in order to obtain the latest device data sheets before using any cosmo device. Cosmo does not assume any responsibility for use of any circuitry described. No circuit patent licenses are implied. This publication is the property of cosmo. No part of this publication may be reproduced or copied in any form or by any means, or transferred to any third party without the prior written consent of cosmo Electronics Corporation.

The devices listed in this document are designed for general applications only in electronic equipment. No devices shall be deployed which require higher level of reliability such as:

- Medical and other life support equipments.
- Space application.
- Telecommunication equipment (trunk lines).
- Nuclear power control equipment.

Unless it received prior written approval from cosmo.

cosmo takes no responsibility for damages arise form the improper usage of our device. Please contact cosmo for further information regarding the above notices.