

### Features

1. Current transfer ratio  
(CTR:MIN.50% at  $I_F=5mA$   $V_{CE}=5V$ )
2. High isolation voltage between input and output  
(Viso:5000Vrms).
3. Compact dual-in-line package.
4. Available package : DIP/ SMD/ H.

### Applications

1. Registers, copiers, automatic vending machines.
2. System appliances, measuring instruments.
3. Computer terminals, programmable controllers.
4. Communications, telephone, etc.
5. Electric home appliances, such as oil fan heaters, Microwave oven, Washer, Refrigerator, Air conditioner, etc.
6. Medical instruments, physical and chemical equipment.
7. Signal transmission between circuits of different potentials and impedances.
8. Facsimile equipment, Audio, Video.
9. Switching power supply, Laser beam printer.

### Outside Dimension : Unit (mm)

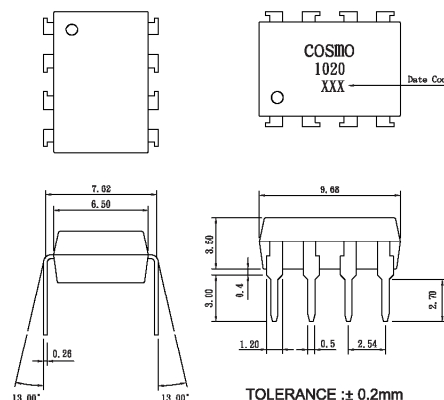

### Schematic : Top View

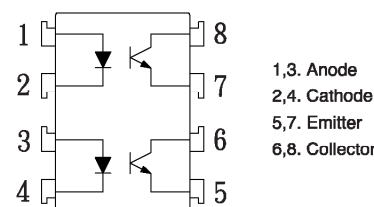

### Absolute Maximum Ratings

( $T_a=25^\circ C$ )

Parameter	Symbol	Rating	Unit
Input	Forward current	$I_F$	50
	Peak forward current	$I_{FM}$	1
	Reverse voltage	$V_R$	6
	Power dissipation	$P_D$	70
Output	Collector-emitter voltage	$V_{CEO}$	60
	Emitter-collector voltage	$V_{ECO}$	6
	Collector current	$I_C$	50
	Collector power dissipation	$P_C$	150
Total power dissipation	$P_{tot}$	200	
Isolation voltage 1 minute	$V_{iso}$	5000	
Operating temperature	$T_{opr}$	-30 to +100	
Storage temperature	$T_{stg}$	-55 to +125	
Soldering temperature 10 second	$T_{sol}$	260	

### Electro-optical Characteristics

( $T_a=25^\circ C$ )

Parameter	Symbol	Conditions	MIN.	TYP.	MAX.	Unit
Input	Forward voltage	$I_F=20mA$	—	1.2	1.4	V
	Peak forward voltage	$I_{FM}=0.5A$	—	—	3.0	V
	Reverse current	$V_R=4V$	—	—	10	$\mu A$
	Terminal capacitance	$V=0, f=1kHz$	—	30	—	pF
Output	Collector dark current	$V_{CE}=20V$	—	—	0.1	$\mu A$
Transfer characteristics	Current transfer ratio	$I_F=5mA, V_{CE}=5V$	50	—	600	%
	Collector-emitter saturation voltage	$I_F=20mA, I_C=1mA$	—	0.1	0.2	V
	Isolation resistance	DC500V	$5 \times 10^{10}$	$10^{11}$	—	ohm
	Floating capacitance	$V=0, f=1MHz$	—	0.6	1.0	pF
	Cut-off frequency	$V_{CC}=5V, I_C=2mA, R_L=100ohm$	—	80	—	kHz
	Response time (Rise)	$V_{CE}=2V, I_C=2mA, R_L=100ohm$	—	4	18	$\mu s$
	Response time (Fall)		—	3	18	$\mu s$

Classification table of current transfer ratio is shown below.

Model NO.	CTR (%)
KP1020 E	50 TO 600
KP1020 F	160 TO 600

**Fig.1** Current Transfer Ratio vs. Forward Current

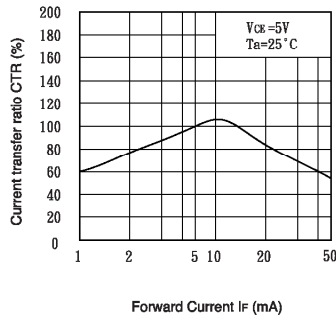

**Fig.2** Collector Power Dissipation vs. Ambient Temperature

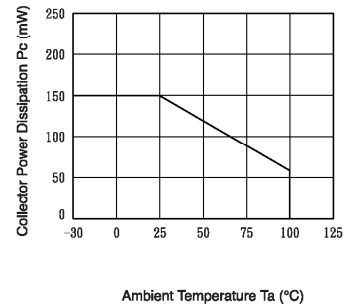

**Fig.3** Collector Dark Current vs. Ambient Temperature

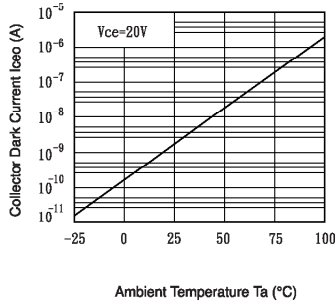

**Fig.4** Forward Current vs. Ambient Temperature

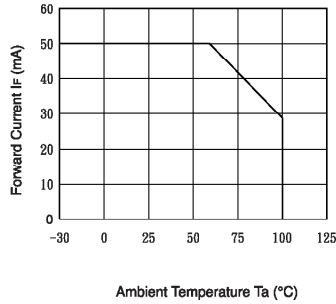

**Fig.5** Forward Current vs. Forward Voltage

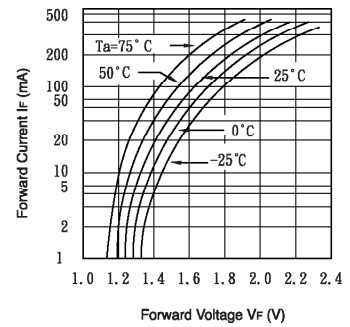

**Fig.6** Collector Current vs. Collector-emitter Voltage

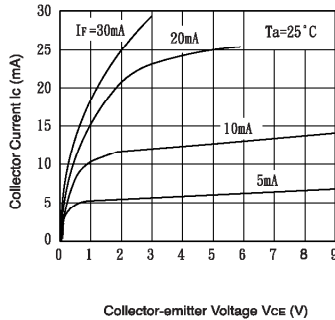

**Fig.7** Relative Current Transfer Ratio vs. Ambient Temperature

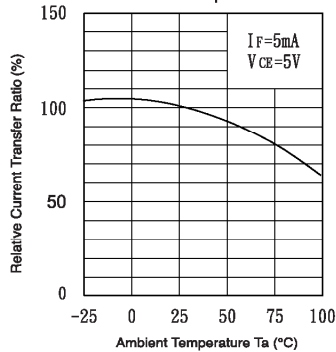

**Fig.8** Collector-emitter Saturation Voltage vs. Ambient Temperature

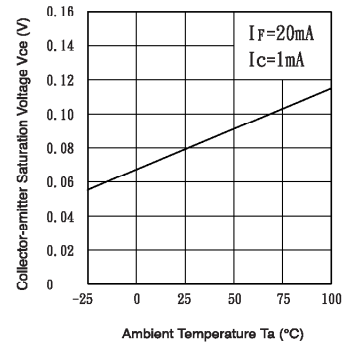

**Fig.9** Collector-emitter Saturation Voltage vs. Forward Current

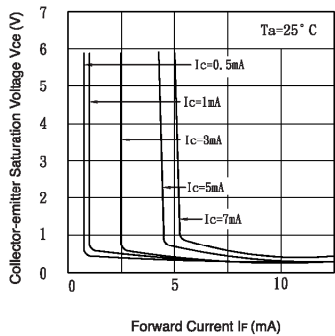

**Fig.10** Response Time vs. Load Resistance

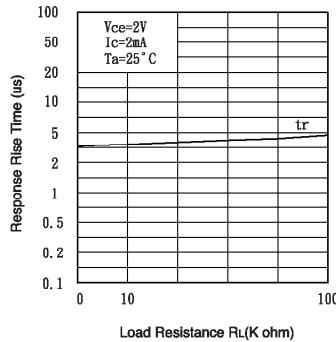

**Fig.11** Response Time vs. Load Resistance

