

SPECIFICATION FOR APPROVAL

REF. :

PROD. NAME	Shielded SMD Power Inductor	ABC'S DWG NO.		DH3025□□□□F□-□□□		
		REV.	20150824-C	PAGE	1	

I . Configuration and dimensions :

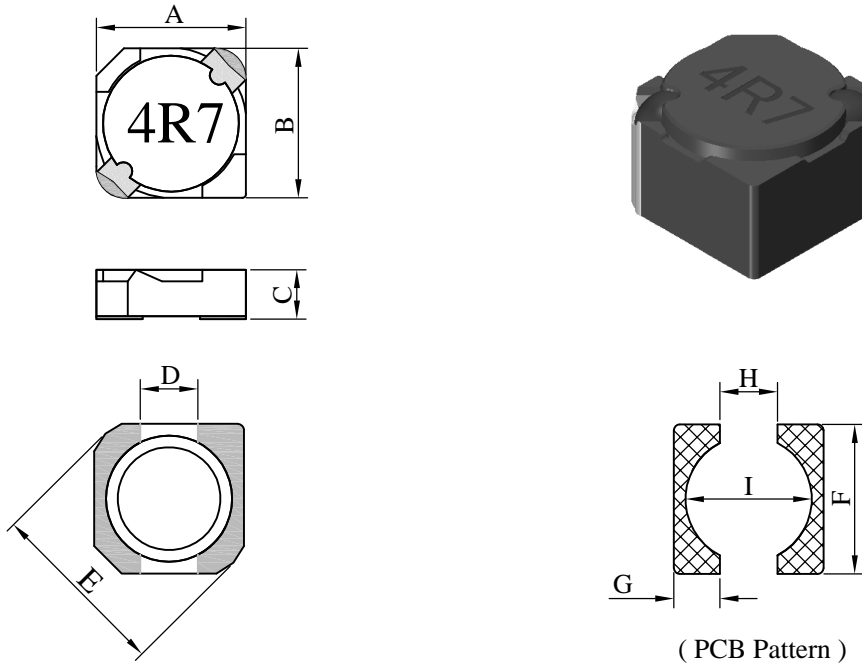

Unit : m/m

A	B	C	D	E	F	G	H	I
4.00 max.	4.00 max.	2.50 max.	1.40 typ.	4.80 typ.	4.20 ref.	1.40 ref.	1.30 ref.	3.10 ref.

II . Description :

- a . Ferrite drum core construction.
- b . Magnetically shielded.
- c . Enamelled copper wire : H class
- d . Product weight : 0.130g (ref.)
- e . Moisture sensitivity Level 1
- f . Products comply with RoHS' requirements
- g . Halogen free available

III . General specification :

- a . Storage temp. : -40°C ----+125°C
- b . Operating temp. : -40°C----+125°C
(Temp. rise included)
- c . Resistance to solder heat : 260°C.10 secs.

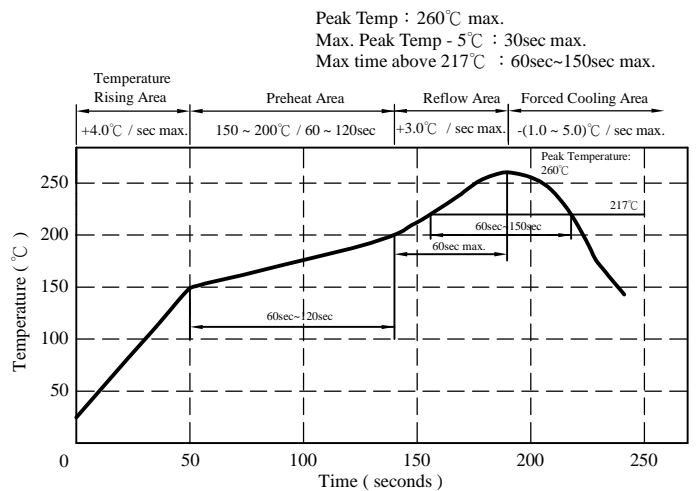

AR-001C

SPECIFICATION FOR APPROVAL

REF. :

PROD. NAME	Shielded SMD Power Inductor	ABC'S DWG NO.	DH3025□□□□F□-□□□		
		REV.	20150824-C	PAGE	2

IV . Electrical characteristics :

DWG No.	Inductance (μ H)	RDC (m Ω)		Rated Current (A) Max.
		Ref.	Max.	
DH30251R0YF□-□□□	1.0 \pm 30%	20	28	2.30
DH30252R2YF□-□□□	2.2 \pm 30%	30	42	1.53
DH30253R3YF□-□□□	3.3 \pm 30%	41	57	1.35
DH30254R7YF□-□□□	4.7 \pm 30%	48	67	0.97
DH30256R8YF□-□□□	6.8 \pm 30%	70	98	0.85
DH3025100YF□-□□□	10.0 \pm 30%	99	133	0.72
DH3025150YF□-□□□	15.0 \pm 30%	134	180	0.63
DH3025220YF□-□□□	22.0 \pm 30%	196	265	0.54
DH3025330YF□-□□□	33.0 \pm 30%	290	390	0.40

- 1). □ : Packaging information : □ Code
- 2). "-□□□" : Reference code
- 3). Electrical specifications at 25°C
- 4). Inductance Test Condition. : 100kHz / 0.1V
- 5). Rated Current base on Temp. rise 40°C max.
& $\Delta L/L0A = 35\%$ max.

AR-001C

SPECIFICATION FOR APPROVAL

REF. :

PROD. NAME	Shielded SMD Power Inductor	ABC'S DWG NO.	DH3025□□□□F□-□□□		
		REV.	20150824-C	PAGE	3

V . Curve :

DH30251R0YF□

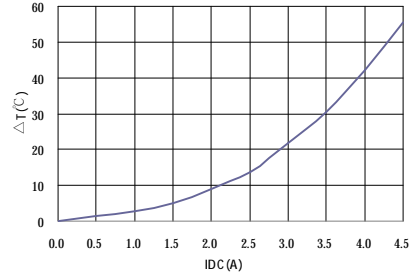
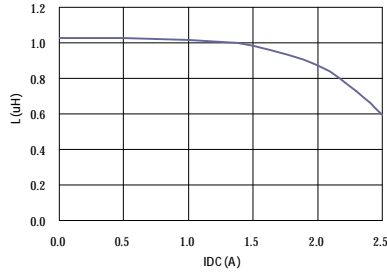

DH30254R7YF□

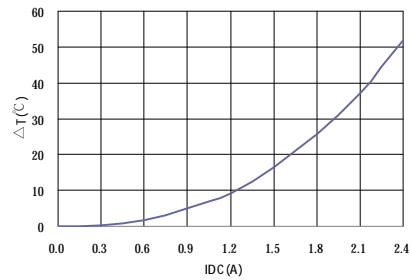
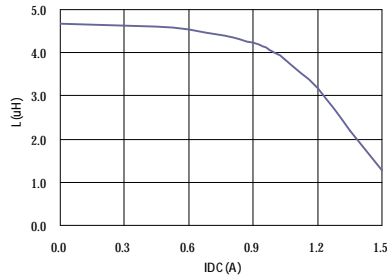

DH3025100YF□

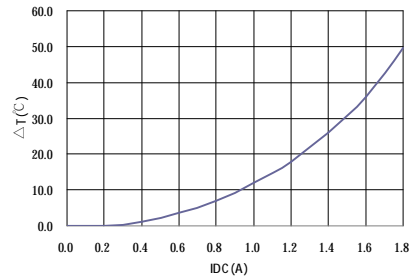
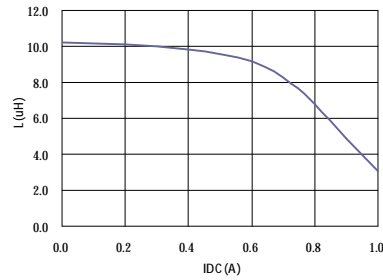

DH3025330YF□

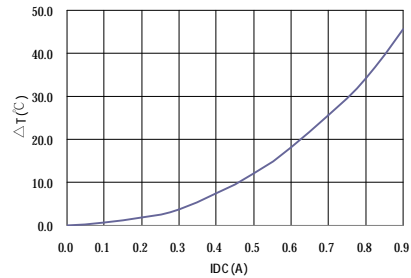
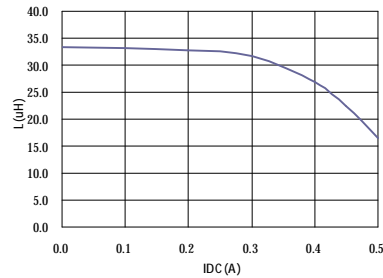

AR-001C

SPECIFICATION FOR APPROVAL

REF. :

PROD. NAME	Shielded SMD Power Inductor	ABC'S DWG NO.		DH3025□□□□F□-□□□	
		REV.	20150824-C	PAGE	4

V . Packaging information :

(1) Configuration

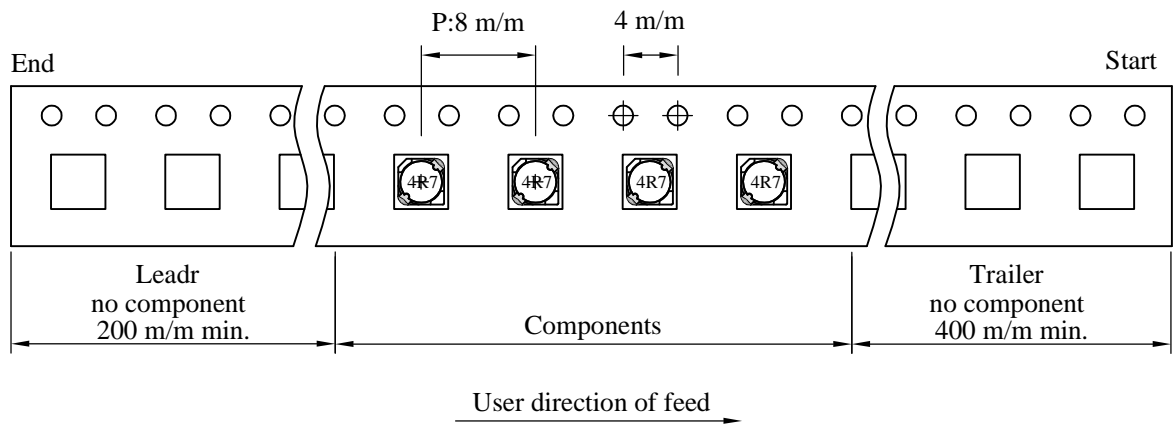
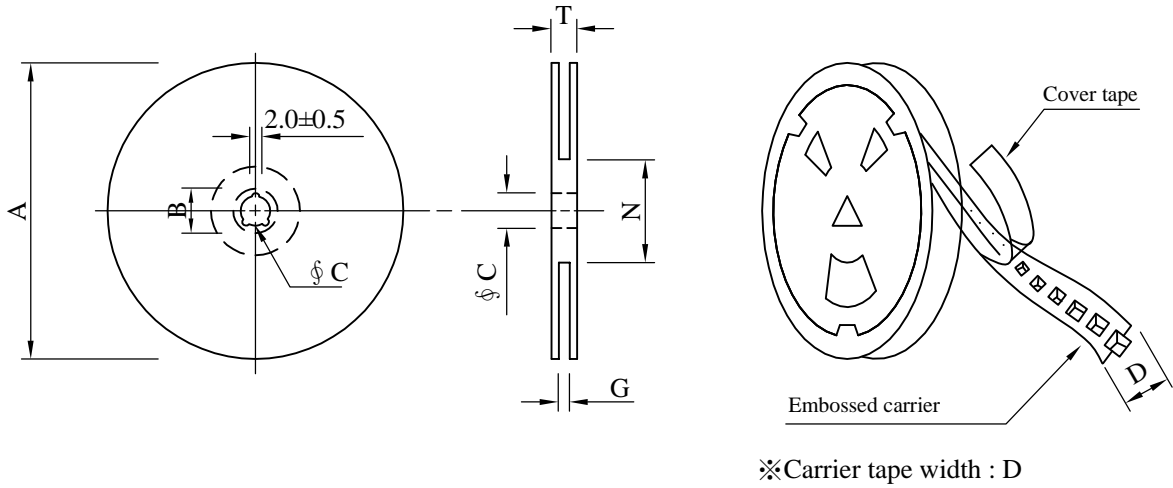

(2) Dimensions

Unit:m/m

Style	A	B	C	D	G	N	T
07 - 12	178	21±0.8	13	12	14 +0	50 -0	16.5

(3) Q'TY & G.W. Per package

Code	Inner : Reel			Outer : Carton		
	Q'TY (pcs)	G.W. (gw)	Style	Q'TY (pcs)	G.W. (Kg)	Size (cm)
B	800	210	07 - 12	32,000	9.8	42 x 41 x 24

AR-001C

SPECIFICATION FOR APPROVAL

REF. :

PROD. NAME	Shielded SMD Power Inductor	ABC'S DWG NO.	DH3025□□□□F□-□□□		
		REV.	20150824-C	PAGE	5

VII . Reliability test :

Item	Reference documents	Test Condition	Test Specification
1.High Temperature Exposure	MIL-STD-202 Method 108	1.Temperature: 125±2℃ 2.Time:96±2 hours.	1.No mechanical or electrical damage. 2.Inductance shall not change more than ±20%.
2.Temperature Cycling	JESD22-A 104	1.Temperature: -40℃ ~ +125℃ 2.Number of cycle:100 cycle 3.Dwell time:30 minutes	1.No mechanical or electrical damage. 2.Inductance shall not change more than ±20%.
3.Biased Humidity Test	MIL-STD-202 Method 103	1.Temperature : 85±2 ℃ 2.Humidity: 85% RH. 3.Time:96±2 Hours	1.No mechanical or electrical damage. 2.Inductance shall not change more than ±20%.
4.Operational Life	JESD22-A 108	1.Temperature: 125℃ (Temp. rise included) 2.Time:96±2 hours. 3.Rated current	1.No mechanical or electrical damage. 2.Inductance shall not change more than ±20%.
5.External Visual	JESD22-B 101 & MIL-STD-883 Method 2009	Inspect product constructions, marking and workmanship.	1.No pollution on the surface of products. 2.Clear marking. 3.No crack.
6.Physical Dimensions	JESD22-B 100	Verify physical dimensions to the applicable product detail specification.	Per product specification standard
7.Resistance to solvents	MIL-STD-202 Method 215	Immerse into solvent for 3±0.5 minutes & brush 10 times for 3 cycles.	1.No body change in appearance. 2.No marking blurred. 3.Inductance shall not change more than ±20%.
8. Vibration Test	MIL-STD-202 Method 204	1.Frequency and Amplitued : 10-2000-10 Hz, 1.5 mm. 2.Direction:X, Y, Z 3.Test duration:2 hours for each direction, 6 hours in total.	1.No mechanical or electrical damage. 2.Inductance shall not change more than ±20%.
9.Resistance To Soldering Heat Test	MIL-STD-202 Method 210 & J-STD020D.1	1.Highest temperature : 260±5℃. 2.Time (temp. ≥ 217℃) : 60~150 Second. 3.IR reflow times : 3 times.	1.No mechanical or electrical damage. 2.Inductance shall not change more than ±20%.
10.Saturation Current	JIS C 6436 & User SPEC.	1.Applied rated current for 5 second. 2.Saturation current	Inductance shall not drop more than 35% max.
11.Over load	JIS C 6436 & User SPEC.	1.Applied one and half rated current for a period of 5 minutes. 2.Rated current	No electrical or mechanical damage
12.Temperature Rise Current	JIS C 6436 & User SPEC.	1.Applied rated current for 10 minutes. 2.Temperature measure by digital surface thermometer. 3.Irms current	Surface temperature rise is less than 40℃ max.
13.Solderability Test	J-STD-002 & JESD22-B 102	1.Baking in pre-testing : 150±5℃ / 16Hours±30 min. 2.Peak temperature : 240±5℃ 3.Time (temp. ≥ 217℃) : 60~150 second. 4.IR reflow times : 1 times.	More than 95% soldering coverage min on terminations.
14.Electrical Characteriazation	MIL-STD-202 Method 304 & User SPEC.	1.Operating temperature : -40℃~125℃ 2.Room temperature : 25℃.	1.No mechanical or electrical damage. 2.Inductance shall not change more than ±20%.
15.Drop	CNS-C6354 & GB/T 2423.8	1.Products shall be mounted on SPEC. PCB and dropped down from a height of 1m 2.Drop total time : 6 time (Every side of sample drop 2 time)	1. Adhesion on PCB shall be enough. 2. Product appearance shall not break. 3. No electrical damage.
16.Terminal Strength Test	IEC 60068-2-21	1.Apply push force to samples mounted on PCB. 2.Force of 1.8 kg for 60±1 seconds.	After test, inductors shall be no mechanical damage.

AR-001C