



CT110

XtremeSense™ High Linearity, High-Resolution TMR Current Sensor with FLAG Output in Miniature Form Factor

Features

- AC or DC Current Range:
 - +5.0 A_{DC} / ±5.0 A_{PK}
 - +10.0 A_{DC} / ±10.0 A_{PK}
 - +15.0 A_{DC} / ±15.0 A_{PK}
- Resolution: 5 mA
- Total Output Error: <±0.5% (Typical)
- 2 kV Isolation per IEC 60950-1:2005
- Sampling Frequency: 200 kHz
- Supply Current: ~1.2 mA
- FLAG Pin to Detect 90% and 10% of Full Current Range
 - Active LOW Digital Output (Push-pull)
- Supply Voltage: 2.7 V to 5.5 V
- Operating Temperature Ranges:
 - Industrial: -40°C to +85°C
 - Extended Industrial: -40°C to +125°C
- Package: 6-lead DFN, 3.00 × 3.00 × 0.95 mm

Applications

- Shunt Resistor plus Isolation Amplifier Replacement
- Smart Plugs/IoT Devices
- LED Lighting Products
- Power Tools
- Appliances
- Drones
- Battery Charger Systems
- PCs and Servers

Product Description

The CT110 is a high linearity and high-resolution contact current sensor with isolation from Crocus Technology that is designed with its patented state-of-the-art XtremeSense™ TMR technology for high performance. It measures the current flowing through the DFN package via its integrated Current Carrying Conductor (CCC) and converts it to an analog ratio-metric output voltage that represents the current. The CT110 achieves superior performance with a typical total output error of less than ±0.5% and is capable of sensing current as low as 5 mA providing unmatched resolution. It supports a wide operating voltage range of 2.7 V to 5.5 V which allows it to be used in variety of applications.

It is an ideal solution to replace shunt resistor plus isolation amplifier. At the same time, the CT110 simplifies design, PCB layout and saves PCB area. It is capable of supporting up to 15.0 A of AC and DC current.

Also, the CT110 has a sampling frequency of 200 kHz but only has minimal current consumption of 1.0 mA to bias it since the measured current does not go through the device. Additionally, the CT110 integrates a FLAG output that is active LOW and will indicate when the field is above 90% and below 10% the full field range.

It is available in a low profile and small form factor 3.00 × 3.00 × 0.95 mm, 6-lead DFN package.

CT110 Block Diagram

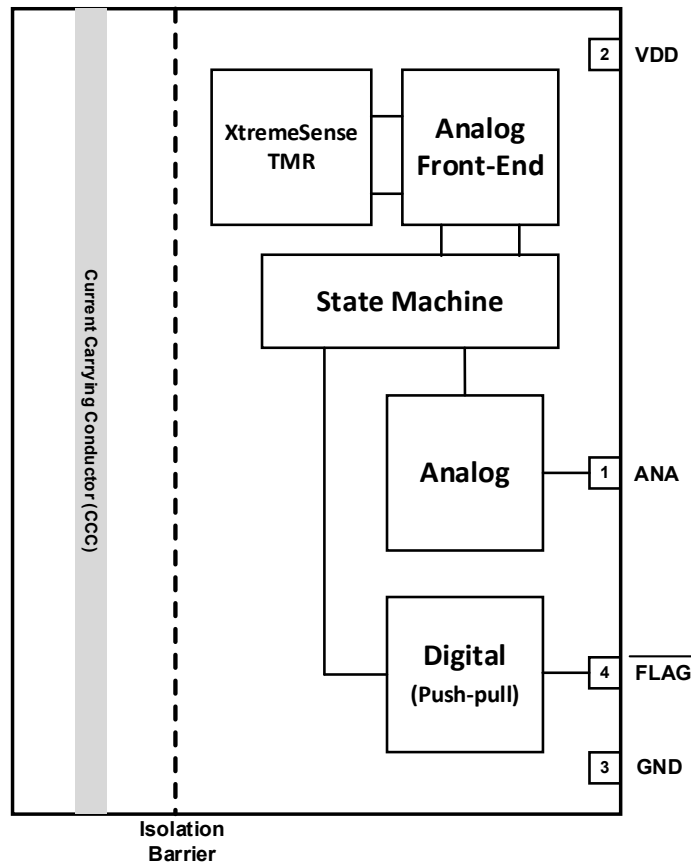

Figure 1. CT110 with Analog and FLAG Outputs in DFN-6 Package Block Diagram

CT110 Direction of Current Flow Diagrams

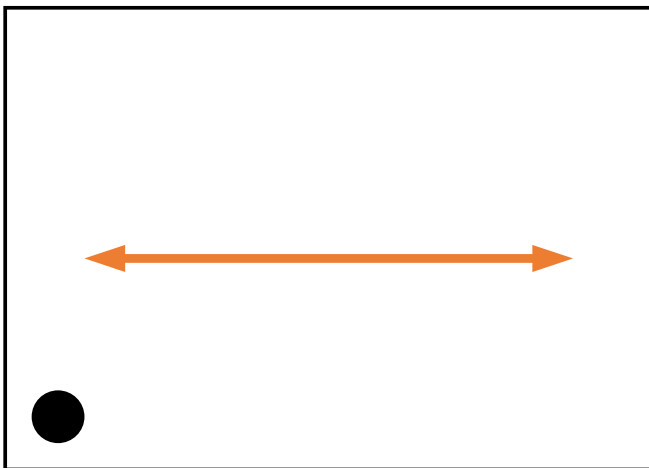

Figure 2. CT110: Direction of AC Current Flow for DFN-6.

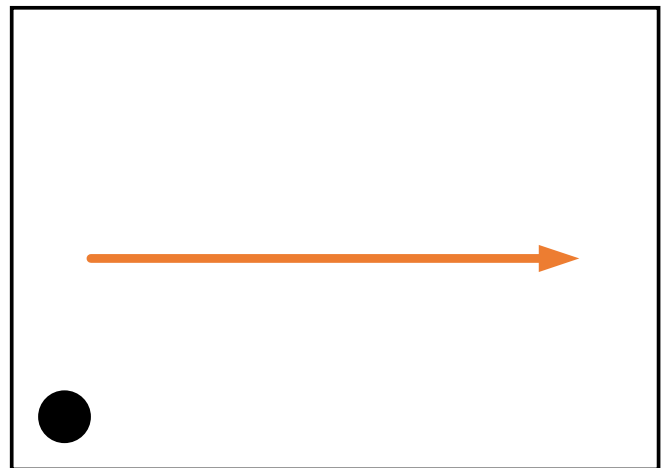

Figure 3. CT110: Direction of DC Current Flow for DFN-6.

DFN Pin Configuration

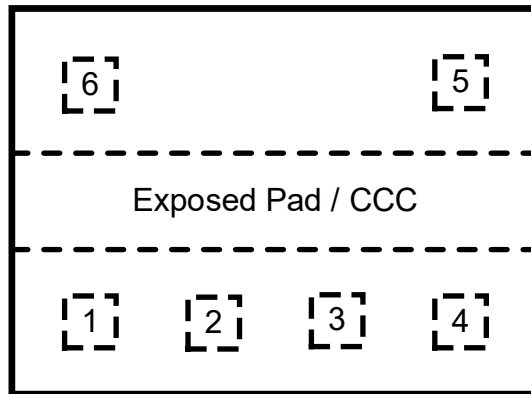

Figure 4. 6-Lead DFN Package, Top View (Thru Package)

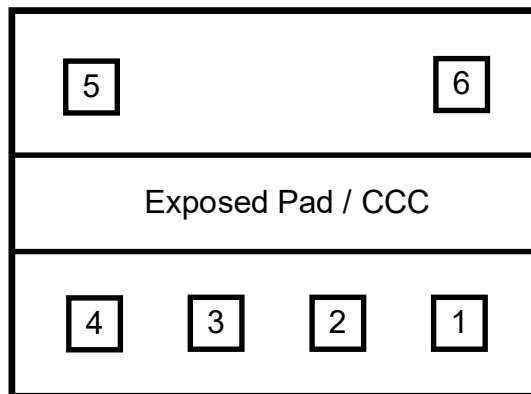

Figure 5. 6-Lead DFN Package, Bottom-up View

Pin Definitions

Pin # for 6-Lead DFN	Pin Name	Pin Description
1	ANA	Analog output voltage that represents the measured current.
2	VDD	Supply Voltage
3	GND	Ground
4	$\overline{\text{FLAG}}$	Outputs an active LOW flag signal to indicate when there the current is above 90% or below 10% of the full current range. It is a push-pull output.
5	N/C	No Connect
6	N/C	No Connect

Absolute Maximum Ratings

Stresses exceeding the absolute maximum ratings may damage the CT110 and may not function or be operable above the recommended operating conditions and stressing the parts to these levels is not recommended. In addition, extended exposure to stresses above the recommended operating conditions may affect device reliability. The absolute maximum ratings are stress ratings only.

Symbol	Parameter	Min.	Typ.	Max.	Unit
V _{DD}	Supply Voltage strength	-0.3		6.0	V
V _{FLAG#_PP}	Push-pull Output (Active LOW)	-0.3		V _{DD} + 0.3*	V
V _{I/O}	Input/Output Pins Maximum Voltage	-0.3		V _{DD} + 0.3*	V
I _{IN} / I _{OUT}	Input and Output Current			±10.0	mA
ESD	Electrostatic Discharge Protection Level	Human Body Model (HBM) per JESD22-A114			kV
T _J	Junction Temperature	-40		+150	°C
T _{STG}	Storage Temperature	-65		+150	°C
T _L	Lead Soldering Temperature, 10 Seconds			+260	°C

*The lower of V_{DD} + 0.3 V or 6.0 V.

Recommended Operating Conditions

The Recommended Operating Conditions table defines the conditions for actual operation of the CT110. Recommended operating conditions are specified to ensure optimal performance to the specifications. Crocus Technology does not recommend exceeding them or designing to absolute maximum ratings.

Symbol	Parameter	Min.	Typ.	Max.	Unit
V _{DD}	Supply Voltage Range	2.7	5.0	5.5	V
V _{OUT}	Output Voltage Range	0		V _{DD}	V
I _{OUT}	Output Current			±3.0	mA
T _A	Operating Ambient Temperature	Industrial	+25	+85	°C
		Extended Industrial	+25	+125	

Isolation Rating

Symbol	Parameter	Min.	Typ.	Max.	Unit
V _{ISO}	Dielectric Strength Test (Rated Isolation) Voltage		2.0		kV _{RMS}
		Tested for 60 s per IEC 60950-1:2005 +Am1:2009 + Am2:2013 and UL1577			

Thermal Properties

Junction-to-ambient thermal resistance is a function of application and board layout and is determined in accordance to JEDEC standard JESD51 for a four (4) layer 2s2p FR-4 printed circuit board (PCB) with 2 oz. of copper (Cu). Special attention must be paid not to exceed junction temperature T_{J(MAX)} at a given ambient temperature T_A.

Symbol	Parameter	Min.	Typ.	Max.	Unit
θ _{JA}	Junction-to-Ambient Thermal Resistance, DFN-6		162	187	°C/W

Electrical Specifications

General Parameters

Unless otherwise specified: $V_{DD} = 2.7\text{ V to }5.5\text{ V}$, $C_{BYP} = 1.0\ \mu\text{F}$ and $T_A = -40^\circ\text{C to }+125^\circ\text{C}$. Typical values are $V_{DD} = 5.0\text{ V}$ and $T_A = +25^\circ\text{C}$.

Symbol	Parameter	Conditions	Min.	Typ.	Max.	Unit
$I_{DD(AVG)}$	Average Supply Current	$t \geq 10\text{ s}$		1.2	2.5	mA
f_s	Sampling Frequency		150	200	250	kHz
t_{IDLE}	Idle Mode Time	$f_s = 200\text{ kHz}$	4.0	5.0	6.7	μs
R_{CCC_DFN}	Resistance of CCC in DFN Package ⁽¹⁾			0.9		m Ω
Analog Output (ANA)						
$I_{DRV(MAX)}$	Maximum Drive Capability	$\Delta V_{OUT} \leq 150\text{ mV}$, $V_{DD} \geq 3.3\text{ V}$	-10		+10	μA
V_{ANA}	Analog Output Voltage Range		$0.05 \times V_{DD}$		$0.95 \times V_{DD}$	V
V_{OQ}	Voltage Output Quiescent		48.5	50.0	51.5	% V_{DD}
t_{RISE}	Rise Time ⁽¹⁾	$I_{CCC} = I_{CCC(MAX)}$, $t_{VANA_90\%} - t_{VANA_10\%}$		15.5		μs
t_{DELAY}	Propagation Delay ⁽¹⁾	$I_{CCC} = I_{CCC(MAX)}$, $t_{ICCC} - t_{VANA}$ @ 20% of output value		4.6		μs
t_{RESP}	Response Time ⁽¹⁾	$I_{CCC} = I_{CCC(MAX)}$, $t_{ICCC} - t_{VANA}$ @ 90% of output value		20.0		μs
e_{ND}	Input Referred Noise Density ⁽¹⁾	$f_{BW} = 10\text{ Hz}$		250		$\mu\text{A}_{RMS}/\sqrt{\text{Hz}}$
C_L	Output Capacitive Load				10	pF
FLAG Push-pull Output (FLAG)						
$V_{FLAG\#_OL}$	$\overline{\text{FLAG}}$ Voltage LOW	AC & DC Current		$0.9 \times V_{DD}$		V
		AC Current		$0.1 \times V_{DD}$		
$V_{FLAG\#_OH}$	$\overline{\text{FLAG}}$ Voltage HIGH	AC & DC Current		$0.86 \times V_{DD}$		V
		AC Current		$0.14 \times V_{DD}$		
$I_{FLAG\#}$	Current for $\overline{\text{FLAG}}$			± 2		mA
Timings						
t_{ON}	Power-On Time	$V_{DD} \geq 2.7\text{ V}$		50	75	μs
t_{ACTIVE}	Active Mode Time			2.5		μs
Protection						
V_{UVLO}	Under-Voltage Lockout	Rising V_{DD}		2.3	2.5	V
		Falling V_{DD}	2.0	2.2		V
V_{UV_HYS}	UVLO Hysteresis			100		mV

(1) Guaranteed by design and characterization; not tested in production.

Typical Timing & Electrical Characteristics

V_{DD} = 5.0 V, T_A = +25°C and C_{BYP} = 1.0 μF (unless otherwise specified).

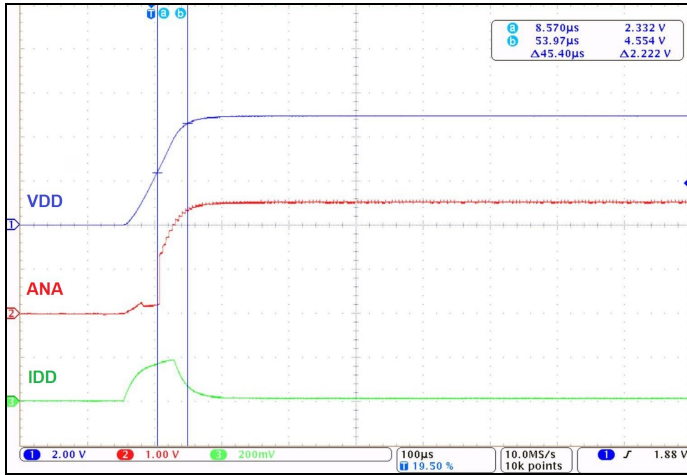

Figure 6. Power-On Time for CT110

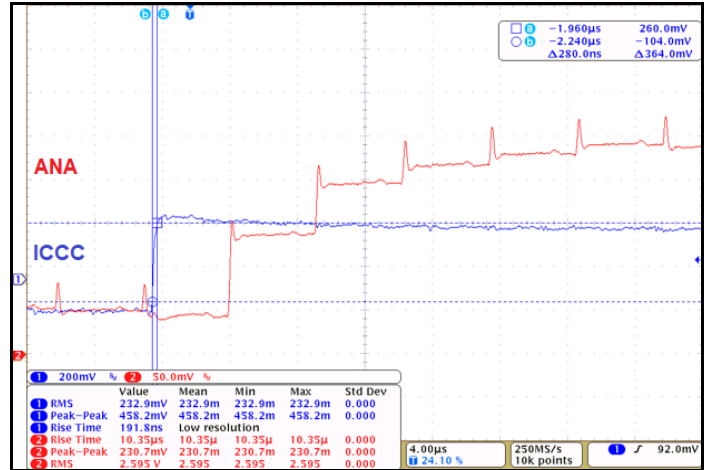

Figure 7. Rise Time for CT110

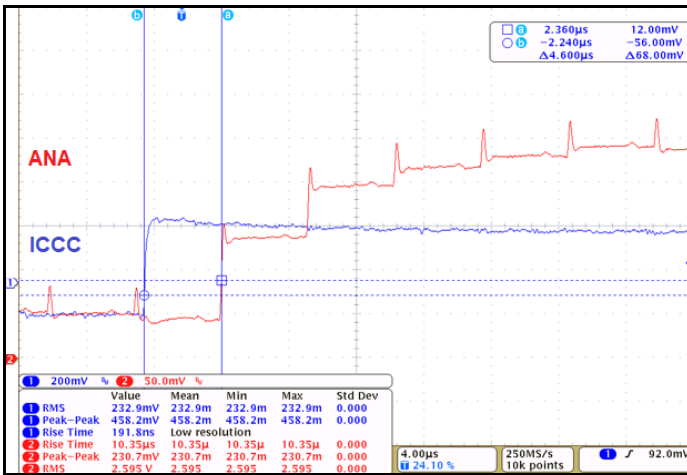

Figure 8. Propagation Delay Time for CT110

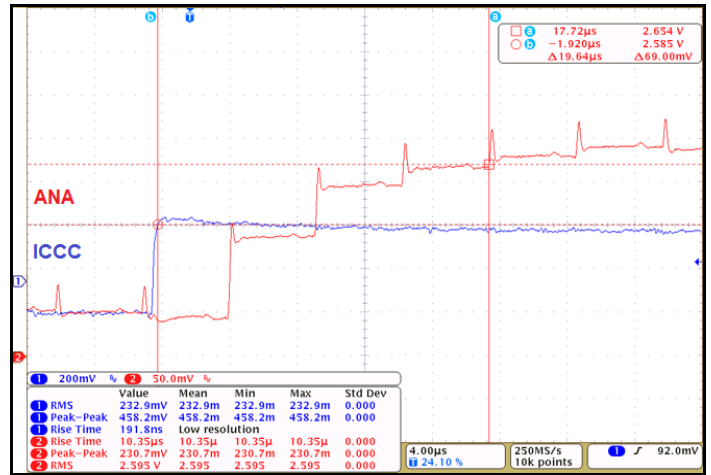

Figure 9. Response Time for CT110

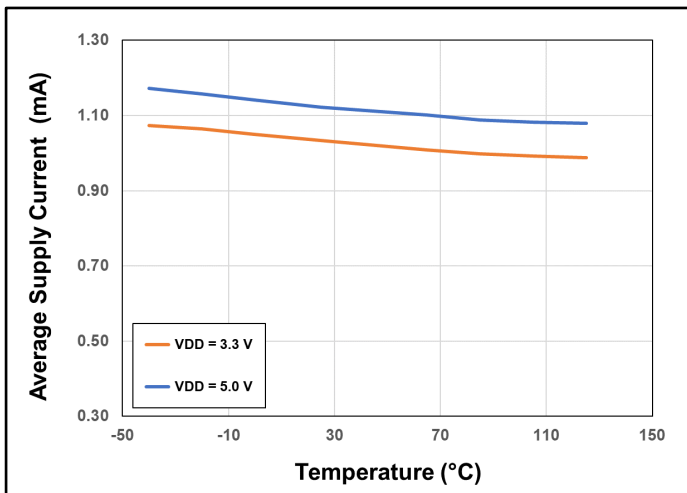

Figure 10. CT110 Average Supply Current vs. Temperature vs. Supply Voltage

Electrical Specifications

CT110FDx (+5.0 A_{DC} / ±5.0 A_{PK})

Unless otherwise specified: V_{DD} = 2.7 V to 5.5 V, C_{BYP} = 1.0 μF and T_A = -40°C to +125°C. Typical values are V_{DD} = 5.0 V and T_A = +25°C.

Symbol	Parameter	Conditions	Min.	Typ.	Max.	Unit
Analog Output						
G _{AC}	Gain for AC Current			88.2		mV/V/A
G _{DC}	Gain for DC Current			-88.2		mV/V/A
I _{CCC_AC}	AC Current Sensing Range ⁽¹⁾		-5		+5	A _{PK}
I _{CCC_DC}	DC Current Sensing Range ⁽¹⁾		-5		+5	A _{DC}
Resolution						
RES	Resolution	I _{CCC} = ±5 A		5		mA
Total Output Error Performance						
E _{TOT_FDC}	Total Output Error for CT110FDC	T _A = 0°C to +125°C		±0.5	±1.5	% FS
		T _A = -40°C to +125°C		±0.5	±3.0	
E _{TOT_FDV}	Total Output Error for CT110FDV	T _A = 0°C to +125°C		±0.5	±1.5	% FS
		T _A = -40°C to +125°C		±0.5	±5.0	
Total Output Error Components						
e _{LIN}	Non-Linearity Error	I _{CCC} = 5 A		±0.15		%
TCS _{FDC}	Temperature Coefficient of Sensitivity for CT110FDC ⁽¹⁾	T _A = 0°C to +125°C		-70		ppm/°C
		T _A = -40°C to +125°C		-150	-250	
TCS _{FDV}	Temperature Coefficient of Sensitivity for CT110FDV ⁽¹⁾	T _A = 0°C to +125°C		-100		ppm/°C
		T _A = -40°C to +125°C		-200	-400	
TCO	Temperature Coefficient of Offset Voltage ⁽¹⁾	T _A = -40°C to +125°C, V _{DD} = 5.0 V		100		ppm/°C
Noise						
e _N	Input Referred Noise ⁽¹⁾	f _{BW} = 1 Hz to 30 kHz, V _{DD} = 5.0 V		10		mA _{RMS}

(1) Guaranteed by design and characterization; not tested in production.

Typical Electrical Characteristics for CT110FDx

$V_{DD} = 5.0\text{ V}$, $T_A = +25^\circ\text{C}$ and $C_{BYP} = 1.0\ \mu\text{F}$ (unless otherwise specified).

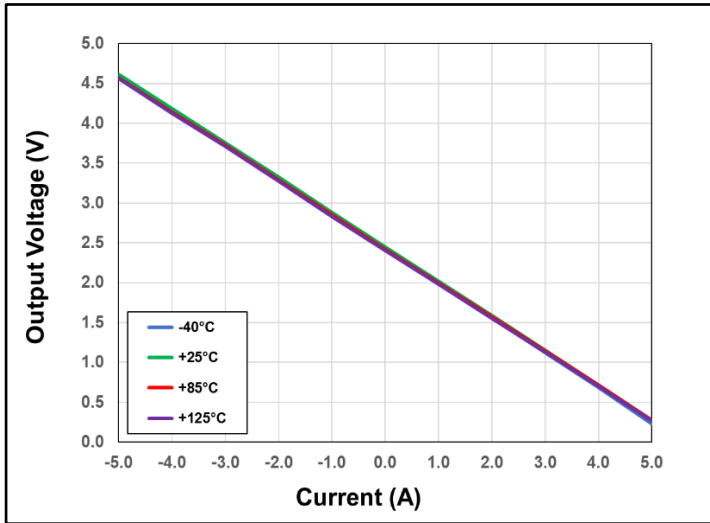

Figure 11. CT110FDx Output Voltage vs. Current vs. Temperature

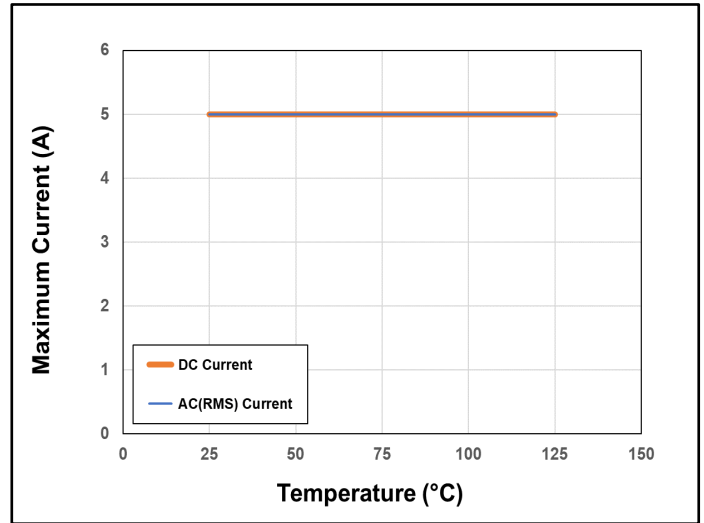

Figure 12. CT110FDx Maximum Current De-rating Curve

CT110PDx (+10.0 A_{DC} / ±10.0 A_{PK})

Unless otherwise specified: V_{DD} = 2.7 V to 5.5 V, C_{BYP} = 1.0 μF and T_A = -40°C to +125°C. Typical values are V_{DD} = 5.0 V and T_A = +25°C.

Symbol	Parameter	Conditions	Min.	Typ.	Max.	Unit
Analog Output						
G _{AC}	Gain for AC Current			44.1		mV/V/A
G _{DC}	Gain for DC Current			-44.1		mV/V/A
I _{CCC_AC}	AC Current Sensing Range ⁽¹⁾		-10		+10	A _{PK}
I _{CCC_DC}	DC Current Sensing Range ⁽¹⁾		-10		+10	A _{DC}
Resolution						
RES	Resolution	I _{CCC} = ±10 A		5.0		mA
Total Output Error Performance						
E _{TOT_PDC}	Total Output Error for CT110PDC	T _A = 0°C to +125°C		±0.5	±1.5	% FS
		T _A = -40°C to +125°C		±0.5	±3.0	
E _{TOT_PDV}	Total Output Error for CT110PDV	T _A = 0°C to +125°C		±0.5	±1.5	% FS
		T _A = -40°C to +125°C		±0.5	±5.0	
Total Output Error Components						
e _{LIN}	Non-Linearity Error	I _{CCC} = 10 A		±0.15		%
TCS _{PDC}	Temperature Coefficient of Sensitivity for CT110PDC ⁽¹⁾	T _A = 0°C to +125°C		-70		ppm/°C
		T _A = -40°C to +125°C		-150	-250	
TCS _{PDV}	Temperature Coefficient of Sensitivity for CT110PDV ⁽¹⁾	T _A = 0°C to +125°C		-100		ppm/°C
		T _A = -40°C to +125°C		-200	-400	
TCO	Temperature Coefficient of Offset Voltage ⁽¹⁾	T _A = -40°C to +125°C, V _{DD} = 5.0 V		100		ppm/°C
Noise						
e _N	Input Referred Noise ⁽¹⁾	f _{BW} = 1 Hz to 30 kHz, V _{DD} = 5.0 V		8		mA _{RMS}

(1) Guaranteed by design and characterization; not tested in production.

Typical Electrical Characteristics for CT110PDx

$V_{DD} = 5.0\text{ V}$, $T_A = +25^\circ\text{C}$ and $C_{BYP} = 1.0\ \mu\text{F}$ (unless otherwise specified).

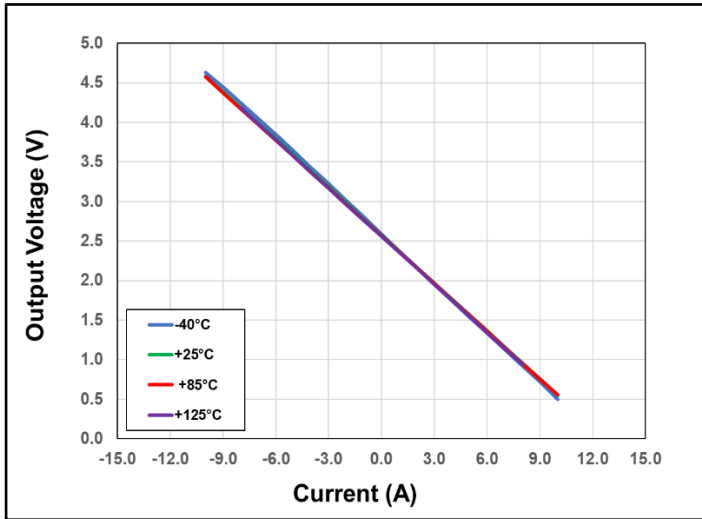

Figure 13. CT110PDx Output Voltage vs. Current vs. Temperature

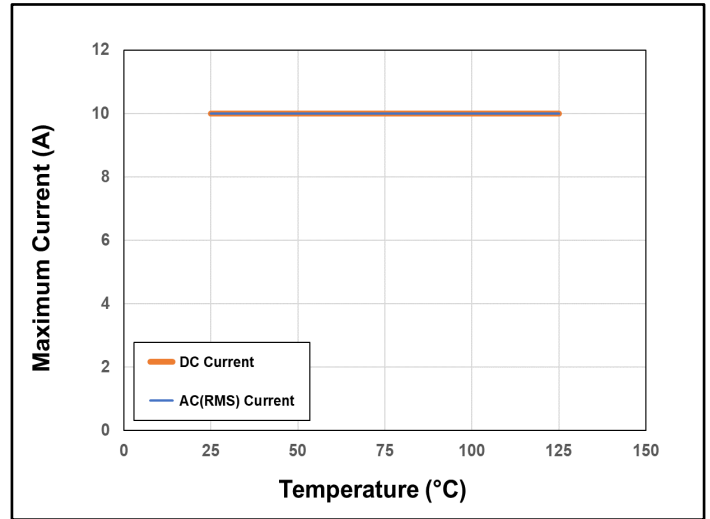

Figure 14. CT110PDx Maximum Current Derating Curve

CT110RDx (± 15.0 A_{PK})

Unless otherwise specified: $V_{DD} = 2.7$ V to 5.5 V, $C_{BYP} = 1.0$ μ F and $T_A = -40^\circ\text{C}$ to $+125^\circ\text{C}$. Typical values are $V_{DD} = 5.0$ V and $T_A = +25^\circ\text{C}$.

Symbol	Parameter	Conditions	Min.	Typ.	Max.	Unit
Analog Output						
G_{AC}	Gain for AC Current			30.0		mV/V/A
G_{DC}	Gain for DC Current			-30.0		mV/V/A
I_{CCC_AC}	AC Current Sensing Range ⁽¹⁾		-15		+15	A _{PK}
I_{CCC_DC}	DC Current Sensing Range ⁽¹⁾	$T_A = -40^\circ\text{C}$ to $+75^\circ\text{C}$	-15		+15	A _{DC}
		$T_A = +125^\circ\text{C}$	-12		+12	
Resolution						
RES	Resolution	$I_{CCC} = \pm 15$ A _{PK}		5		mA
Total Output Error Performance						
E_{TOT_RMC}	Total Output Error for CT110RDC	$T_A = 0^\circ\text{C}$ to $+125^\circ\text{C}$		± 0.5	± 1.5	% FS
		$T_A = -40^\circ\text{C}$ to $+125^\circ\text{C}$		± 0.5	± 3.0	
E_{TOT_RMV}	Total Output Error for CT110RDV	$T_A = 0^\circ\text{C}$ to $+125^\circ\text{C}$		± 0.5	± 1.5	% FS
		$T_A = -40^\circ\text{C}$ to $+125^\circ\text{C}$		± 0.5	± 5.0	
Total Output Error Components						
TCS_{RMC}	Temperature Coefficient of Sensitivity for CT110RDC ⁽¹⁾	$T_A = 0^\circ\text{C}$ to $+125^\circ\text{C}$		-70		ppm/ $^\circ\text{C}$
		$T_A = -40^\circ\text{C}$ to $+125^\circ\text{C}$		-150	-250	
TCS_{RMV}	Temperature Coefficient of Sensitivity for CT110RDV ⁽¹⁾	$T_A = 0^\circ\text{C}$ to $+125^\circ\text{C}$		-100		ppm/ $^\circ\text{C}$
		$T_A = -40^\circ\text{C}$ to $+125^\circ\text{C}$		-200	-400	
TCO	Temperature Coefficient of Offset Voltage ⁽¹⁾	$T_A = -40^\circ\text{C}$ to $+125^\circ\text{C}$, $V_{DD} = 5.0$ V		100		ppm/ $^\circ\text{C}$
Noise						
e_N	Input Referred Noise ⁽¹⁾	$f_{BW} = 1$ Hz to 30 kHz, $V_{DD} = 5.0$ V		8		mA _{RMS}

(1) Guaranteed by design and characterization; not tested in production.

Typical Electrical Characteristics for CT110RDx

$V_{DD} = 5.0\text{ V}$, $T_A = +25^\circ\text{C}$ and $C_{BYP} = 1.0\ \mu\text{F}$ (unless otherwise specified).

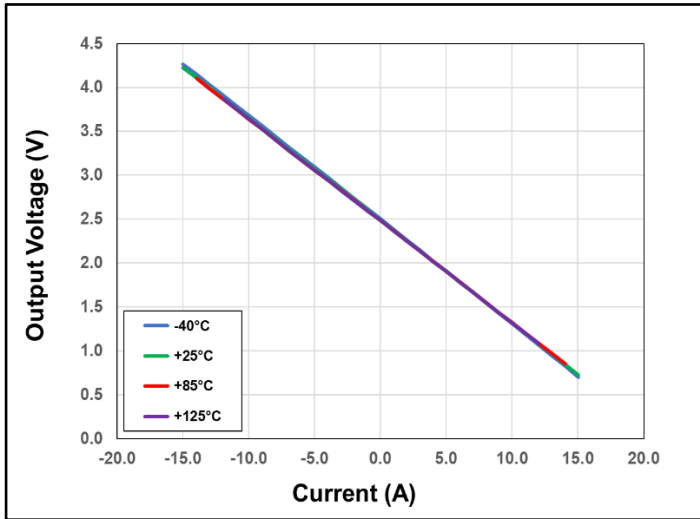

Figure 15. CT110RDx Output Voltage vs. Current vs. Temperature

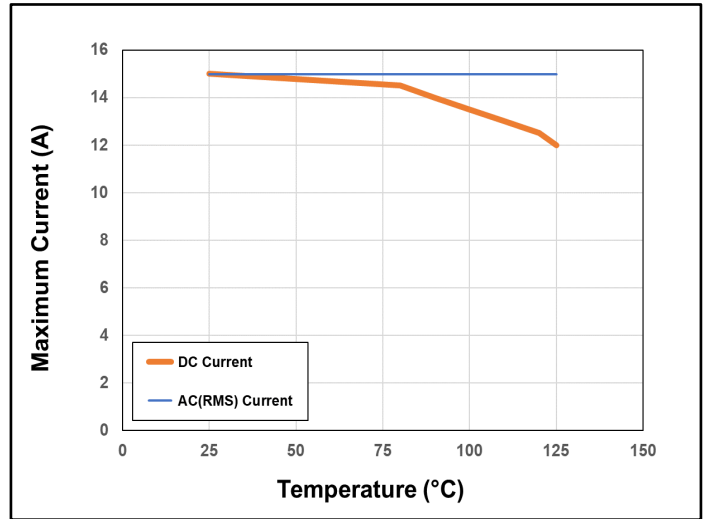

Figure 16. CT110RDx Maximum Current Derating Curve

Circuit Description

Overview

The CT110 is a high resolution and low noise contact current sensor with isolation and a $\overline{\text{FLAG}}$ output that operates from 2.7 V to 5.5 V assembled in a custom DFN package. The chip measures the magnetic field of the current through the package and converts it to an analog signal that is equivalent to the current flowing through the printed circuit board (PCB) trace. The $\overline{\text{FLAG}}$ output indicates whether there is an over-current condition seen by CT110 during operation and will alert the host system.

Analog Output Measurement

The CT110 provides a continuous (sample & hold) linear analog output voltage which represents the measured magnetic field of the current. The output voltage range of ANA is 5.0% of V_{DD} to 95.0% of V_{DD} which represents the current from the typical low-end values (-5.0 A to -15.0 A_{PK}) to the maximum current values (+5.0 A to +15.0 A_{PK}) respectively. The output sample frequency is 200 kHz. A resistor-capacitor (R-C) filter may be implemented on the ANA pin to further lower the noise. Figure 17 illustrates the output voltage range of the ANA pin as a function of the measured current for ± 5.0 A.

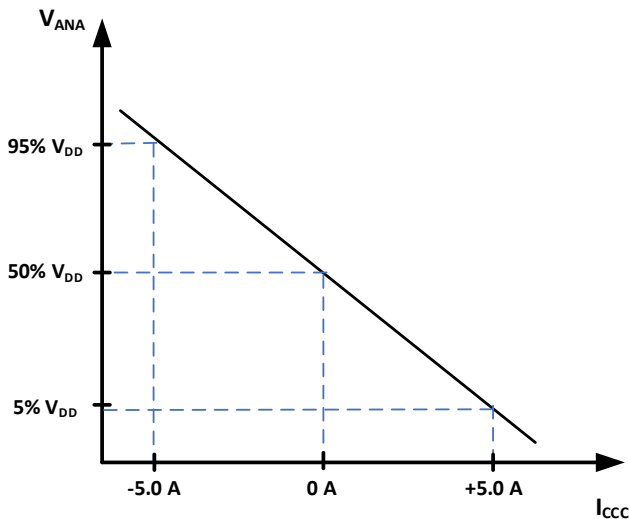

Figure 17. Linear Output Voltage Range vs. Measured Current for $G = -88.2$ mV/V/A and current range of ± 5.0 A.

90% & 10% Current Detection Flag

The Current Detection circuitry detects when the current measured through the current carrying conductor is above 90% or below 10% of the full current range. As a result, it translates to greater than 90% of the V_{DD} and 10% of the

V_{DD} on the ANA pin. This will generate a flag signal via the $\overline{\text{FLAG}}$ pin to the host system's microcontroller as an active LOW signal. Once the V_{ANA} falls below 86% or rises above 14% of the V_{DD} then the $\overline{\text{FLAG}}$ signal will go HIGH.

Rise Time (t_{RISE})

The CT110's rise time, t_{RISE} , is the time interval of when it reaches 10% and 90% of the full-scale output voltage. The t_{RISE} of the CT110 is 15.5 μs .

Propagation Delay (t_{DELAY})

The propagation delay, t_{DELAY} , is the time measured between the I_{CC} reaches 20% of its final value and the CT110 attains 20% of its full-scale output voltage. Its propagation delay is 4.6 μs .

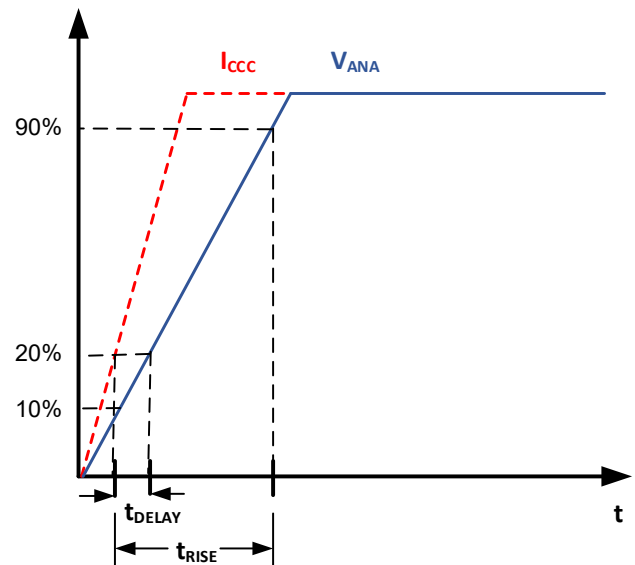

Figure 18. CT110 Propagation Delay and Rise Time Curve

Response Time (t_{RESP})

The response time, t_{RESP} , is the difference in time from when the I_{CC} reaches 90% of its final value and V_{ANA} attains 90% of its final value. The CT110's response time is typically 20.0 μs .

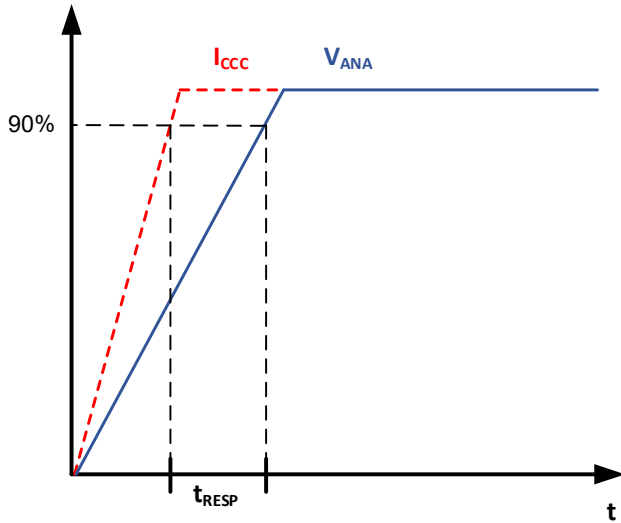

Figure 19. CT110 Response Time Curve

Power-On Time (t_{ON})

The Power-On Time (t_{ON}) of 50 μs is the amount of time required by the CT110 to start up, power-on and acquire the first sample. The chip is fully powered up and operational from the moment the supply voltage passes the rising UVLO point (2.3 V). This time includes the ramp up time and the settling time (within 10% of steady-state voltage when current is flowing through the package) after the power supply have reach the minimum V_{DD} .

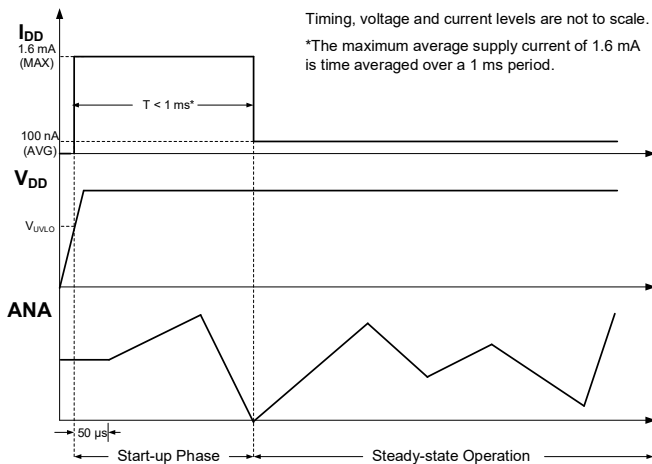

Figure 20. CT110 Power-On Timing Diagram

Under-Voltage Lockout (UVLO)

The Under-Voltage Lock-out protection circuitry of the CT110 is activated when the supply voltage (V_{DD}) falls below 2.1 V. The CT110 remains in a low quiescent state and the ANA output is not valid until V_{DD} rises above the UVLO threshold (2.3 V).

High Resolution and Low Noise

For DC current, the resolution is 5 mA while the input referred noise is 8 mA_{RMS} (up to 10 mA_{RMS}) however there is no contradiction in the CT110's capability to sense this level of current because the 5 mA was measured with a digital multi-meter (DMM) with limited bandwidth whereas the noise is over a wider bandwidth (up to 30 kHz).

CT110 Calibration Guide

Introduction

All current sensors, no matter how expensive they are, or what materials they use, or even if they were factory calibrated, are susceptible to deviations from their Ideal Transfer Line.

To extract the absolute best performance from any current sensing system, calibration is required.

Ideal Transfer Line

Ideally, the sensor output follows a straight line, has a fixed slope, and crosses a fixed offset point. This allows the user to apply a straightforward linear equation to extract the “physical” value being measured. In the case of a current sensor:

$$Current = \frac{Voltage - b}{a}$$

where a: slope and b: offset of the ideal curve. In a perfect sensor, both a and b coefficients can be simply looked up on the datasheet.

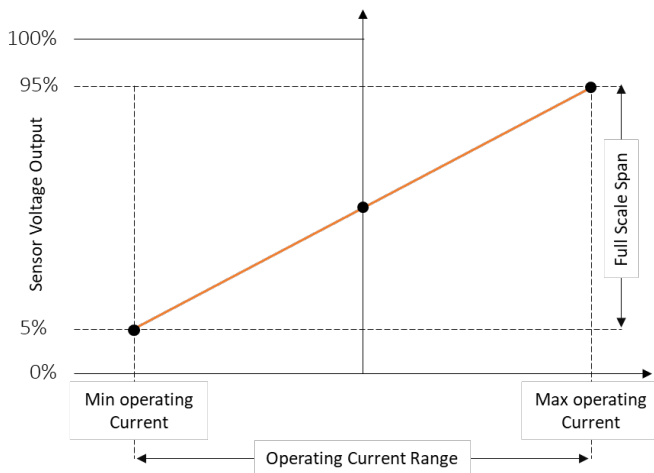

Figure 21. Ideal Transfer Line

Any deviation from this Ideal Line are considered sensor errors. More specifically Accuracy Errors as they related in the case of Crocus Technology’s sensors to Gain and Offset errors.

Offset Error

Based on the Ideal Transfer Line, when no current is applied, the voltage output of the sensor should be equal to 50% of V_{DD}. On the datasheet, the user can find the spread (i.e. min-max) values of offsets of Crocus Technology’s products.

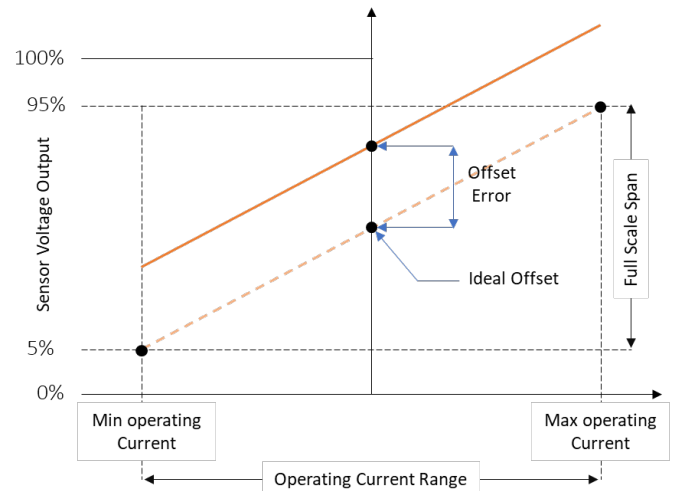

Figure 22. Exaggerated Offset Error

Gain Error

The Ideal Transfer Line shows a line that reaches 95% of V_{DD} at the maximum operating current and 5% of V_{DD} at the minimum. The datasheet also shows the spread of the gain found on the sensors.

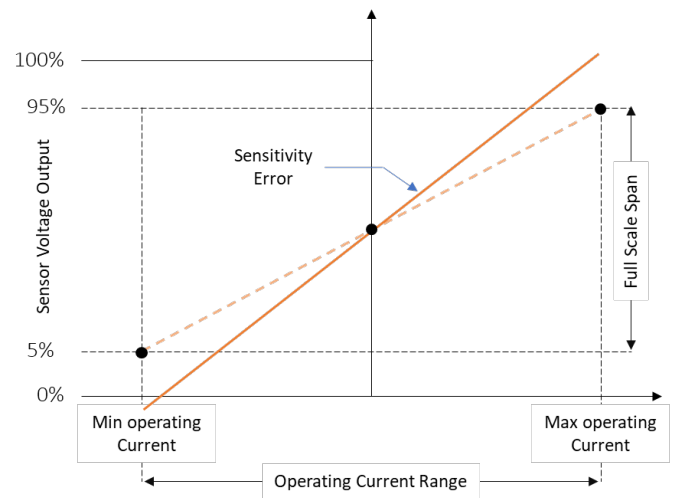

Figure 23. Exaggerated Gain Error

Calibration

Different methods can be applied for offset and/or gain correction. The complexity of these methods lead to different calibration results. The higher the complexity the better the error correction is.

Simple Offset Correction

Offset calibration is achieved simply by storing the voltage output of the sensor at zero flowing current.

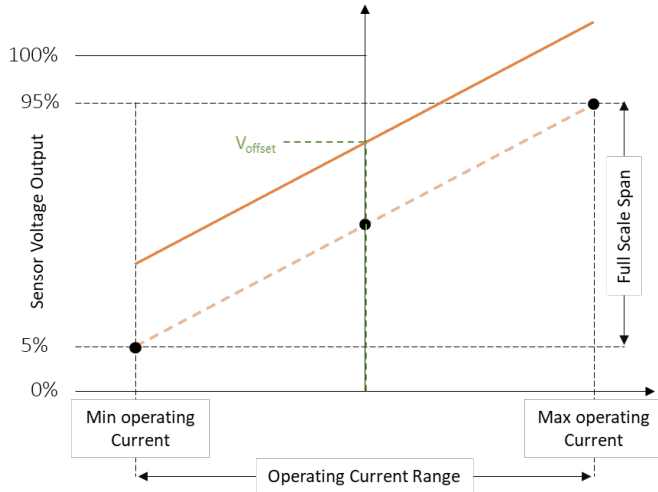

Figure 24. Simple Offset Calibration

This stored value V_{OFFSET} becomes the coefficient “b” in the linear transfer function:

$$Current = \frac{Voltage - b}{a}$$

Simple Gain Correction

Basic Gain calibration can be achieved by applying a known current value (A_1) and measure the sensor output voltage value (V_1)

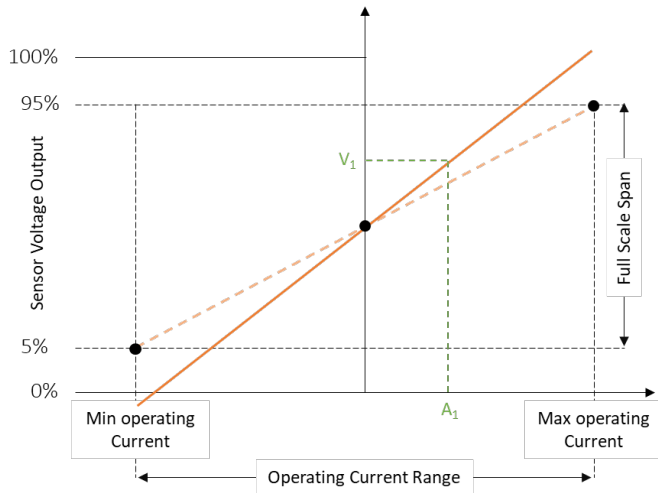

Figure 25. Simple Gain Calibration

The following equation is used to calculate the slope coefficient “a”:

$$a = \frac{V_1 - V_{OFFSET}}{A_1}$$

Recommended Offset and Gain Correction

For bi-directional current applications, the steps below are recommended for users trying to perform the best error correction of gain and offset.

1. Apply a known current value (A_1) and measure voltage output (V_1)
2. Apply a “second current value” (A_2) and measure the voltage output (V_2)
3. Calculate the slope using the following equation

It is recommended that the applied currents A_1 and A_2 are the absolute maximum and minimum operating current the sensor will see during its normal operations.

Also, $A_1 = -A_2$ for bi-directional current sensing.

$$a = \frac{V_1 - V_2}{A_1 - A_2} \qquad b = \frac{V_1 + V_2}{2}$$

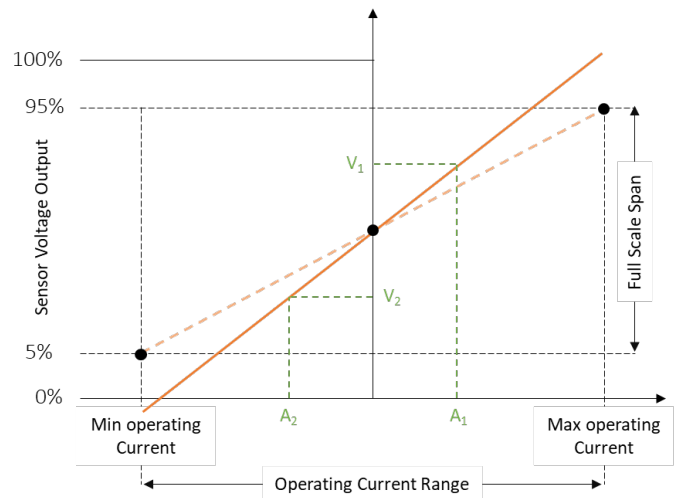

Figure 26. Gain Calibration

Both calculated coefficients “a” and “b” are then used to calculate the current:

$$Current = \frac{Voltage - b}{a}$$

Applications Information

The CT110 is able to replace a shunt resistor plus isolation amplifier circuit to measure the current in various applications. It has an embedded exposed pad that can support up to +10 A_{DC} or ±15.0 A_{PK} of current flow through the package. Figure 27 illustrates the CT110 where the PCB trace is connected to the current carrying conductor (CCC) to allow the current flow through it. The current that flows through the exposed pad generates a magnetic field and is sensed by the XtremeSense TMR sensor in the CT110 and converts it into a ratio-metric linear analog output voltage that is representative of the measured current. The C110 has at least 2 kV of isolation to protect low voltage circuits from high voltage circuits. The CT110 only needs a 1.0 µF bypass capacitor. A resistor-capacitor filter on the ANA pin is recommended to minimize the output noise as shown in Figure 27. Please refer to Table 2 for recommended cut-off frequencies.

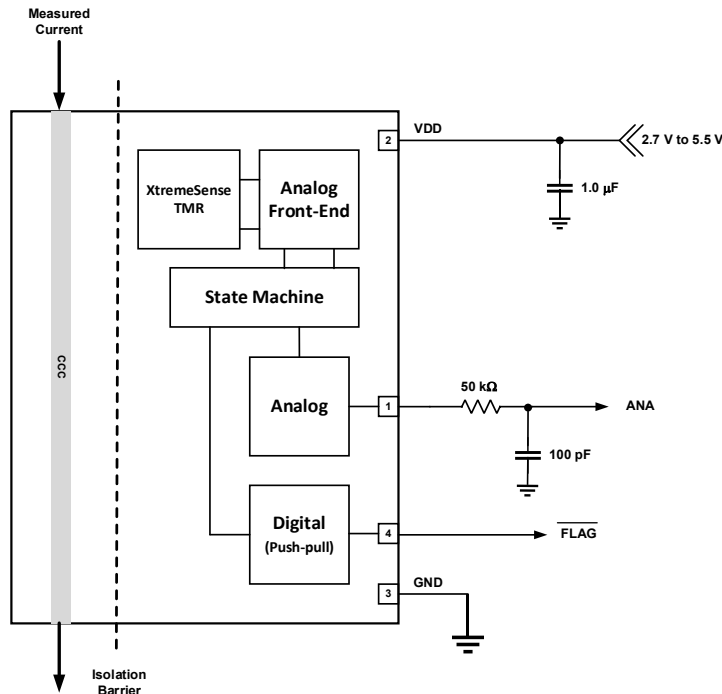

Figure 27. CT110 with Analog and FLAG Outputs Application Block Diagram

Table 1. Recommended External Components for CT110

Component	Description	Vendor & Part Number	Parameter	Min.	Typ.	Max.	Unit
C _{BYP}	1.0 µF, X5R or Better	Murata GRM155C81A105KA12	C		1.0		µF
R _{FILTER}	50 kΩ, ±5%	Various	R		47		kΩ
C _{FILTER}	10 pF, X5R or Better	Various	C		10		pF

Table 2. Recommended Cut-off Frequencies for CT110 and its Resistor-Capacitor Values

Cut-off Frequency (kHz)	Resistor Value (kΩ)	Capacitor Value (pF)
1	105	1,500
10	105	150
30	50	100

DFN-6 Package Drawings and Dimensions

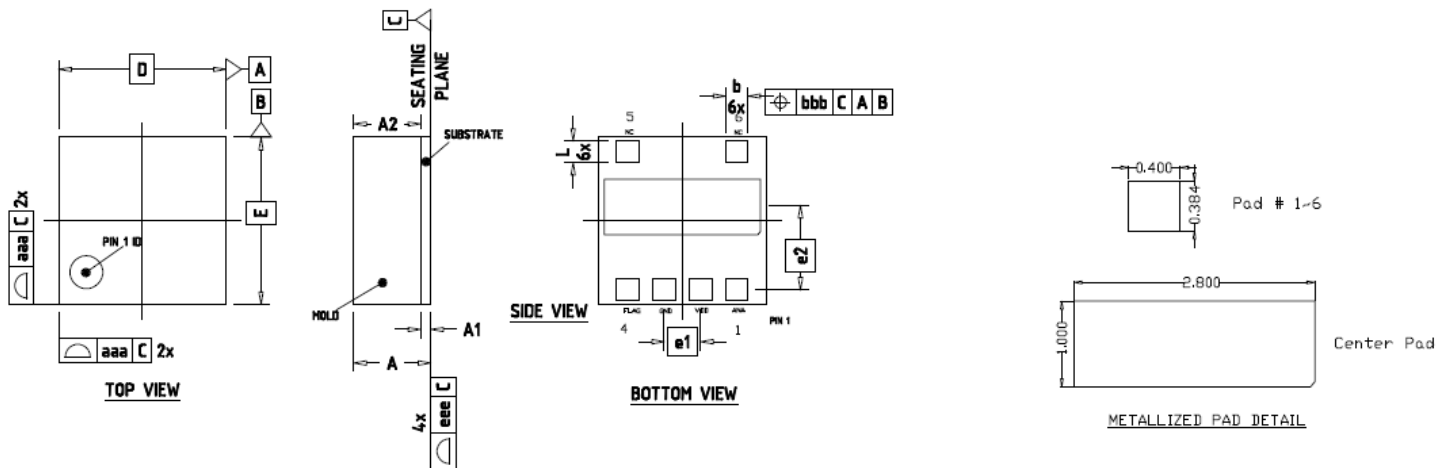

NOTES:

1. 'e' represents the basic terminal pitch. It specifies the geometric position of the terminal axis.
2. Dimension 'b' applies to the metalized terminal pads.
3. Dimension 'A' includes package warpage.
4. Exposed metalized pads are Cu (Copper) pads with OSP surface.
5. All dimensions are in millimeters (mm).

Figure 28. DFN-6 Package Drawing and Dimensions

Table 3. CT110 DFN-6 Package Dimensions

Symbol	Dimensions in Millimeters (mm)		
	Min.	Typ.	Max.
A	0.880	0.950	1.020
A1	0.200	0.250	0.270
A2	0.650	0.700	0.750
b	0.375	0.400	0.425
D	3.00 BSC		
E	3.00 BSC		
L	0.359	0.384	0.409
e1	0.65 BSC		
e2	1.50 BSC		
aaa	0.050		
bbb	0.050		
eee	0.050		

Crocus Technology provides package drawings as a service to customers considering or planning to use Crocus products in their designs. Drawings may change without notice. Please note the revision and date of the data sheet and contact a Crocus Technology representative to verify or obtain the most recent version. The package specifications do not expand the terms of Crocus Technology's worldwide terms and conditions, specifically the warranty therein, which covers Crocus Technology's products.

Package Information

Table 4. CT110 Package Information

Part Number	Package Type	# of Leads	Package Quantity	Lead Finish	Eco Plan ⁽¹⁾	Operating Temperature ⁽²⁾	Device Marking ⁽³⁾
CT110FDC-ID6	DFN	6	3,000	Sn	Green & RoHS	-40°C to +85°C	10FDC YYWWS
CT110FDC-HD6	DFN	6	3,000	Sn	Green & RoHS	-40°C to +125°C	10FDC YYWWS
CT110FDV-ID6	DFN	6	3,000	Sn	Green & RoHS	-40°C to +85°C	10FDV YYWWS
CT110FDV-HD6	DFN	6	3,000	Sn	Green & RoHS	-40°C to +125°C	10FDV YYWWS
CT110PDC-ID6	DFN	6	3,000	Sn	Green & RoHS	-40°C to +85°C	10PDC YYWWS
CT110PDC-HD6	DFN	6	3,000	Sn	Green & RoHS	-40°C to +125°C	10PDC YYWWS
CT110PDV-ID6	DFN	6	3,000	Sn	Green & RoHS	-40°C to +85°C	10PDV YYWWS
CT110PDV-HD6	DFN	6	3,000	Sn	Green & RoHS	-40°C to +125°C	10PDV YYWWS
CT110RDC-ID6	DFN	6	3,000	Sn	Green & RoHS	-40°C to +85°C	10RDC YYWWS
CT110RDC-HD6	DFN	6	3,000	Sn	Green & RoHS	-40°C to +125°C	10RDC YYWWS
CT110RDV-ID6	DFN	6	3,000	Sn	Green & RoHS	-40°C to +85°C	10RDV YYWWS
CT110RDV-HD6	DFN	6	3,000	Sn	Green & RoHS	-40°C to +125°C	10RDV YYWWS

- (1) RoHS is defined as semiconductor products that are compliant to the current EU RoHS requirements. It also will meet the requirement that RoHS substances do not exceed 0.1% by weight in homogeneous materials. Green is defined as the content of Chlorine (Cl), Bromine (Br) and Antimony Trioxide based flame retardants satisfy JS709B low halogen requirements of $\leq 1,000$ ppm.
- (2) Package will withstand ambient temperature range of -40°C to +150°C and storage temperature range of -65°C to +160°C.
- (3) Device Marking for DFN is defined as 10xDy where x = current rating of CT110 and y = total output error; and YYWWZ = date code information where YY = year, WW = work week and Z = sequential number.

Ordering Information

Part Number	Operating Temperature Range	Current Range	Package	Packing Method
CT110FDC-ID6	-40°C to +85°C	+5.0 A _{DC} / ±5.0 A _{PK}	6-lead DFN 3.00 x 3.00 x 0.95 mm	Tape & Reel
CT110FDC-HD6	-40°C to +125°C			
CT110FDV-ID6	-40°C to +85°C			
CT110FDV-HD6	-40°C to +125°C			
CT110PDC-ID6	-40°C to +85°C	+10.0 A _{DC} / ±10.0 A _{PK}	6-lead DFN 3.00 x 3.00 x 0.95 mm	Tape & Reel
CT110PDC-HD6	-40°C to +125°C			
CT110PDV-ID6	-40°C to +85°C			
CT110PDV-HD6	-40°C to +125°C			
CT110RDC-ID6	-40°C to +85°C	+15.0 A _{DC} / ±15.0 A _{PK}	6-lead DFN 3.00 x 3.00 x 0.95 mm	Tape & Reel
CT110RDC-HD6	-40°C to +125°C			
CT110RDV-ID6	-40°C to +85°C			
CT110RDV-HD6	-40°C to +125°C			

Disclaimer: The contents of this document are provided for informational purposes only. CROCUS TECHNOLOGY, INC. AND CROCUS TECHNOLOGY SA (COLLECTIVELY “CROCUS”) MAKE NO REPRESENTATIONS OR WARRANTY OF ANY KIND, EXPRESS OR IMPLIED, WITH RESPECT TO THE ACCURACY OR COMPLETENESS OF THE CONTENTS HEREIN, INCLUDING, BUT NOT LIMITED TO, THE IMPLIED WARRANTIES OF MERCHANTABILITY AND FITNESS FOR A PARTICULAR PURPOSE. Crocus reserves the right to make changes to the specifications and product descriptions, and/or to discontinue or make changes to its products at any time without notice. Crocus’s products have not been designed, tested, or manufactured for use and should not be used in applications where the failure, malfunction or inaccuracy of the Products carries a risk of death or serious bodily injury or damage to tangible property, including, but not limited to, life support systems, nuclear facilities, military, aircraft navigation or communication, emergency systems, harsh environments, or other applications with a similar degree of potential hazard.

Product Status Definition

Data Sheet Identification	Product Status	Definition
Objective	Proposed New Product Idea or In Development	Data sheet contains design target specifications and are subject to change without notice at any time.
Preliminary	First Production	Data sheet contains preliminary specifications obtained by measurements of early samples. Follow-on data will be published at a later date as more test data is acquired. Crocus reserves the right to make changes to the data sheet at any time.
None	Full Production	Data sheet contains final specifications for all parameters. Crocus reserves the right to make changes to the data sheet at any time.
Obsolete	Not in Production	Data sheet for a product that is no longer in production at Crocus. It is for reference only.