

Reference

1. Scope of Application

These specifications apply to chip type SMD photo-interrupter, type CPI-210-T.

2. Part code

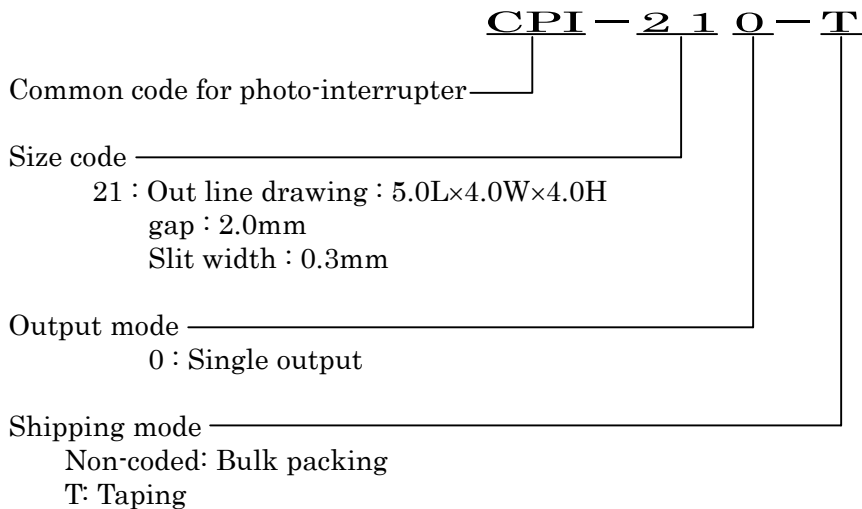

3.Special Note:

- 1) Reflow soldering must be done within 48 hours stored under 30°C, 80% after opening envelop.
- 2) Antiradiation requirement is not specified.
- 3) CPI series are not manufactured with and do not contain any Ozone Depleting Chemicals.
- 4) Country of Origin : Japan/ Fujiyoshida Factory.
- 5) If any questions arise for interpretation of these specifications, it shall be resolved by mutual consultation.

			Approved	Checked	Drawn	Symbol	PHOTO-INTERRUPTER
						Name	CPI-210
						Drawing No	
Mark	Date	Description	Appro.	CITIZEN ELECTRONICS CO.,LTD.			

4. Rating and Characteristics

Reference

4-1 Absolute maximum rating

(Ta=25°C)

Item		Symbol	Rating value	Unit
Input side	Power dissipation	PD	37.5	mW
	Forward current	IF	25	mA
	Pulse forward current *	IFP	100	mA
	Reverse voltage	VR	5	V
	Collector dissipation	PC	75	mW
Output side	Collector current	IC	20	mA
	Voltage between collector and emitter	VCEO	20	V
	Voltage between emitter and collector	VECO	5	V
Operating temperature range		TOP	-30 · +85	°C
Storage temperature range		TST	-40 · +90	°C

* Duty:1/100, Pulse Width:0.1msec

4-2 Electrooptical characteristics

(Ta=25°C)

Item		Symbol	Condition	Min	TYP	Max	Unit
Input side	Forward Voltage	VF	IF=5mA	-	1.1	1.3	V
	Reverse current	IR	VR=5V	-	-	10	μA
	Capacitance between terminals	Ct	V=0V,f=1KHz	-	30	-	pF
	Peak wave length	λP	IF=20mA	-	940	-	nm
Output side	Collector dark current	ICE	VCE=10V	-	-	0.1	μA
	Peak sensitive wave length	λP	-	-	900	-	nm
Transfer Characteristics	Current transfer ratio	IC	VCE=5V,IF=5mA	50	150	500	μA
	Collector to emitter saturation voltage	VCE(S)	IF=20mA,IC=50μA	-	0.1	0.4	V
	Rise time	tr	VCE=5V,IC=0.1mA	-	10	-	μsec
	Fall time	tf	RL=1KΩ	-	10	-	μsec

			Approved	Checked	Drawn	Symbol	PHOTO-INTERRUPTER
						Name	CPI-210
						Drawing No	
Mark	Date	Description	Appro.	CITIZEN ELECTRONICS CO.,LTD.			

Reference

5. Characteristics

Pd,Pc Ta Characteristics

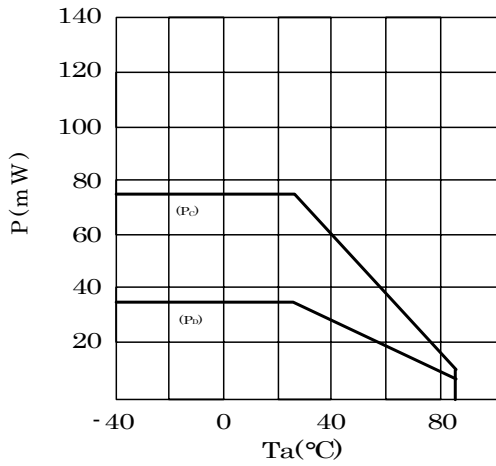

Ic IF Characteristics

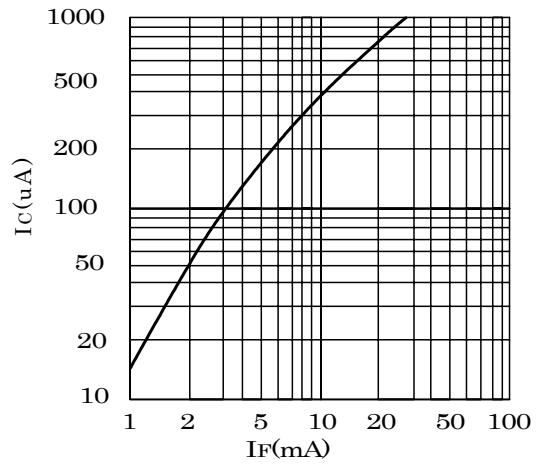

IF VF Characteristics

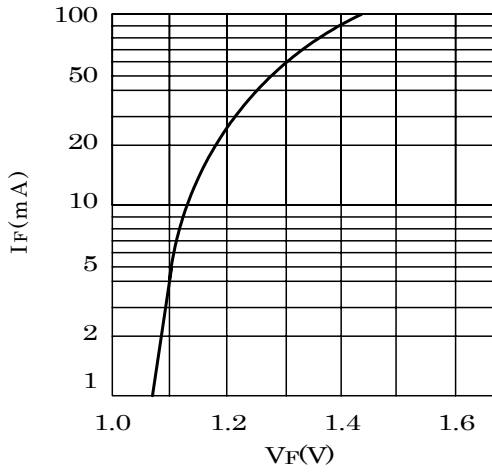

VF Ta Characteristics

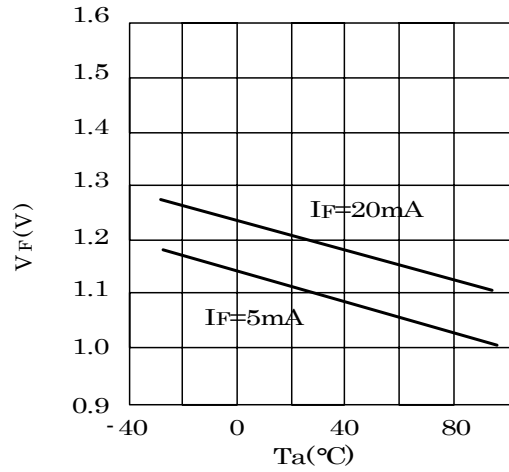

Ic VCE Characteristics

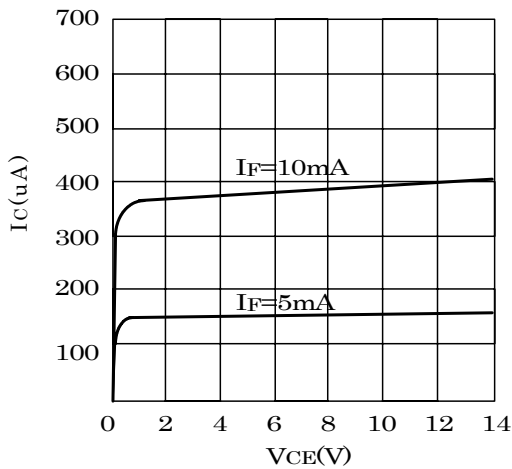

Ic Ta Characteristics

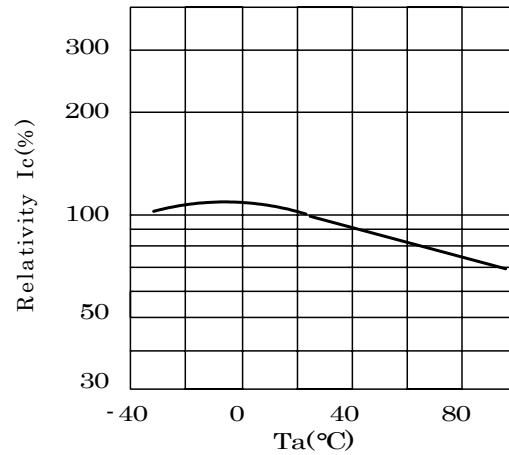

			Approved	Checked	Drawn	Symbol	PHOTO-INTERRUPTER
						Name	CPI-210
						Drawing No	
Mark	Date	Description	Appro.	CITIZEN ELECTRONICS CO.,LTD.			

Reference

ICEO-Ta Characteristics

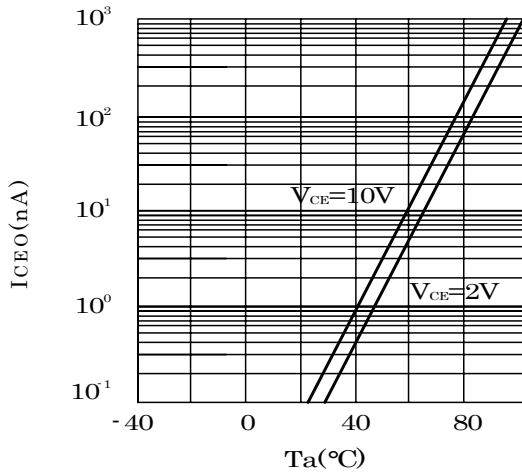

IC-d Characteristics

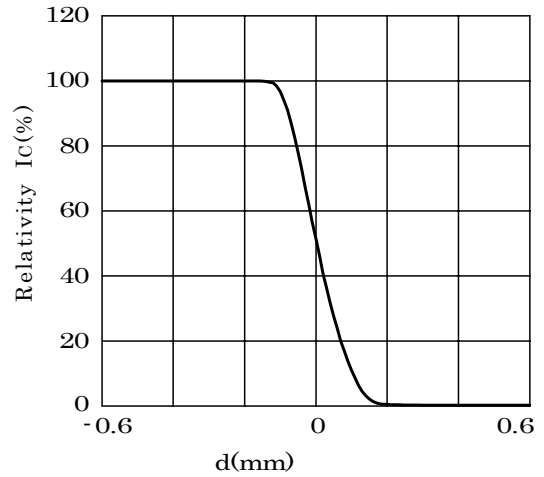

IC-L Characteristics

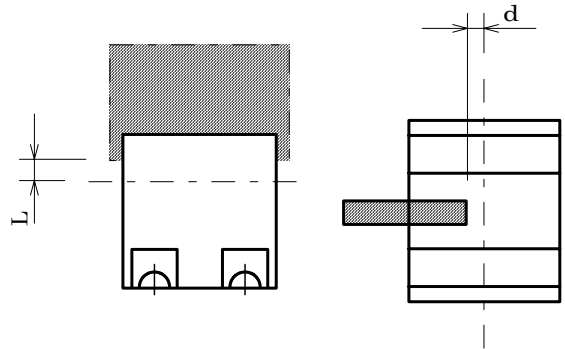
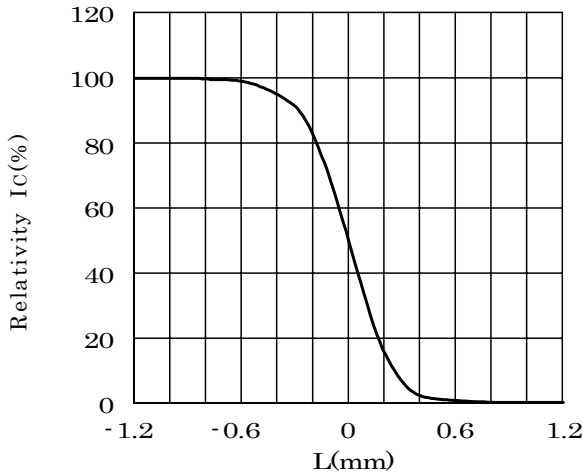

tr,tf Characteristics

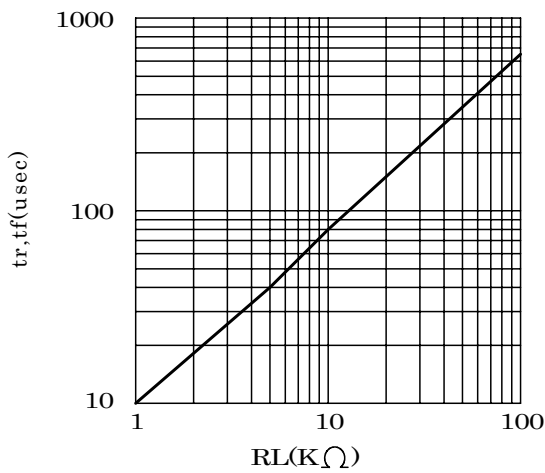

			Approved	Checked	Drawn	Symbol	PHOTO-INTERRUPTER
						Name	CPI-210
						Drawing No	
Mark	Date	Description	Appro.	CITIZEN ELECTRONICS CO.,LTD.			

6. Reliability

Reference

6-1. Details of Test

Test Item	Test Condition
Current Carrying life cycle test	$25^{+5}_{-3}^{\circ}\text{C}$, $I_F=25\text{ mA}$ $V_{CE}=5\text{V}\times 500^{+24}_{-12}$ hours
Low temperature shelf test	$-40^{+3}_{-5}\text{ }^{\circ}\text{C} \times 1000^{+24}_{-12}$ hours
High temperature shelf test	$90^{+5}_{-3}\text{ }^{\circ}\text{C} \times 1000^{+24}_{-12}$ hours
Humidity shelf test	$60 \pm 2^{\circ}\text{C}$, $90 \pm 5\% \text{RH} \times 1000^{+24}_{-12}$ hours
Thermal shock test	$-40^{\circ}\text{C} \times 30\text{ minutes} - 90^{\circ}\text{C} \times 30\text{ minutes}$, 5-cycle
Solder heat resistance test	$260^{\circ}\text{C} \times 1\text{seconds}$ (reflow soldering) or less

6-2. Judgment Criteria of Failure for Reliability Test

Measuring Items	Symbol	Measuring Condition	Judgement Criteria for Failure
Forward voltage	VF	$I_F=5\text{mA}$	$>U \times 1.2$
Reverse current	IR	$V_R=5\text{V}$	$>U \times 2$
Current transfer ratio	IC	$I_F=5\text{mA}, V_{CE}=5\text{V}$	$<S \times 0.7$
Collector dark current	ICEO	$V_{CE}=10\text{V}$	$>U \times 2$

U means the upper limit of the specified characteristics. S means the initial value.

Note: Measurement shall be taken between 2 hours and 24 hours, having returned the test pieces to the normal ambient conditions after the completion of each test.

			Approved	Checked	Drawn	Symbol	PHOTO-INTERRUPTER
						Name	CPI series
						Drawing No	
Mark	Date	Description	Appro.	CITIZEN ELECTRONICS CO.,LTD.			

Reference

7. Taping specifications (In accordance with JIS C 0806-3)

7-1. Dimensions and shape

(Unit: mm)

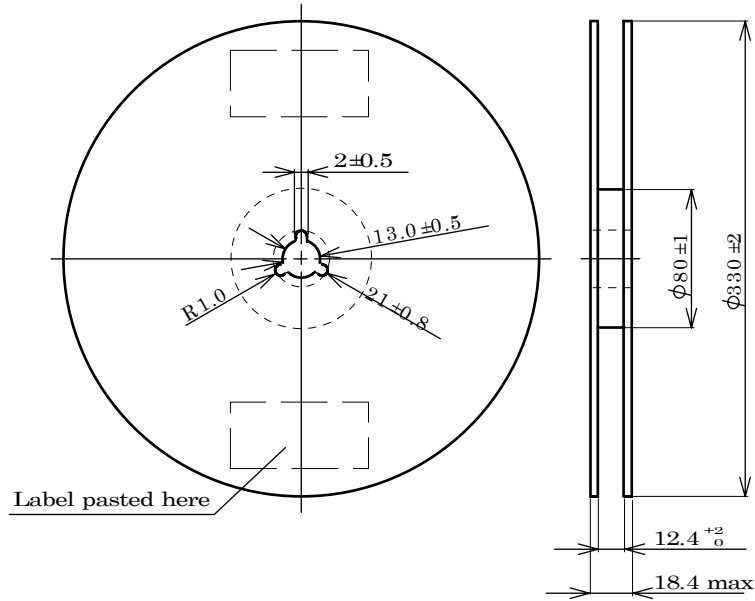

7-2. Dimensions of Tape

(Unit: mm)

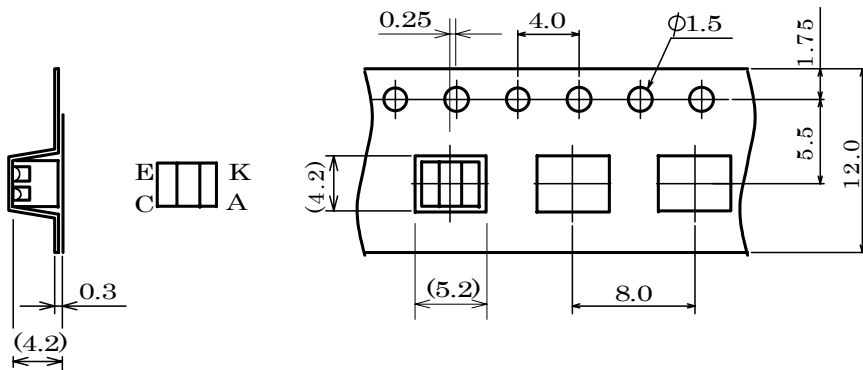

7-3. Configuration of Tape

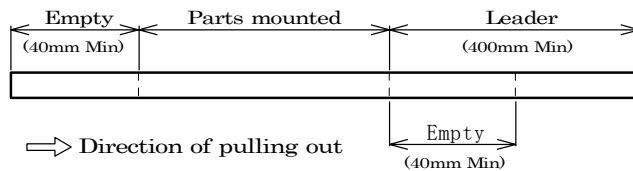

7-4. Quantity : 2,000pcs/reel

7-5. Net weight : 0.1g/Piece 600g/reel

			Approved	Checked	Drawn	Symbol	PHOTO-INTERRUPTER
						Name	CPI-210
						Drawing No	
Mark	Date	Description	Appr.	CITIZEN ELECTRONICS CO.,LTD.			

Reference

8. Packing Specifications

8-1. Moisture-proof Packing

To prevent moisture absorption during transportation and storage, reels are packed in aluminum envelopes which contain a desiccant with a humidity indicator. The indicator changes color from blue to pink as moisture is absorbed.

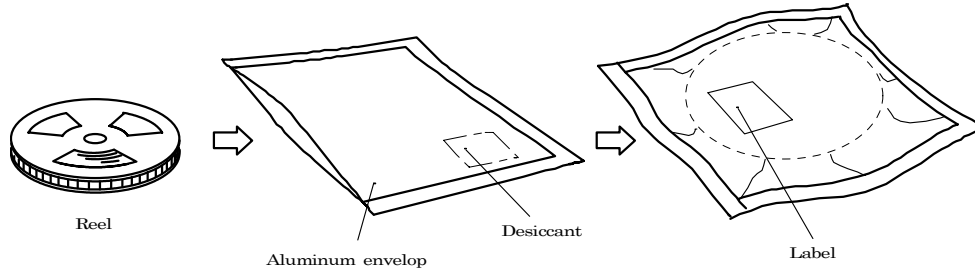

8-2. Storage

To prevent moisture absorption, it is strongly recommended that reels (in bulk or taped) should be stored in the dry box (or the desiccator) with a desiccant as the appropriate storage place. If not, the following is recommended.

Temperature: 10 ~ 30 °C
 Humidity: 60%RH max.

It is recommended to solder photo-interrupters as soon as possible after unpacking the aluminum envelope, but in case that photo-interrupters have to be left unused after unpacking, to store them in the dry box or to seal the aluminum envelope again is requested.

8-3. Baking

If photo-interrupters packed in an aluminum envelope is stored over 6 months, or if it passes more than 48 hours after aluminum envelope is opened, it is requested to make baking per following conditions.

Baking conditions: 60°C × 12 hours or more (reeled one)
 80°C × 4 hours or more (loose one)

				Approved	Checked	Drawn	Symbol	PHOTO-INTERRUPTER
							Name	CPI series
							Drawing No	
Mark	Date	Description	Appro.	CITIZEN ELECTRONICS CO.,LTD.				

Reference

9. Precautions to be taken

9-1. Precautions on designing

- 1) Current limiting resistor should be placed in the circuit so that is driven within its rating Also avoid reverse voltage(overcurrent) applied instantaneously when ON or OFF.
- 2) When pulse driving current is applied, average current consumption should be within the rating.

9-2. Precautions to be taken on mounting

9-2-1. Lead free soldering

- 1) Following soldering paste is recommended.
 Melting temperature: 216 ~ 220°C.
 Composition: Sn 3.5Ag 0.75Cu
- 2) Recommended thickness of metal mask is between 0.2 mm and 0.25 mm for screen printing.
- 3) The below illustrated temperature profile at the top surface of the products is requested for soldering.

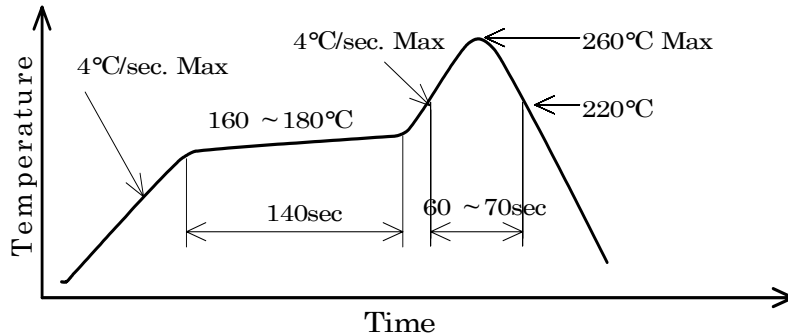

9-2-2. Manual soldering

- 1) SN60(60% tin and 40% lead) or solder with silver content is recommended.
- 2) The use of a soldering iron of less than 25W and the temperature of iron tip must be Kept at no higher than 350°C
- 3) It is requested to solder one land within 3 seconds.
- 4) It is requested that products should be handled after their temperature has dropped down to the normal room temperature.

9-2-3. Washing

- 1) When washing after soldering is needed, following conditions are requested.
 - Washing solvent : Alcohol
 - Temperature and time : 50°C or less×30 seconds max.
or 30°C or less × 3 minutes max.
 - Ultrasonic washing : 300W max

			Approved	Checked	Drawn	Symbol	PHOTO-INTERRUPTER
						Name	CPI series
						Drawing No	
Mark	Date	Description	Appro.	CITIZEN ELECTRONICS CO.,LTD.			

Reference

10. Out line drawing

Unit:mm
Tolerance:±0.15

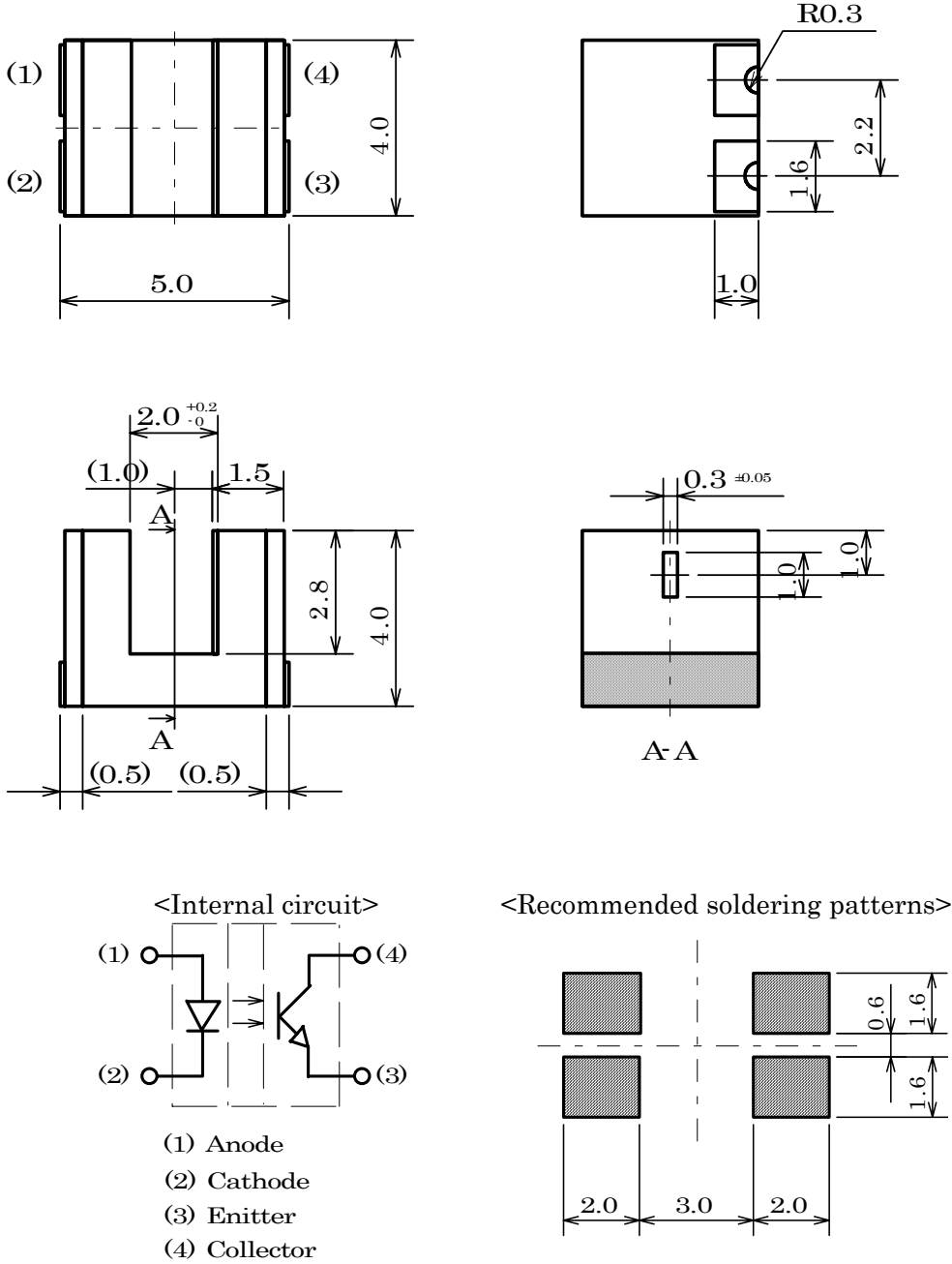

Finish of soldering terminal : Au Plating

			Approved	Checked	Drawn	Symbol	PHOTO-INTERRUPTER
						Name	CPI-210
						Drawing No	
Mark	Date	Description	Appro.	CITIZEN ELECTRONICS CO.,LTD.			