

※This is a RoHS and REACH compliant product whose related documents are available on request.

※Graphic is only for dimensionally application.

1. PART NUMBERING IDENTIFICATION

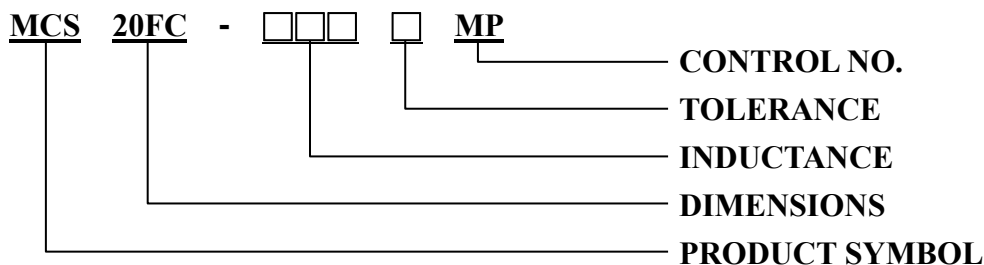

2. MECHANICAL DIMENSION

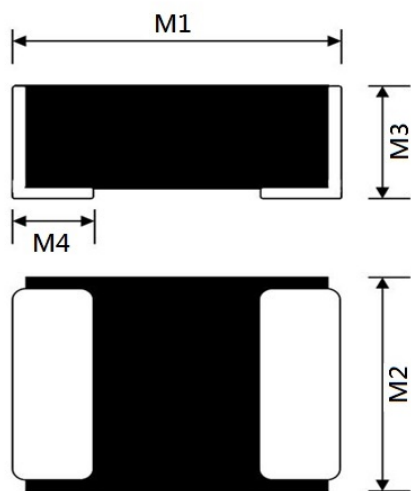

UNIT: mm

	DIM.	TOL.
M1	2.0	±0.2
M2	1.6	±0.2
M3	1.0	MAX.
M4	0.5	±0.3

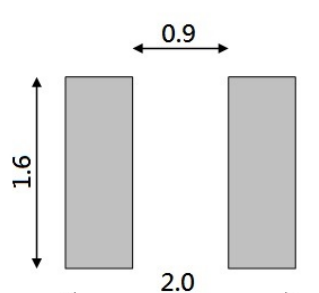

3. ELECTRICAL SPECIFICATION

Part number	Inductance (μ H) ±20%	DC Resistance (m Ω) Typical	DC Resistance (m Ω) MAX.	Irms (A) Typical	Irms (A) MAX.	I sat (A) Typical	I sat (A) MAX.
MCS20FC-R24MMP	0.24	17	21	5.0	4.50	5.6	5.05
MCS20FC-R33MMP	0.33	24	29	4.1	3.69	5.0	4.50
MCS20FC-R47MMP	0.47	33	40	3.5	3.15	4.4	4.00
MCS20FC-R68MMP	0.68	41	49	3.4	3.06	3.7	3.33
MCS20FC-1R0MMP	1.0	60	69	2.6	2.26	2.9	2.61
MCS20FC-1R5MMP	1.5	114	129	2.0	1.81	2.5	2.25
MCS20FC-2R2MMP	2.2	135	150	1.7	1.50	1.9	1.71

NOTE:

1. Test Freq.: 1MHz, 1V
2. All test referenced to 26°C ambient.
3. Operating Temperature range: -40°C to +125°C
4. Storage Temperature range: -50°C to +125°C
5. Isat means that DC current will cause a 30% inductance reduction from initial value.
6. Irms means that DC current will cause coil temp. rising to 40°C whichever is smaller.

SPECIFICATION FOR APPROVAL

4. ELECTRICAL CURVE

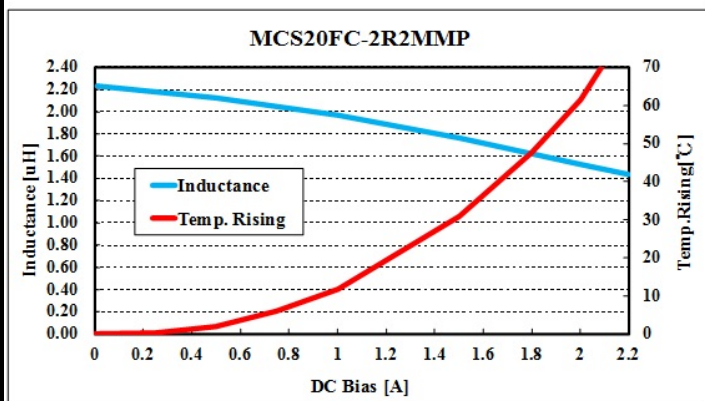
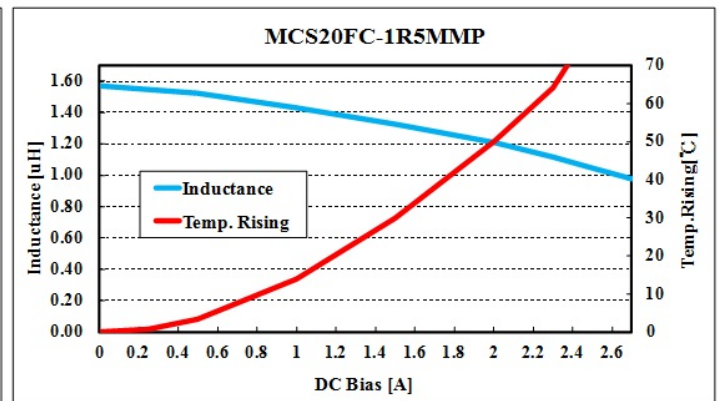
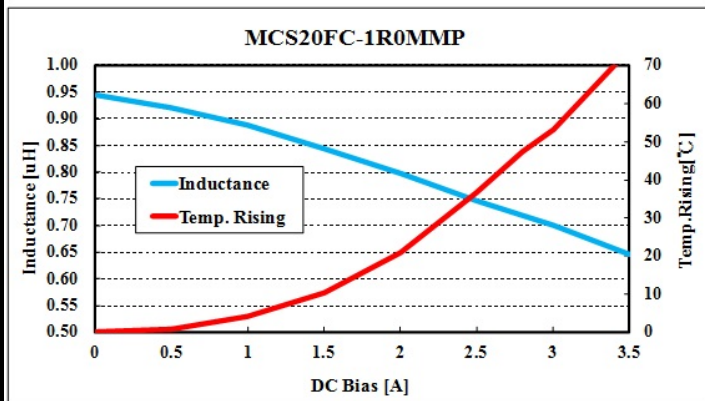
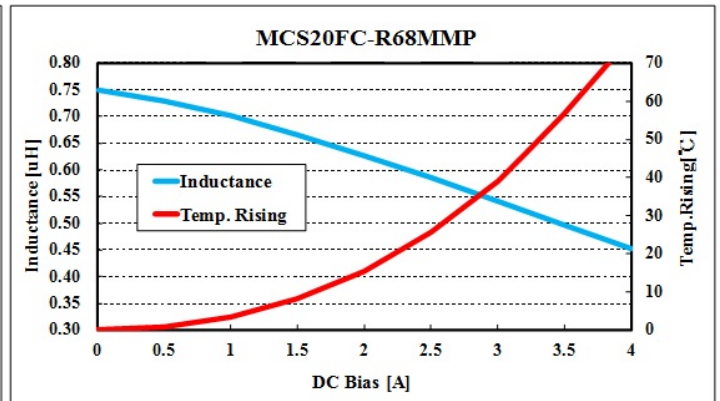
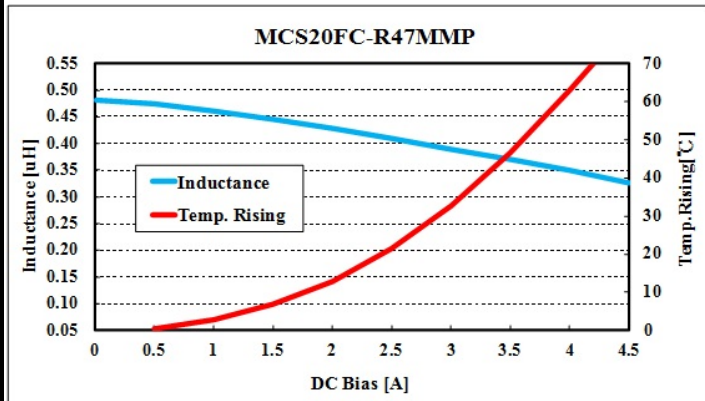
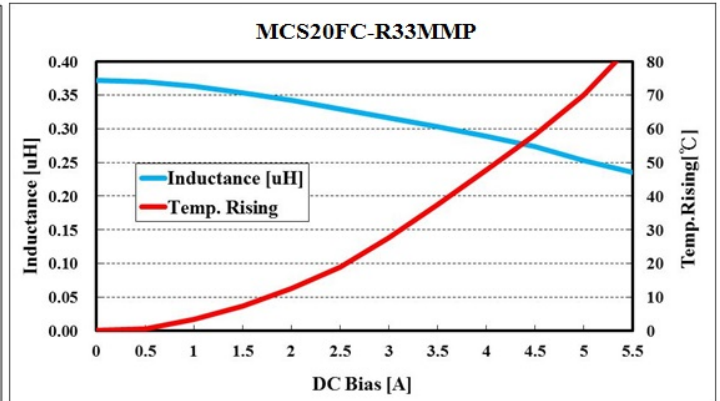
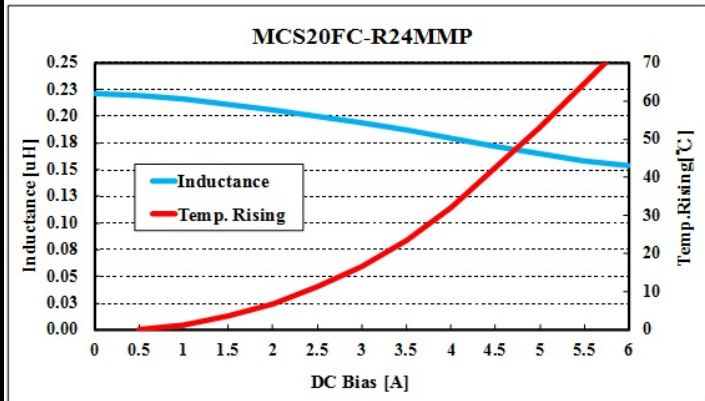

SPECIFICATION FOR APPROVAL

5. PACKING

5.1 Carrier tape dimensions

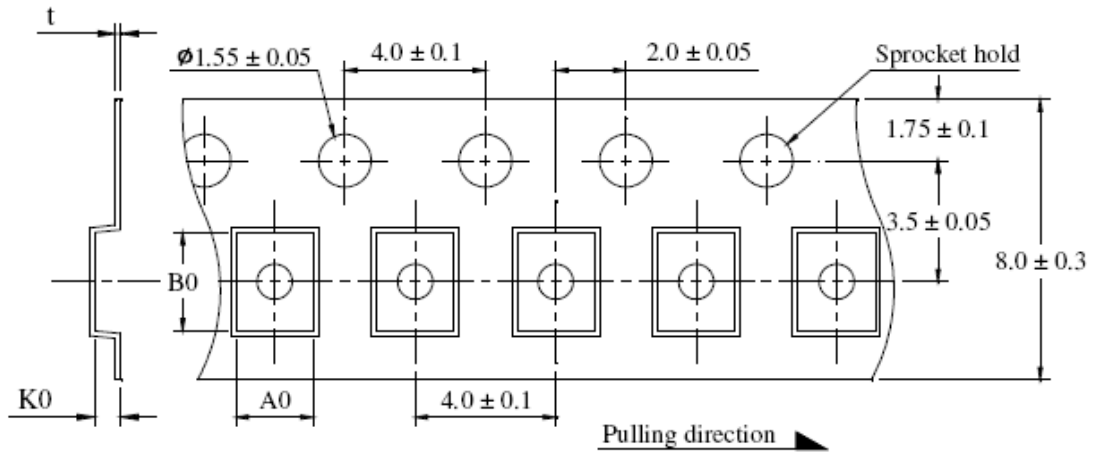

UNIT : mm

	A0	B0	K0	t
DIM.	1.80±0.1	2.20±0.1	1.15±0.1	0.22±0.05

5.2 Taping reel dimensions

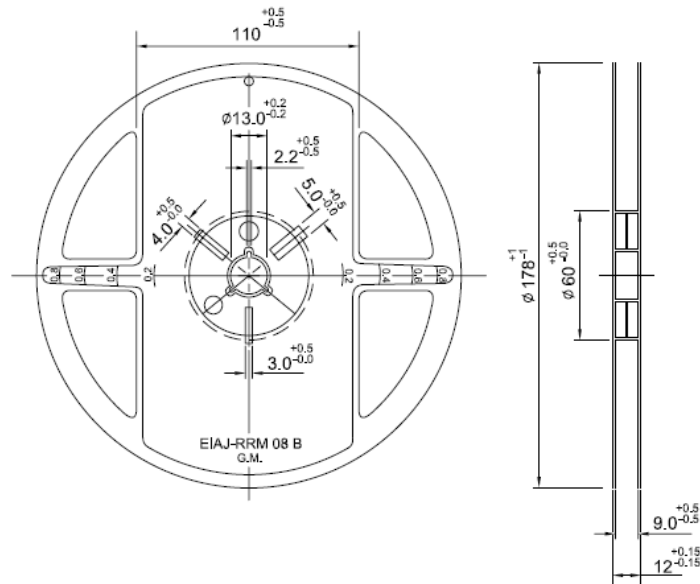

Qty.(pcs)	3,000
BOX	5 reels / inner box